

Heat & Glo

MSRP Price Book
Table of Contents

Heat & Glo

Fireplace - Gas - Single-Sided

| | |
|--|----|
| 6K | 4 |
| 6K Modern | 8 |
| 6KL | 11 |
| 6KX | 14 |
| 8K | 17 |
| 8K Modern | 20 |
| 8KL | 23 |
| 8KX | 26 |
| Cerona 36 | 29 |
| Cerona 42 | 31 |
| COSMO 32 | 33 |
| COSMO 36 | 36 |
| COSMO 42 | 39 |
| MEZZO 36 | 42 |
| MEZZO 48 | 45 |
| MEZZO 60 | 48 |
| MEZZO 72 | 51 |
| Primo II 48 | 54 |
| Primo II 60 | 57 |
| Primo II 72 | 60 |
| SlimLine 3X | 63 |
| SlimLine 5 w/ IFT | 65 |
| SlimLine 5X | 68 |
| SlimLine 7 w/ IFT | 71 |
| SlimLine 7X | 74 |
| SlimLine 9 w/ IFT | 77 |
| SlimLine 9X | 80 |
| SlimLine Fusion 5 w/ IFT | 83 |
| SlimLine Fusion 7 w/ IFT | 86 |
| TRUE 36 IFT | 89 |
| TRUE 42 IFT | 92 |
| TRUE 50 IFT | 95 |

Fireplace - Gas - TrueView

| | |
|----------------------------|----|
| Phoenix 42 | 98 |
|----------------------------|----|

Fireplace - Gas - Freestanding

| | |
|--|-----|
| Supreme Freestanding 30" | 101 |
|--|-----|

Fireplace - Gas - Multi-Sided

| | |
|--|-----|
| Escape See-Through IFT | 103 |
| MEZZO 36 See-Through | 106 |
| MEZZO 48 See-Through | 109 |

Fireplace - Gas - Multi-Sided-cont'd

| | |
|--------------------------------------|-----|
| MEZZO 60 See-Through | 112 |
| MEZZO 72 See-Through | 115 |
| Primo II 48ST | 118 |
| Primo II 60ST | 121 |
| Primo II 72ST | 124 |

Fireplace - Wood - Single-Sided

| | |
|---------------------------------|-----|
| Exclaim 36 | 127 |
| Exclaim 42 | 131 |
| Exclaim 50 | 135 |
| Northstar | 139 |
| Royal Hearth 36 | 141 |
| Royal Hearth 42 | 144 |
| Rutherford 36 | 147 |
| Rutherford 42 | 150 |
| Rutherford 50 | 152 |

Insert - Gas

| | |
|--------------------------------------|-----|
| Cosmo Insert 30" | 154 |
| Cosmo Insert 35" | 157 |
| Escape-30 | 160 |
| Escape-35 | 163 |
| Provident Insert 30" | 166 |
| Provident Insert 35" | 168 |
| Supreme Insert 25" | 170 |
| Supreme Insert 30" | 173 |
| Supreme Insert 35" | 176 |

Hearth & Home Technologies

Gas Logs - Log Set Option

| | |
|--|-----|
| Campfire Gas Log Sets | 179 |
| Fireside Grand Oak Gas Log Sets | 180 |
| Fireside Grand Oak Outdoor Gas Log Sets | 181 |
| Fireside Realwood Gas Log Sets | 182 |
| Fireside Supreme Oak Gas Logs | 183 |
| Fireside Supreme Oak See-Through Gas ... | 184 |

Gas Logs - Burner Option Indoor

| | |
|--|-----|
| 2-Tier Stadium - Vented Burner 18" | 185 |
| 2-Tier Stadium - Vented Burner 24" | 186 |
| 2-Tier Stadium - Vented Burner 30" | 187 |
| 3-Tier Stadium - Vented Burner 18" | 188 |
| 3-Tier Stadium - Vented Burner 24" | 189 |
| 3-Tier Stadium - Vented Burner 30" | 190 |
| Contemporary Vented Burner 24" | 191 |

| | | | |
|--|-----|---|-----|
| Gas Logs - Burner Option Indoor-cont'd | | Venting-cont'd | |
| Contemporary Vented Burner 30" | 192 | Wood Fireplace - 14" DuraChimney II V... | 235 |
| Double Tube - Vented Burner 18" | 193 | Wood Fireplace - SL1100 Series Venting | 235 |
| Double Tube - Vented Burner 24" | 194 | Wood Fireplace - SL300 Series Venting | 237 |
| Double Tube - Vented Burner 30" | 195 | Wood Fireplace - SL400 Series Venting | 238 |
| Fireside Realwood Outdoor Gas Log Sets | 196 | Wood Insert Venting | 239 |
| Radiant Burner 18/24" | 197 | Wood Stove Venting | 240 |
| Radiant Burner 30" | 198 | Venting - HHT | 243 |
| Single Tube - Vented Burner 18" | 199 | Termination Kits | |
| Single Tube - Vented Burner 24" | 201 | Termination Kits | 245 |
| Single Tube - Vented Burner 30" | 203 | Hearth & Home Technologies | |
| Gas Logs - Burner Option Outdoor | | Fireplace - Gas - Single-Sided | |
| Lumnessen Outdoor | 205 | DV Linear 36 | 247 |
| Outdoor 2-Tier Stadium Vented Burner 18" | 207 | DV3732 | 249 |
| Outdoor 2-Tier Stadium Vented Burner 24" | 208 | DV4236 | 250 |
| Outdoor 2-Tier Stadium Vented Burner 30" | 209 | Reveal 36 | 251 |
| Outdoor 3-Tier Stadium Vented Burner 18" | 210 | Reveal 42 | 253 |
| Outdoor 3-Tier Stadium Vented Burner 24" | 211 | Fireplace - Gas - Multi-Sided | |
| Outdoor 3-Tier Stadium Vented Burner 30" | 212 | Corner Gas Fireplace L/R-COR | 255 |
| Outdoor Single Tube - Vented Burner 18" | 213 | Pier 36 | 257 |
| Outdoor Single Tube - Vented Burner 24" | 214 | See Through 36 | 260 |
| Hearth & Home Technologies | | Fireplace - Wood - Single-Sided | |
| Power Vent | | Pioneer II | 263 |
| Power Vent | 215 | Pioneer III | 265 |
| Powervent | 215 | Fireplace Outdoor - Gas - Single-Sided | |
| Power Vent Accessories | 216 | Courtyard 36 | 267 |
| Wire Harness | | Courtyard 42 | 269 |
| Wire Harness | 217 | Lanai 48 | 271 |
| Venting | | Lanai 60 | 273 |
| Air Kits | 218 | Vesper 36 | 275 |
| Decorative Termination Caps/Shrouds | 218 | Vesper 42 | 277 |
| 8" DuraPlus Pipe | 218 | Fireplace Outdoor - Wood - Single-Sided | |
| Fireplace - Wood & Coal Venting | 219 | Castlewood 42 | 279 |
| Gas Fireplace - 6" B-Vent | 219 | Cottagewood 36 | 281 |
| Gas Fireplace - 8" B-Vent | 221 | Cottagewood 42 | 283 |
| Gas Fireplace - 10" B-Vent | 222 | Villawood 36 | 285 |
| Gas Fireplace - DVP Venting | 223 | Villawood 42 | 287 |
| Gas Fireplace - Flex Venting | 225 | Fireplace Outdoor - Gas - Multi-Sided | |
| Gas Fireplace - Term./Shrouds | 225 | Fortress 36 Indoor/Outdoor See-Through... | 289 |
| Gas Fireplace/Stove - SLP Venting | 226 | Lanai 48 See-Through | 291 |
| Gas Insert - Venting | 228 | Twilight Indoor/Outdoor See-Through G... | 293 |
| Outside Kits | 229 | Twilight Modern | 295 |
| SLP and DVP - Shield/Flashing/Collars | 229 | Hearth & Home Technologies | |
| Stove & Insert - Pellet | 229 | Mantels - Flush Wood | |
| Venting - VCG | 233 | Acadia A | 297 |
| Stove - Pellet Chimney | 234 | Acadia B | 297 |
| Venting - VMT | 234 | Acadia C | 297 |
| Stoves & inserts - Wall Pass Thru | 234 | Battlefield B | 298 |
| Top Vent option | 234 | Battlefield C | 298 |

Mantels - Flush Wood-cont'd

| | |
|------------------------------|-----|
| Corbels | 298 |
| Kenwood A | 298 |
| Kenwood B | 298 |
| Kenwood B60 | 299 |
| Kenwood C | 299 |
| Laurel B | 299 |
| Laurel C | 299 |
| Malone B | 300 |
| Malone C | 300 |
| Merritt A | 300 |
| Merritt B | 300 |
| Merritt C | 300 |
| Richland A | 301 |
| Richland B | 301 |
| Richland C | 301 |
| Richland RS | 301 |
| Roxborough A | 301 |
| Roxborough B | 302 |
| Roxborough C | 302 |
| Walker B | 302 |
| Walker C | 302 |
| Wescott A | 302 |
| Wescott B | 303 |
| Wescott C | 303 |
| Zimmer A | 303 |
| Zimmer B | 303 |
| Zimmer C | 303 |

Optional Wood Mantel Base

| | |
|--|-----|
| Kenwood A Flush Mantel Base | 305 |
| Kenwood B Flush Mantel Optional Base | 305 |
| Kenwood C Flush Mantel Optional Base | 305 |

Samples - Wood Mantel Shoulder

| | |
|---|-----|
| Acadia Mantel Sample | 306 |
| Battlefield Mantel Sample | 306 |
| Kenwood Wood Mantel Sample - Primed MDF | 306 |
| Laurel Mantel Sample | 306 |
| Malone Mantel Sample | 306 |
| Merritt Mantel Sample | 307 |
| Richland Mantel Sample | 307 |
| Roxborough Mantel Sample | 307 |
| Walker Mantel Sample | 307 |
| Wescott Mantel Sample | 307 |
| Zimmer Mantel Sample | 307 |

Samples - Non-Combustible Shelf Shoulder

| | |
|---|-----|
| Non-Combustible Cove Gray 18" | 309 |
| Non-Combustible Midnight Mist 18" | 309 |
| Non-Combustible Tavern Brown 18" | 309 |
| Non-Combustible Washed Cedar 18" | 309 |

Samples - Non-Combustible Shelf Shoulder-cont'd

| | |
|--|-----|
| Non-Combustible Weathered Barnwood 18" | 309 |
| Non-Combustible White 18" | 310 |

Mantels - Shelf Wood

| | |
|------------------------------|-----|
| Baxter 48" | 311 |
| Baxter 59" | 311 |
| Baxter 72" | 311 |
| Crosby 48" | 312 |
| Crosby 59" | 312 |
| Crosby 72" | 312 |
| Fillmore 48" | 312 |
| Fillmore 59" | 312 |
| Fillmore 72" | 313 |
| Ozark 48" | 313 |
| Ozark 59" | 313 |
| Ozark 72" | 313 |

Shelf Non-Combustible

| | |
|--|-----|
| Non-Combustible Cove Gray 60" | 314 |
| Non-Combustible Cove Gray 72" | 314 |
| Non-Combustible Midnight Mist 60" | 314 |
| Non-Combustible Midnight Mist 72" | 314 |
| Non-Combustible Tavern Brown 60" | 314 |
| Non-Combustible Tavern Brown 72" | 315 |
| Non-Combustible Washed Cedar 60" | 315 |
| Non-Combustible Washed Cedar 72" | 315 |
| Non-Combustible Weathered Barnwood 60" | 315 |
| Non-Combustible Weathered Barnwood 72" | 315 |
| Non-Combustible White 60" | 316 |
| Non-Combustible White 72" | 316 |

Samples - Wood Shelf Mantel

| | |
|---------------------------------------|-----|
| Baxter Shelf Sample | 317 |
| Crosby Shelf Sample | 317 |
| Fillmore Shelf Sample | 317 |
| Ozark Shelf Sample | 317 |

Marble, Granite & Slate

| | |
|--|-----|
| Absolute Black Granite Set 1 | 318 |
| Absolute Black Granite Set 2 | 318 |
| Absolute Black Set 3 | 318 |
| Beige Marble Set 1 | 319 |
| Beige Marble Set 2 | 319 |
| Beige set 3 | 319 |
| Bianco White set 1 | 319 |
| Bianco White set 2 | 319 |
| Bianco White set 3 | 320 |
| Blue Tundra set 1 | 320 |
| Blue Tundra set 2 | 320 |
| Blue Tundra set 3 | 320 |
| Driftwood 55 x 6 Linear Header, Riser | 320 |
| Driftwood 75.25 x 6 Linear Header, riser | 321 |

Heat & Glo

Fireplace - Gas - Single-Sided

Stocked Item/Lead Time
 004=Mt. Pleasant RDC
 010=Kutztown RDC
 014=Sacramento RDC
 016=Charlotte RDC
 EXP=Factory Expedite Program

Prices in USD

Page printed 3/31/2025, 8:22:26 AM CDT
 Current pricing updated 03/30/2025
 * Please Contact Who You Purchase This Through for MSRP Pricing

Non-stock and custom product cannot be cancelled.

Customer is responsible for freight for orders made outside of assigned RDC facility.

6K

Includes:

- 16,000 - 30,000 Btu/Hour Input (NG) • IntelliFire Touch Ignition System
- 17,000 - 29,000 Btu/Hour Input (LP)
- 12 ft Wall switch wire
- Tempered glass
- 6 ceramic fiber logs
- Battery backup
- Glowing embers
- Ceramic Fiber Burner Top



Special Considerations:

- Flame adjustment requires RC400 or IFT-WFM

Required to Complete - Sold Separately: • Front

| | | Disc. Code | MSRP USD | 004 IA | 010 PA | 014 CA | 016 NC | EXP |
|-------|---|------------|----------|--------|--------|--------|--------|-----|
| 6K | 6K 36" Direct Vent Gas Fireplace Top/Rear Vent with IntelliFire Touch ignition (NG) | HNG 1 | \$ 3,129 | Y | Y | Y | Y | N |
| 6K-LP | 6K 36" Direct Vent Gas Fireplace Top/Rear Vent with IntelliFire Touch ignition (LP) | HNG 1 | \$ 3,199 | Y | Y | Y | Y | N |

Fronts (Required to Complete)

Folio

| | | | | | | | | |
|------------|--------------------------------|-------|--------|---|---|---|---|---|
| FOLIO-6-BK | Folio inside fit front - Black | HNG 1 | \$ 369 | Y | Y | Y | Y | Y |
|------------|--------------------------------|-------|--------|---|---|---|---|---|

Studio

| | | | | | | | | |
|-------------|-----------------------------------|-------|--------|---|----|---|----|---|
| STUDIO-6-BK | Studio overlap front - Black | HNG 1 | \$ 639 | Y | Y | Y | Y | Y |
| STUDIO-6-GM | Studio overlap front - Gun Metal | HNG 1 | \$ 689 | Y | 14 | Y | 14 | Y |
| STUDIO-6-NB | Studio overlap front - New Bronze | HNG 1 | \$ 689 | Y | 14 | Y | 14 | Y |

Portrait

| | | | | | | | | |
|---------------|--|-------|----------|---|----|----|----|---|
| PORTRAIT-6-BK | Portrait clean face overlap front - Black (note mantel or Passive Heat requirements) | HNG 1 | \$ 1,049 | Y | Y | Y | Y | Y |
| PORTRIM6-BR | Optional plated trim for Portrait front - Burnished Brass | HNG 1 | \$ 529 | Y | 14 | Y | 14 | Y |
| PORTRIM6-CO | Optional plated trim for Portrait front - Vintage Copper | HNG 1 | \$ 529 | Y | 14 | 14 | 14 | Y |
| PORTRIM6-NI | Optional plated trim for Portrait front - Satin Nickel | HNG 1 | \$ 529 | Y | 14 | 14 | 14 | Y |

Loft

| | | | | | | | | |
|-----------|--|-------|----------|---|----|----|----|---|
| LOFT-6-BK | Loft barn door overlap front with ClearVue mesh - Black | HNG 1 | \$ 1,049 | Y | Y | Y | Y | Y |
| LOFT-6-GM | Loft barn door overlap front with ClearVue mesh - Gun Metal | HNG 1 | \$ 1,099 | Y | Y | 14 | 14 | Y |
| LOFT-6-NB | Loft barn door overlap front with ClearVue mesh - New Bronze | HNG 1 | \$ 1,099 | Y | 14 | 14 | 14 | Y |

| Chapel | | | | | | | | | |
|-------------|---|-------|----------|---|----|----|----|---|--|
| CHAPEL-6-BK | Chapel arched overlap front with ClearVue mesh - Black | HNG 1 | \$ 1,159 | Y | Y | 14 | 14 | Y | |
| CHAPEL-6-GM | Chapel arched overlap front with ClearVue mesh - Gun Metal | HNG 1 | \$ 1,209 | Y | 14 | 14 | 14 | Y | |
| CHAPEL-6-NB | Chapel arched overlap front with ClearVue mesh - New Bronze | HNG 1 | \$ 1,209 | Y | 14 | Y | 14 | Y | |

| Forge | | | | | | | | | |
|---------|---|-------|----------|---|---|---|---|---|--|
| FORGE-6 | Forge hand-crafted overlap front with ClearVue mesh | HNG 1 | \$ 2,259 | Y | Y | Y | Y | Y | |



Folio



Studio



Portrait



Loft



Chapel



Forge

| Liner Kit | | | | | | | | | |
|------------------|---|-------|--------|---|----|----|----|---|--|
| Brick Refractory | | | | | | | | | |
| BRICK-6K-SJ | Serene Jute, 3 piece large traditional brick refractory | HNG 1 | \$ 369 | Y | 42 | 42 | 42 | Y | |
| BRICK-6K-CU | Calm Umber, 3 piece traditional brick refractory | HNG 1 | \$ 369 | Y | 14 | 14 | 14 | Y | |
| BRICK-6K-TG | Tranquil Greige, 3 piece herringbone brick refractory | HNG 1 | \$ 399 | Y | 21 | 21 | 21 | Y | |

| Liner Kit Black Glass Liner - 2 Sided | | | | | | | | | |
|---------------------------------------|---|-------|--------|---|----|----|----|---|--|
| GL-36M | 3 Pc - 2-Sided Reflective Black Glass/Matte Glass Liner | HTI 1 | \$ 969 | Y | 14 | 14 | 14 | Y | |

| Fans | | | | | | | | | |
|----------|--|-------|--------|---|---|---|---|---|--|
| Fan | | | | | | | | | |
| GFK-160C | Fan kit 160 CFM (fan only) | HTI 1 | \$ 259 | Y | Y | Y | Y | Y | |
| GFK-160A | Fan kit 160 CFM (includes rheostat and temperature sensor) | HTI 1 | \$ 319 | Y | Y | Y | Y | Y | |

| Ceramic Log | | | | | | | | | |
|-------------|---------------|-------|--------|---|---|----|----|---|--|
| Birch Logs | | | | | | | | | |
| LOGS-6-BIR | Birch Log set | HNG 1 | \$ 689 | Y | Y | 14 | 14 | Y | |

| Heat Management | | | | | | | | | |
|-----------------|--|-------|--------|---|---|---|----|---|--|
| Heat Management | | | | | | | | | |
| PH-SIDETRIM | Passive Heat trim kit for side discharge (includes 2 side registers)(Starting collars sold separately) | HTI 1 | \$ 110 | Y | Y | Y | Y | Y | |
| PH-FRTRIM-36 | Passive Heat Vent Trim Kit For Front Discharge (36")(Starting collars sold separately) | HTI 1 | \$ 209 | Y | Y | Y | 21 | Y | |
| PH-MR | Passive Heat Kit starting collars (requires a side or front trim kit or use open top chase) | HTI 1 | \$ 269 | Y | Y | Y | Y | Y | |

| Heat Out Kit | | | | | |
|---|---|-------|----------|---|-----------|
| HEAT-OUT-GAS | Heat out kit (includes termination cap, 25' of 6" round duct, fireplace adapter, damper, wall switch and 350CFM fan at termination) | HTI 1 | \$ 1,529 | Y | 14 Y 14 Y |
| Heat Zone Kit | | | | | |
| HZMR-ADP | Required adaptor for HEAT-ZONE-GAS when not being paired with Passive Heat | HTI 0 | \$ 104 | Y | Y Y 14 Y |
| HEAT-ZONE-GAS | Heat-Zone Kit includes fan, 20' of 6" round duct, vent, wall adapter & on/off control. Wire Plug Assembly 26D0619 required if controlling w/RC400 remote. Used in IFT units with ACM & not a GFK fan. Compatible for up to 2 HEAT-ZONE-GAS kits. See manual. | HTI 1 | \$ 569 | Y | Y Y Y Y |
| Control, remotes, wall switches | | | | | |
| Battery Back Up | | | | | |
| BATTERY-WSK | Battery backup wall switch kit for units with IFT control systems. Includes: On/Off Wall Switch, USB-C Port, Battery Backup, Cover Plate, 12' Wire Harness | HTI 1 | \$ 189 | Y | 14 Y 14 Y |
| IntelliFire app | | | | | |
| IFT-WFM | IntelliFire Wi-Fi Module that works with the IntelliFire iOS and Android app. Use to control all the features of your fireplace via a smart device. An RC400, RC450 or RC150 is required for thermostat control | HTI 1 | \$ 229 | Y | Y Y Y Y |
| IntelliFire Touch Controls - Aux Module | | | | | |
| IFT-ACM | IntelliFire Touch AUX Module. Must order if adding Fan, Lights or Power Vent and want to use the IFT-WFM. Do not need to order if using IFT-RC400 (includes IFT-ACM). | HTI 1 | \$ 98 | Y | Y 14 14 Y |
| Touch Screen Remote | | | | | |
| IFT-RC400 | IntelliFire Touch black remote control, docking station and auxiliary control module (on/off, flame height, thermostat mode, fan control, child lock, cold climate, timer mode, hot indicator, lights, on-screen maintenance and troubleshooting notifications) | HTI 1 | \$ 389 | Y | Y Y Y Y |
| Wall Switch | | | | | |
| IFT-RC150-HNG | IntelliFire Touch white wireless wall switch (on/off, cold climate, battery strength indicator) | HNG 1 | \$ 121 | Y | Y Y Y Y |



Battery Back Up



IntelliFire app

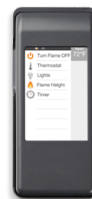

Touch Screen Remote



Wall Switch

Venting

| Brick Extension Kit | | | | | |
|---------------------|--|-------|-------|---|------------|
| HEAT-OUT-BEK | Exterior Heat-Zone brick extension kit | HTI 1 | \$ 73 | 8 | 21 21 14 Y |

Venting Notes

Requires 8" DVP pipe.

Approved for use with SLP series pipe. See Venting section of manual. Restrictions apply. See installation manual for venting specifications.

Approved for use with PVL P-SLP, PVI-SLP-B and PVV-SLP with power vent wire harness and IFT-RC400 remote (order separately). See venting section of manual.

6K Modern

Includes:

- 17,000 - 34,000 Btu/Hour Input (NG)
- Virtually invisible anti-reflective ceramic glass
- 2 sided black ceramic glass liner
- 12 ft wall switch wire
- Battery Backup



Special Considerations:

- Flame adjustment requires RC400 or IFT-WFM
- LP is not available for this fireplace

Required to Complete - Sold Separately: • Front • Crushed Glass Media (Qty 2)

| | | Disc. Code | MSRP USD | 004 IA | 010 PA | 014 CA | 016 NC | EXP |
|-------|--|------------|----------|--------|--------|--------|--------|-----|
| 6KMOD | 6K Modern 36" Direct Vent Gas Fireplace top vent (NG) - 2-Sided Reflective Black Glass/Matte Glass Liner | HNG 1 | \$ 4,029 | 14 | 14 | Y | 14 | N |

Fronts (Required to Complete)

Folio

| | | | | | | | | |
|------------|--------------------------------|-------|--------|---|---|---|---|---|
| FOLIO-6-BK | Folio inside fit front - Black | HNG 1 | \$ 369 | Y | Y | Y | Y | Y |
|------------|--------------------------------|-------|--------|---|---|---|---|---|

Studio

| | | | | | | | | |
|-------------|-----------------------------------|-------|--------|---|----|---|----|---|
| STUDIO-6-BK | Studio overlap front - Black | HNG 1 | \$ 639 | Y | Y | Y | Y | Y |
| STUDIO-6-NB | Studio overlap front - New Bronze | HNG 1 | \$ 689 | Y | 14 | Y | 14 | Y |
| STUDIO-6-GM | Studio overlap front - Gun Metal | HNG 1 | \$ 689 | Y | 14 | Y | 14 | Y |

Portrait

| | | | | | | | | |
|---------------|--|-------|----------|---|----|----|----|---|
| PORTRAIT-6-BK | Portrait clean face overlap front - Black (note mantel or Passive Heat requirements) | HNG 1 | \$ 1,049 | Y | Y | Y | Y | Y |
| PORTRIM6-BR | Optional plated trim for Portrait front - Burnished Brass | HNG 1 | \$ 529 | Y | 14 | Y | 14 | Y |
| PORTRIM6-CO | Optional plated trim for Portrait front - Vintage Copper | HNG 1 | \$ 529 | Y | 14 | 14 | 14 | Y |
| PORTRIM6-NI | Optional plated trim for Portrait front - Satin Nickel | HNG 1 | \$ 529 | Y | 14 | 14 | 14 | Y |

Loft

| | | | | | | | | |
|-----------|--|-------|----------|---|----|----|----|---|
| LOFT-6-BK | Loft barn door overlap front with ClearVue mesh - Black | HNG 1 | \$ 1,049 | Y | Y | Y | Y | Y |
| LOFT-6-GM | Loft barn door overlap front with ClearVue mesh - Gun Metal | HNG 1 | \$ 1,099 | Y | Y | 14 | 14 | Y |
| LOFT-6-NB | Loft barn door overlap front with ClearVue mesh - New Bronze | HNG 1 | \$ 1,099 | Y | 14 | 14 | 14 | Y |

Chapel

| | | | | | | | | |
|-------------|---|-------|----------|---|----|----|----|---|
| CHAPEL-6-BK | Chapel arched overlap front with ClearVue mesh - Black | HNG 1 | \$ 1,159 | Y | Y | 14 | 14 | Y |
| CHAPEL-6-GM | Chapel arched overlap front with ClearVue mesh - Gun Metal | HNG 1 | \$ 1,209 | Y | 14 | 14 | 14 | Y |
| CHAPEL-6-NB | Chapel arched overlap front with ClearVue mesh - New Bronze | HNG 1 | \$ 1,209 | Y | 14 | Y | 14 | Y |

Forge

| | | | | | | | | |
|---------|---|-------|----------|---|---|---|---|---|
| FORGE-6 | Forge hand-crafted overlap front with ClearVue mesh | HNG 1 | \$ 2,259 | Y | Y | Y | Y | Y |
|---------|---|-------|----------|---|---|---|---|---|



Folio



Studio

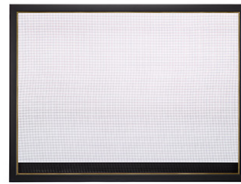

Portrait



Loft



Chapel



Forge

Media (Required to Complete)

Crushed Glass Media

| | | | | | | | | |
|----------|---|-------|-------|---|---|---|---|---|
| MEDIA-CP | Copper Embers - Crushed Glass Media (1 bag, 5lbs) | HTI 1 | \$ 77 | Y | Y | Y | Y | Y |
| MEDIA-CY | Crystal Embers - Crushed Glass Media (1 bag, 5lbs) | HTI 1 | \$ 77 | Y | Y | Y | Y | Y |
| MEDIA-GT | Graphite Embers - Crushed Glass Media (1 bag, 5lbs) | HTI 1 | \$ 77 | Y | Y | Y | Y | Y |
| MEDIA-SM | Smoked Embers - Crushed Glass Media (1 bag, 5lbs) | HTI 1 | \$ 77 | Y | Y | Y | Y | Y |

Stone Media

| | | | | | | | | |
|-------------|--|-------|--------|----|----|----|----|---|
| STONES-KMOD | Stone accents (must use Crushed Glass Media) | HTI 1 | \$ 319 | 21 | 14 | 14 | 14 | Y |
|-------------|--|-------|--------|----|----|----|----|---|

Gas Logs - Log Set Option

Logs

| | | | | | | | | |
|-----------|---|-------|--------|---|----|----|----|---|
| LOGS-KMOD | Driftwood Logs (must use Crushed Glass Media) | HTI 1 | \$ 529 | Y | 14 | 14 | 14 | Y |
|-----------|---|-------|--------|---|----|----|----|---|

Fans

Fan

| | | | | | | | | |
|----------|--|-------|--------|---|---|---|---|---|
| GFK-160C | Fan kit 160 CFM (fan only) | HTI 1 | \$ 259 | Y | Y | Y | Y | Y |
| GFK-160A | Fan kit 160 CFM (includes rheostat and temperature sensor) | HTI 1 | \$ 319 | Y | Y | Y | Y | Y |

Heat Management

Heat Management

| | | | | | | | | |
|--------------|--|-------|--------|---|---|---|----|---|
| PH-SIDETRIM | Passive Heat trim kit for side discharge (includes 2 side registers)(Starting collars sold separately) | HTI 1 | \$ 110 | Y | Y | Y | Y | Y |
| PH-FRTRIM-36 | Passive Heat Vent Trim Kit For Front Discharge (36")(Starting collars sold separately) | HTI 1 | \$ 209 | Y | Y | Y | 21 | Y |
| PH-MR | Passive Heat Kit starting collars (requires a side or front trim kit or use open top chase) | HTI 1 | \$ 269 | Y | Y | Y | Y | Y |

Heat Out Kit

| | | | | | | | | |
|--------------|---|-------|----------|---|----|---|----|---|
| HEAT-OUT-GAS | Heat out kit (includes termination cap, 25' of 6" round duct, fireplace adapter, damper, wall switch and 350CFM fan at termination) | HTI 1 | \$ 1,529 | Y | 14 | Y | 14 | Y |
|--------------|---|-------|----------|---|----|---|----|---|

| Heat Zone Kit | | | | | |
|---------------|--|-------|----|-----|------------|
| HZMR-ADP | Required adaptor for HEAT-ZONE-GAS when not being paired with Passive Heat | HTI 0 | \$ | 104 | Y Y Y 14 Y |
| HEAT-ZONE-GAS | Heat-Zone Kit includes fan, 20' of 6" round duct, vent, wall adapter & on/off control. Wire Plug Assembly 26D0619 required if controlling w/RC400 remote. Used in IFT units with ACM & not a GFK fan. Compatible for up to 2 HEAT-ZONE-GAS kits. See manual. | HTI 1 | \$ | 569 | Y Y Y Y Y |

Control, remotes, wall switches

Battery Back Up

| | | | | | |
|-------------|--|-------|----|-----|-------------|
| BATTERY-WSK | Battery backup wall switch kit for units with IFT control systems. Includes: On/Off Wall Switch, USB-C Port, Battery Backup, Cover Plate, 12' Wire Harness | HTI 1 | \$ | 189 | Y 14 Y 14 Y |
|-------------|--|-------|----|-----|-------------|

IntelliFire app

| | | | | | |
|---------|---|-------|----|-----|-----------|
| IFT-WFM | IntelliFire Wi-Fi Module that works with the IntelliFire iOS and Android app. Use to control all the features of your fireplace via a smart device. An RC400, RC450 or RC150 is required for thermostat control | HTI 1 | \$ | 229 | Y Y Y Y Y |
|---------|---|-------|----|-----|-----------|

IntelliFire Touch Controls - Aux Module

| | | | | | |
|---------|---|-------|----|----|-------------|
| IFT-ACM | IntelliFire Touch AUX Module. Must order if adding Fan, Lights or Power Vent and want to use the IFT-WFM. Do not need to order if using IFT-RC400 (includes IFT-ACM). | HTI 1 | \$ | 98 | Y Y 14 14 Y |
|---------|---|-------|----|----|-------------|

Touch Screen Remote

| | | | | | |
|-----------|---|-------|----|-----|-----------|
| IFT-RC400 | IntelliFire Touch black remote control, docking station and auxiliary control module (on/off, flame height, thermostat mode, fan control, child lock, cold climate, timer mode, hot indicator, lights, on-screen maintenance and troubleshooting notifications) | HTI 1 | \$ | 389 | Y Y Y Y Y |
|-----------|---|-------|----|-----|-----------|

Wall Switch

| | | | | | |
|---------------|---|-------|----|-----|-----------|
| IFT-RC150-HNG | IntelliFire Touch white wireless wall switch (on/off, cold climate, battery strength indicator) | HNG 1 | \$ | 121 | Y Y Y Y Y |
|---------------|---|-------|----|-----|-----------|



Battery Back Up



IntelliFire app

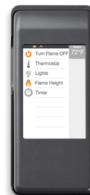

Touch Screen Remote



Wall Switch

Venting

Brick Extension Kit

| | | | | | |
|--------------|--|-------|----|----|--------------|
| HEAT-OUT-BEK | Exterior Heat-Zone brick extension kit | HTI 1 | \$ | 73 | 8 21 21 14 Y |
|--------------|--|-------|----|----|--------------|

Venting Notes

Requires 8" DVP pipe. Must have a 6" minimum vertical vent before attaching a 90 degree elbow to the fireplace. See Venting section.

Approved for use with SLP pipe. Restrictions apply. See Installation manual for venting specifications.

Approved for use with PVLP-SLP, PVI-SLP-B and PVV-SLP with power vent wire harness and IFT-RC400 remote (order separately). See venting section of manual.

6KL

Includes:

- 18,000 - 35,000 Btu/Hour Input (NG)
- 18,000 - 34,000 Btu/Hour Input (LP)
- Ceramic glass
- 6 Ceramic fiber logs
- LED Accent lighting (not used with Black glass liner)
- Battery backup
- Ceramic fiber burner top
- Glowing embers
- RC400 touchscreen remote
- IntelliFire Touch Ignition system



Required to Complete - Sold Separately: • Front

| | | Disc. Code | MSRP USD | 004 IA | 010 PA | 014 CA | 016 NC | EXP |
|-----------|---|------------|----------|--------|--------|--------|--------|-----|
| 6KL-SJ | 6KL 36" Direct Vent Gas Fireplace Top/Rear Vent with IntelliFire Touch ignition and large traditional Serene Jute refractory (NG) | HNG 1 | \$ 4,219 | Y | 14 | 14 | 14 | N |
| 6KL-LP-SJ | 6KL 36" Direct Vent Gas Fireplace Top/Rear Vent with IntelliFire Touch ignition and large traditional Serene Jute refractory (LP) | HNG 1 | \$ 4,299 | 14 | 14 | 14 | 14 | N |
| 6KL-TG | 6KL 36" Direct Vent Gas Fireplace Top/Rear Vent with IntelliFire Touch ignition and herringbone Tranquil Greige refractory (NG) | HNG 1 | \$ 4,279 | Y | 14 | 14 | 14 | N |
| 6KL-LP-TG | 6KL 36" Direct Vent Gas Fireplace Top/Rear Vent with IntelliFire Touch ignition and herringbone Tranquil Greige refractory (LP) | HNG 1 | \$ 4,349 | 14 | 14 | 14 | 14 | N |

Fronts (Required to Complete)

Folio

| | | | | | | | | |
|------------|--------------------------------|-------|--------|---|---|---|---|---|
| FOLIO-6-BK | Folio inside fit front - Black | HNG 1 | \$ 369 | Y | Y | Y | Y | Y |
|------------|--------------------------------|-------|--------|---|---|---|---|---|

Studio

| | | | | | | | | |
|-------------|-----------------------------------|-------|--------|---|----|---|----|---|
| STUDIO-6-BK | Studio overlap front - Black | HNG 1 | \$ 639 | Y | Y | Y | Y | Y |
| STUDIO-6-GM | Studio overlap front - Gun Metal | HNG 1 | \$ 689 | Y | 14 | Y | 14 | Y |
| STUDIO-6-NB | Studio overlap front - New Bronze | HNG 1 | \$ 689 | Y | 14 | Y | 14 | Y |

Portrait

| | | | | | | | | |
|---------------|--|-------|----------|---|----|----|----|---|
| PORTRAIT-6-BK | Portrait clean face overlap front - Black (note mantel or Passive Heat requirements) | HNG 1 | \$ 1,049 | Y | Y | Y | Y | Y |
| PORTRIM6-BR | Optional plated trim for Portrait front - Burnished Brass | HNG 1 | \$ 529 | Y | 14 | Y | 14 | Y |
| PORTRIM6-CO | Optional plated trim for Portrait front - Vintage Copper | HNG 1 | \$ 529 | Y | 14 | 14 | 14 | Y |
| PORTRIM6-NI | Optional plated trim for Portrait front - Satin Nickel | HNG 1 | \$ 529 | Y | 14 | 14 | 14 | Y |

Loft

| | | | | | | | | |
|-----------|--|-------|----------|---|----|----|----|---|
| LOFT-6-BK | Loft barn door overlap front with ClearVue mesh - Black | HNG 1 | \$ 1,049 | Y | Y | Y | Y | Y |
| LOFT-6-GM | Loft barn door overlap front with ClearVue mesh - Gun Metal | HNG 1 | \$ 1,099 | Y | Y | 14 | 14 | Y |
| LOFT-6-NB | Loft barn door overlap front with ClearVue mesh - New Bronze | HNG 1 | \$ 1,099 | Y | 14 | 14 | 14 | Y |

Chapel

| | | | | | | | | |
|-------------|---|-------|----------|---|----|----|----|---|
| CHAPEL-6-BK | Chapel arched overlap front with ClearVue mesh - Black | HNG 1 | \$ 1,159 | Y | Y | 14 | 14 | Y |
| CHAPEL-6-GM | Chapel arched overlap front with ClearVue mesh - Gun Metal | HNG 1 | \$ 1,209 | Y | 14 | 14 | 14 | Y |
| CHAPEL-6-NB | Chapel arched overlap front with ClearVue mesh - New Bronze | HNG 1 | \$ 1,209 | Y | 14 | Y | 14 | Y |

Forge

| | | | | | | | | |
|---------|---|-------|----------|---|---|---|---|---|
| FORGE-6 | Forge hand-crafted overlap front with ClearVue mesh | HNG 1 | \$ 2,259 | Y | Y | Y | Y | Y |
|---------|---|-------|----------|---|---|---|---|---|



Folio



Studio



Portrait



Loft



Chapel



Forge

Liner Kit

Brick Refractory

| | | | | | | | | |
|--------------|--|-------|--------|---|----|----|----|---|
| BRICK-6KL-CU | Calm Umber, 4 piece traditional brick refractory | HNG 1 | \$ 459 | Y | 14 | 14 | 14 | Y |
|--------------|--|-------|--------|---|----|----|----|---|

Liner Kit Black Glass Liner - 2 Sided

| | | | | | | | | |
|---------|---|-------|----------|---|----|----|----|---|
| GL-36MX | 4 Pc - 2-Sided Reflective Black Glass/Matte Glass Liner | HTI 1 | \$ 1,079 | Y | 14 | 14 | 14 | Y |
|---------|---|-------|----------|---|----|----|----|---|

Fans

Fan

| | | | | | | | | |
|----------|--|-------|--------|---|---|---|---|---|
| GFK-160C | Fan kit 160 CFM (fan only) | HTI 1 | \$ 259 | Y | Y | Y | Y | Y |
| GFK-160A | Fan kit 160 CFM (includes rheostat and temperature sensor) | HTI 1 | \$ 319 | Y | Y | Y | Y | Y |

Ceramic Log

Birch Logs

| | | | | | | | | |
|------------|---------------|-------|--------|---|---|----|----|---|
| LOGS-6-BIR | Birch Log set | HNG 1 | \$ 689 | Y | Y | 14 | 14 | Y |
|------------|---------------|-------|--------|---|---|----|----|---|

Heat Management

Heat Management

| | | | | | | | | |
|--------------|--|-------|--------|---|---|---|----|---|
| PH-SIDETRIM | Passive Heat trim kit for side discharge (includes 2 side registers)(Starting collars sold separately) | HTI 1 | \$ 110 | Y | Y | Y | Y | Y |
| PH-FRTRIM-36 | Passive Heat Vent Trim Kit For Front Discharge (36")(Starting collars sold separately) | HTI 1 | \$ 209 | Y | Y | Y | 21 | Y |
| PH-MR | Passive Heat Kit starting collars (requires a side or front trim kit or use open top chase) | HTI 1 | \$ 269 | Y | Y | Y | Y | Y |

Heat Out Kit

| | | | | | | | | |
|--------------|---|-------|----------|---|----|---|----|---|
| HEAT-OUT-GAS | Heat out kit (includes termination cap, 25' of 6" round duct, fireplace adapter, damper, wall switch and 350CFM fan at termination) | HTI 1 | \$ 1,529 | Y | 14 | Y | 14 | Y |
|--------------|---|-------|----------|---|----|---|----|---|

Heat Zone Kit

| | | | | | | | | |
|---------------|--|-------|--------|---|---|---|----|---|
| HZMR-ADP | Required adaptor for HEAT-ZONE-GAS when not being paired with Passive Heat | HTI 0 | \$ 104 | Y | Y | Y | 14 | Y |
| HEAT-ZONE-GAS | Heat-Zone Kit includes fan, 20' of 6" round duct, vent, wall adapter & on/off control. Wire Plug Assembly 26D0619 required if controlling w/RC400 remote. Used in IFT units with ACM & not a GFK fan. Compatible for up to 2 HEAT-ZONE-GAS kits. See manual. | HTI 1 | \$ 569 | Y | Y | Y | Y | Y |

Control, remotes, wall switches

Battery Back Up

| | | | | | | | | |
|-------------|--|-------|--------|---|----|---|----|---|
| BATTERY-WSK | Battery backup wall switch kit for units with IFT control systems. Includes: On/Off Wall Switch, USB-C Port, Battery Backup, Cover Plate, 12' Wire Harness | HTI 1 | \$ 189 | Y | 14 | Y | 14 | Y |
|-------------|--|-------|--------|---|----|---|----|---|

IntelliFire app

| | | | | | | | | |
|---------|---|-------|--------|---|---|---|---|---|
| IFT-WFM | IntelliFire Wi-Fi Module that works with the IntelliFire iOS and Android app. Use to control all the features of your fireplace via a smart device. An RC400, RC450 or RC150 is required for thermostat control | HTI 1 | \$ 229 | Y | Y | Y | Y | Y |
|---------|---|-------|--------|---|---|---|---|---|

IntelliFire Touch Controls - Aux Module

| | | | | | | | | |
|---------|---|-------|-------|---|---|----|----|---|
| IFT-ACM | IntelliFire Touch AUX Module. Must order if adding Fan, Lights or Power Vent and want to use the IFT-WFM. Do not need to order if using IFT-RC400 (includes IFT-ACM). | HTI 1 | \$ 98 | Y | Y | 14 | 14 | Y |
|---------|---|-------|-------|---|---|----|----|---|

Touch Screen Remote

| | | | | | | | | |
|-----------|---|-------|--------|---|---|---|---|---|
| IFT-RC400 | IntelliFire Touch black remote control, docking station and auxiliary control module (on/off, flame height, thermostat mode, fan control, child lock, cold climate, timer mode, hot indicator, lights, on-screen maintenance and troubleshooting notifications) | HTI 1 | \$ 389 | Y | Y | Y | Y | Y |
|-----------|---|-------|--------|---|---|---|---|---|

Wall Switch

| | | | | | | | | |
|---------------|---|-------|--------|---|---|---|---|---|
| IFT-RC150-HNG | IntelliFire Touch white wireless wall switch (on/off, cold climate, battery strength indicator) | HNG 1 | \$ 121 | Y | Y | Y | Y | Y |
|---------------|---|-------|--------|---|---|---|---|---|



Battery Back Up



IntelliFire app

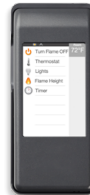

Touch Screen Remote



Wall Switch

Venting

Brick Extension Kit

| | | | | | | | | |
|--------------|--|-------|-------|---|----|----|----|---|
| HEAT-OUT-BEK | Exterior Heat-Zone brick extension kit | HTI 1 | \$ 73 | 8 | 21 | 21 | 14 | Y |
|--------------|--|-------|-------|---|----|----|----|---|

Venting Notes

Requires 8" DVP pipe.
 Approved for use with SLP pipe. Restrictions apply. See Installation manual for venting specifications.
 Approved for use with PVL-SP, PVI-SLP-B and PVV-SLP with power vent wire harness and IFT-RC400 remote (order separately). See venting section of manual.

6KX

Includes:

- 22,000 - 40,000 Btu/Hour Input (NG)
- 21,000 - 40,000 Btu/Hour Input (LP)
- Virtually invisible anti-reflective ceramic glass
- 6 premium ceramic fiber logs
- LED Accent lighting (not used with Black glass liner)
- GFK-160 variable speed fan
- LED illuminated embers
- Ceramic fiber burner top
- IntelliFire Touch Ignition System
- RC-400 Touchscreen remote control
- Battery backup



Required to Complete - Sold Separately: • Front

| | | Disc. Code | MSRP USD | 004 IA | 010 PA | 014 CA | 016 NC | EXP |
|------------|--|------------|----------|--------|--------|--------|--------|-----|
| 6KX-SJ | 6KX 36" Direct Vent Gas Fireplace Top/Rear Vent with IntelliFire Touch ignition and large traditional Serene Jute refractory (NG) | HNG 1 | \$ 5,409 | Y | Y | Y | Y | N |
| 6KX-LP-SJ | 6KX 36" Direct Vent Gas Fireplace Top/Rear Vent with IntelliFire Touch ignition and large traditional Serene Jute refractory (LP) | HNG 1 | \$ 5,479 | Y | Y | 14 | 14 | N |
| 6KX-TG | 6KX 36" Direct Vent Gas Fireplace Top/Rear Vent with IntelliFire Touch ignition and herringbone Tranquil Greige refractory (NG) | HNG 1 | \$ 5,459 | Y | Y | Y | Y | N |
| 6KX-LP-TG | 6KX 36" Direct Vent Gas Fireplace Top/Rear Vent with IntelliFire Touch ignition and herringbone Tranquil Greige refractory (LP) | HNG 1 | \$ 5,539 | Y | Y | Y | 14 | N |
| 6KX-TG-BIR | 6KX 36" Direct Vent Gas Fireplace Top/Rear Vent with IntelliFire Touch ignition and herringbone Tranquil Greige refractory and Birch Logs (NG) | HNG 1 | \$ 5,669 | Y | Y | 14 | 14 | N |
| 6KX-BL | 6KX 36" Direct Vent Gas Fireplace Top/Rear Vent with IntelliFire Touch ignition and 2-Sided Reflective Black Glass/Matte Glass Liner (NG) | HNG 1 | \$ 5,769 | Y | Y | Y | 14 | N |
| 6KX-BL-BIR | 6KX 36" Direct Vent Gas Fireplace Top/Rear Vent with IntelliFire Touch ignition and 2-Sided Reflective Black Glass/Matte Glass Liner and Birch Logs (NG) | HNG 1 | \$ 6,029 | Y | Y | Y | 14 | N |
| 6KX-CU | 6KX 36" Direct Vent Gas Fireplace Top/Rear Vent with IntelliFire Touch ignition and traditional Calm Umber refractory (NG) | HNG 1 | \$ 5,409 | Y | Y | Y | Y | N |

Fronts (Required to Complete)

Folio

| | | | | | | | | |
|------------|--------------------------------|-------|--------|---|---|---|---|---|
| FOLIO-6-BK | Folio inside fit front - Black | HNG 1 | \$ 369 | Y | Y | Y | Y | Y |
|------------|--------------------------------|-------|--------|---|---|---|---|---|

Studio

| | | | | | | | | |
|-------------|-----------------------------------|-------|--------|---|----|---|----|---|
| STUDIO-6-BK | Studio overlap front - Black | HNG 1 | \$ 639 | Y | Y | Y | Y | Y |
| STUDIO-6-GM | Studio overlap front - Gun Metal | HNG 1 | \$ 689 | Y | 14 | Y | 14 | Y |
| STUDIO-6-NB | Studio overlap front - New Bronze | HNG 1 | \$ 689 | Y | 14 | Y | 14 | Y |

Portrait

| | | | | | | | | |
|---------------|--|-------|----------|---|----|----|----|---|
| PORTRAIT-6-BK | Portrait clean face overlap front - Black (note mantel or Passive Heat requirements) | HNG 1 | \$ 1,049 | Y | Y | Y | Y | Y |
| PORTRIM6-BR | Optional plated trim for Portrait front - Burnished Brass | HNG 1 | \$ 529 | Y | 14 | Y | 14 | Y |
| PORTRIM6-CO | Optional plated trim for Portrait front - Vintage Copper | HNG 1 | \$ 529 | Y | 14 | 14 | 14 | Y |
| PORTRIM6-NI | Optional plated trim for Portrait front - Satin Nickel | HNG 1 | \$ 529 | Y | 14 | 14 | 14 | Y |

Loft

| | | | | | | | | |
|-----------|--|-------|----------|---|----|----|----|---|
| LOFT-6-BK | Loft barn door overlap front with ClearVue mesh - Black | HNG 1 | \$ 1,049 | Y | Y | Y | Y | Y |
| LOFT-6-GM | Loft barn door overlap front with ClearVue mesh - Gun Metal | HNG 1 | \$ 1,099 | Y | Y | 14 | 14 | Y |
| LOFT-6-NB | Loft barn door overlap front with ClearVue mesh - New Bronze | HNG 1 | \$ 1,099 | Y | 14 | 14 | 14 | Y |

| Chapel | | | | | | | | | |
|-------------|---|-------|----------|---|----|----|----|---|--|
| CHAPEL-6-BK | Chapel arched overlap front with ClearVue mesh - Black | HNG 1 | \$ 1,159 | Y | Y | 14 | 14 | Y | |
| CHAPEL-6-GM | Chapel arched overlap front with ClearVue mesh - Gun Metal | HNG 1 | \$ 1,209 | Y | 14 | 14 | 14 | Y | |
| CHAPEL-6-NB | Chapel arched overlap front with ClearVue mesh - New Bronze | HNG 1 | \$ 1,209 | Y | 14 | Y | 14 | Y | |

| Forge | | | | | | | | | |
|---------|---|-------|----------|---|---|---|---|---|--|
| FORGE-6 | Forge hand-crafted overlap front with ClearVue mesh | HNG 1 | \$ 2,259 | Y | Y | Y | Y | Y | |



Folio



Studio

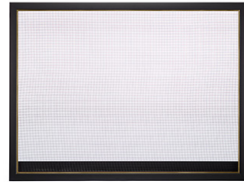

Portrait



Loft



Chapel



Forge

| LP Conversion Kit | | | | | | | | | |
|-------------------|-------------------|-------|-------|---|---|---|---|---|--|
| LPK-MID | LP Conversion kit | HTI 1 | \$ 99 | Y | Y | Y | Y | Y | |

| Fans | | | | | | | | | |
|----------|--|-------|--------|---|---|---|---|---|--|
| GFK-160C | Fan kit 160 CFM (fan only) | HTI 1 | \$ 259 | Y | Y | Y | Y | Y | |
| GFK-160A | Fan kit 160 CFM (includes rheostat and temperature sensor) | HTI 1 | \$ 319 | Y | Y | Y | Y | Y | |

| Ceramic Log | | | | | | | | | |
|-------------|---------------|-------|--------|---|---|----|----|---|--|
| LOGS-6-BIR | Birch Log set | HNG 1 | \$ 689 | Y | Y | 14 | 14 | Y | |

| Heat Management | | | | | | | | | |
|-----------------|--|-------|--------|---|---|---|----|---|--|
| PH-SIDETRIM | Passive Heat trim kit for side discharge (includes 2 side registers)(Starting collars sold separately) | HTI 1 | \$ 110 | Y | Y | Y | Y | Y | |
| PH-FRTRIM-36 | Passive Heat Vent Trim Kit For Front Discharge (36")(Starting collars sold separately) | HTI 1 | \$ 209 | Y | Y | Y | 21 | Y | |
| PH-MR | Passive Heat Kit starting collars (requires a side or front trim kit or use open top chase) | HTI 1 | \$ 269 | Y | Y | Y | Y | Y | |

| Heat Out Kit | | | | | | | | | |
|--------------|---|-------|----------|---|----|---|----|---|--|
| HEAT-OUT-GAS | Heat out kit (includes termination cap, 25' of 6" round duct, fireplace adapter, damper, wall switch and 350CFM fan at termination) | HTI 1 | \$ 1,529 | Y | 14 | Y | 14 | Y | |

| Heat Zone Kit | | | | | |
|---------------|--|-------|----|-----|------------|
| HZMR-ADP | Required adaptor for HEAT-ZONE-GAS when not being paired with Passive Heat | HTI 0 | \$ | 104 | Y Y Y 14 Y |
| HEAT-ZONE-GAS | Heat-Zone Kit includes fan, 20' of 6" round duct, vent, wall adapter & on/off control. Wire Plug Assembly 26D0619 required if controlling w/RC400 remote. Used in IFT units with ACM & not a GFK fan. Compatible for up to 2 HEAT-ZONE-GAS kits. See manual. | HTI 1 | \$ | 569 | Y Y Y Y Y |

Control, remotes, wall switches

Battery Back Up

| | | | | | |
|-------------|--|-------|----|-----|-------------|
| BATTERY-WSK | Battery backup wall switch kit for units with IFT control systems. Includes: On/Off Wall Switch, USB-C Port, Battery Backup, Cover Plate, 12' Wire Harness | HTI 1 | \$ | 189 | Y 14 Y 14 Y |
|-------------|--|-------|----|-----|-------------|

IntelliFire app

| | | | | | |
|---------|---|-------|----|-----|-----------|
| IFT-WFM | IntelliFire Wi-Fi Module that works with the IntelliFire iOS and Android app. Use to control all the features of your fireplace via a smart device. An RC400, RC450 or RC150 is required for thermostat control | HTI 1 | \$ | 229 | Y Y Y Y Y |
|---------|---|-------|----|-----|-----------|

IntelliFire Touch Controls - Aux Module

| | | | | | |
|---------|---|-------|----|----|-------------|
| IFT-ACM | IntelliFire Touch AUX Module. Must order if adding Fan, Lights or Power Vent and want to use the IFT-WFM. Do not need to order if using IFT-RC400 (includes IFT-ACM). | HTI 1 | \$ | 98 | Y Y 14 14 Y |
|---------|---|-------|----|----|-------------|

Touch Screen Remote

| | | | | | |
|-----------|---|-------|----|-----|-----------|
| IFT-RC400 | IntelliFire Touch black remote control, docking station and auxiliary control module (on/off, flame height, thermostat mode, fan control, child lock, cold climate, timer mode, hot indicator, lights, on-screen maintenance and troubleshooting notifications) | HTI 1 | \$ | 389 | Y Y Y Y Y |
|-----------|---|-------|----|-----|-----------|

Wall Switch

| | | | | | |
|---------------|---|-------|----|-----|-----------|
| IFT-RC150-HNG | IntelliFire Touch white wireless wall switch (on/off, cold climate, battery strength indicator) | HNG 1 | \$ | 121 | Y Y Y Y Y |
|---------------|---|-------|----|-----|-----------|



Battery Back Up



IntelliFire app

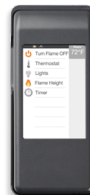

Touch Screen Remote



Wall Switch

Venting

Brick Extension Kit

| | | | | | |
|--------------|--|-------|----|----|--------------|
| HEAT-OUT-BEK | Exterior Heat-Zone brick extension kit | HTI 1 | \$ | 73 | 8 21 21 14 Y |
|--------------|--|-------|----|----|--------------|

Venting Notes

Requires 8" DVP pipe.
 Approved for use with SLP pipe. Restrictions apply. See Installation manual for venting specifications.
 Approved for use with PVLP-SLP, PVI-SLP-B and PVV-SLP with power vent wire harness (order separately) and IFT-RC400 remote. See venting section of manual.

8K

Includes:

- 19,000 - 35,000 Btu/Hour Input (NG) • IntelliFire Touch Ignition System
- 17,000 - 34,000 Btu/Hour Input (LP)
- 12 ft Wall switch wire
- Tempered glass
- 6 ceramic fiber logs
- Glowing embers
- Ceramic fiber burner top
- Battery backup



Special Considerations:

- Flame adjustment requires RC400 or IFT-WFM

Required to Complete - Sold Separately: • Front

| | | Disc. Code | MSRP USD | 004 IA | 010 PA | 014 CA | 016 NC | EXP |
|-------|---|------------|----------|--------|--------|--------|--------|-----|
| 8K | 8K 42" Direct Vent Gas Fireplace Top/Rear Vent with IntelliFire Touch ignition (NG) | HNG 1 | \$ 4,009 | Y | Y | Y | Y | N |
| 8K-LP | 8K 42" Direct Vent Gas Fireplace Top/Rear Vent with IntelliFire Touch ignition (LP) | HNG 1 | \$ 4,079 | 14 | 14 | 14 | Y | N |

Fronts (Required to Complete)

Folio

| | | | | | | | | |
|------------|--------------------------------|-------|--------|---|---|---|---|---|
| FOLIO-8-BK | Folio inside fit front - Black | HNG 1 | \$ 429 | Y | Y | Y | Y | Y |
|------------|--------------------------------|-------|--------|---|---|---|---|---|

Studio

| | | | | | | | | |
|-------------|-----------------------------------|-------|--------|----|----|----|----|---|
| STUDIO-8-BK | Studio overlap front - Black | HNG 1 | \$ 739 | Y | Y | Y | Y | Y |
| STUDIO-8-GM | Studio overlap front - Gun Metal | HNG 1 | \$ 789 | 14 | 14 | 14 | 14 | Y |
| STUDIO-8-NB | Studio overlap front - New Bronze | HNG 1 | \$ 789 | 14 | 14 | 14 | 14 | Y |

Portrait

| | | | | | | | | |
|---------------|--|-------|----------|---|----|----|----|---|
| PORTRAIT-8-BK | Portrait clean face overlap front - Black (note mantel or Passive Heat requirements) | HNG 1 | \$ 1,159 | Y | Y | Y | Y | Y |
| PORTRIM8-BR | Optional plated trim for Portrait front - Burnished Brass | HNG 1 | \$ 579 | Y | 14 | 14 | 14 | Y |
| PORTRIM8-CO | Optional plated trim for Portrait front - Vintage Copper | HNG 1 | \$ 579 | Y | 14 | 14 | 14 | Y |
| PORTRIM8-NI | Optional plated trim for Portrait front - Satin Nickel | HNG 1 | \$ 579 | Y | 14 | 14 | 14 | Y |

Loft

| | | | | | | | | |
|-----------|--|-------|----------|----|----|----|----|---|
| LOFT-8-BK | Loft barn door overlap front with ClearVue mesh - Black | HNG 1 | \$ 1,159 | Y | Y | Y | Y | Y |
| LOFT-8-GM | Loft barn door overlap front with ClearVue mesh - Gun Metal | HNG 1 | \$ 1,209 | Y | 14 | 14 | 14 | Y |
| LOFT-8-NB | Loft barn door overlap front with ClearVue mesh - New Bronze | HNG 1 | \$ 1,209 | 14 | 14 | 14 | 14 | Y |

Chapel

| | | | | | | | | |
|-------------|---|-------|----------|----|----|----|----|---|
| CHAPEL-8-BK | Chapel arched overlap front with ClearVue mesh - Black | HNG 1 | \$ 1,259 | Y | Y | Y | 14 | Y |
| CHAPEL-8-GM | Chapel arched overlap front with ClearVue mesh - Gun Metal | HNG 1 | \$ 1,309 | 14 | 14 | 14 | 14 | Y |
| CHAPEL-8-NB | Chapel arched overlap front with ClearVue mesh - New Bronze | HNG 1 | \$ 1,309 | 14 | 14 | 14 | 14 | Y |

Forge

| | | | | | | | | |
|---------|---|-------|----------|---|---|---|---|---|
| FORGE-8 | Forge hand-crafted overlap front with ClearVue mesh | HNG 1 | \$ 2,459 | Y | Y | Y | Y | Y |
|---------|---|-------|----------|---|---|---|---|---|



Folio



Studio



Portrait



Loft



Chapel



Forge

Liner Kit

Brick Refractory

| | | | | | | | | | |
|-------------|---|-------|--------|---|----|----|----|----|---|
| BRICK-8K-TG | Tranquil Greige, 3 piece herringbone brick refractory | HNG 1 | \$ 449 | Y | 14 | 14 | 14 | 14 | Y |
| BRICK-8K-SJ | Serene Jute, 3 piece large traditional brick refractory | HNG 1 | \$ 479 | Y | 28 | 28 | 28 | 28 | Y |
| BRICK-8K-CU | Calm Umber, 3 piece traditional brick refractory | HNG 1 | \$ 479 | Y | 14 | 14 | 14 | 14 | Y |

Liner Kit Black Glass Liner - 2 Sided

| | | | | | | | | | |
|--------|---|-------|----------|----|----|----|----|----|---|
| GL-42M | 3 Pc - 2-Sided Reflective Black Glass/Matte Glass Liner | HTI 1 | \$ 1,079 | 14 | 14 | 14 | 14 | 14 | Y |
|--------|---|-------|----------|----|----|----|----|----|---|

Fans

Fan

| | | | | | | | | | |
|----------|--|-------|--------|---|---|---|---|---|---|
| GFK-160C | Fan kit 160 CFM (fan only) | HTI 1 | \$ 259 | Y | Y | Y | Y | Y | Y |
| GFK-160A | Fan kit 160 CFM (includes rheostat and temperature sensor) | HTI 1 | \$ 319 | Y | Y | Y | Y | Y | Y |

Ceramic Log

Birch Logs

| | | | | | | | | | |
|------------|---------------|-------|--------|---|----|----|----|----|---|
| LOGS-8-BIR | Birch Log set | HNG 1 | \$ 789 | Y | 14 | 14 | 14 | 14 | Y |
|------------|---------------|-------|--------|---|----|----|----|----|---|

Heat Management

Heat Management

| | | | | | | | | | |
|--------------|--|-------|--------|---|---|---|---|---|---|
| PH-SIDETRIM | Passive Heat trim kit for side discharge (includes 2 side registers)(Starting collars sold separately) | HTI 1 | \$ 110 | Y | Y | Y | Y | Y | Y |
| PH-FRTRIM-42 | Passive Heat Vent Trim Kit For Front Discharge (42")(Starting collars sold separately) | HTI 1 | \$ 209 | Y | Y | Y | Y | Y | Y |
| PH-MR | Passive Heat Kit starting collars (requires a side or front trim kit or use open top chase) | HTI 1 | \$ 269 | Y | Y | Y | Y | Y | Y |

Heat Out Kit

| | | | | | | | | | |
|--------------|---|-------|----------|---|----|---|----|---|---|
| HEAT-OUT-GAS | Heat out kit (includes termination cap, 25' of 6" round duct, fireplace adapter, damper, wall switch and 350CFM fan at termination) | HTI 1 | \$ 1,529 | Y | 14 | Y | 14 | Y | Y |
|--------------|---|-------|----------|---|----|---|----|---|---|

| Heat Zone Kit | | | | | | | | |
|---------------|--|-------|--------|---|---|---|----|---|
| HZMR-ADP | Required adaptor for HEAT-ZONE-GAS when not being paired with Passive Heat | HTI 0 | \$ 104 | Y | Y | Y | 14 | Y |
| HEAT-ZONE-GAS | Heat-Zone Kit includes fan, 20' of 6" round duct, vent, wall adapter & on/off control. Wire Plug Assembly 26D0619 required if controlling w/RC400 remote. Used in IFT units with ACM & not a GFK fan. Compatible for up to 2 HEAT-ZONE-GAS kits. See manual. | HTI 1 | \$ 569 | Y | Y | Y | Y | Y |

Control, remotes, wall switches

Battery Back Up

| | | | | | | | | |
|-------------|--|-------|--------|---|----|---|----|---|
| BATTERY-WSK | Battery backup wall switch kit for units with IFT control systems. Includes: On/Off Wall Switch, USB-C Port, Battery Backup, Cover Plate, 12' Wire Harness | HTI 1 | \$ 189 | Y | 14 | Y | 14 | Y |
|-------------|--|-------|--------|---|----|---|----|---|

IntelliFire app

| | | | | | | | | |
|---------|---|-------|--------|---|---|---|---|---|
| IFT-WFM | IntelliFire Wi-Fi Module that works with the IntelliFire iOS and Android app. Use to control all the features of your fireplace via a smart device. An RC400, RC450 or RC150 is required for thermostat control | HTI 1 | \$ 229 | Y | Y | Y | Y | Y |
|---------|---|-------|--------|---|---|---|---|---|

IntelliFire Touch Controls - Aux Module

| | | | | | | | | |
|---------|---|-------|-------|---|---|----|----|---|
| IFT-ACM | IntelliFire Touch AUX Module. Must order if adding Fan, Lights or Power Vent and want to use the IFT-WFM. Do not need to order if using IFT-RC400 (includes IFT-ACM). | HTI 1 | \$ 98 | Y | Y | 14 | 14 | Y |
|---------|---|-------|-------|---|---|----|----|---|

Touch Screen Remote

| | | | | | | | | |
|-----------|---|-------|--------|---|---|---|---|---|
| IFT-RC400 | IntelliFire Touch black remote control, docking station and auxiliary control module (on/off, flame height, thermostat mode, fan control, child lock, cold climate, timer mode, hot indicator, lights, on-screen maintenance and troubleshooting notifications) | HTI 1 | \$ 389 | Y | Y | Y | Y | Y |
|-----------|---|-------|--------|---|---|---|---|---|

Wall Switch

| | | | | | | | | |
|---------------|---|-------|--------|---|---|---|---|---|
| IFT-RC150-HNG | IntelliFire Touch white wireless wall switch (on/off, cold climate, battery strength indicator) | HNG 1 | \$ 121 | Y | Y | Y | Y | Y |
|---------------|---|-------|--------|---|---|---|---|---|



Battery Back Up



IntelliFire app

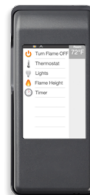

Touch Screen Remote



Wall Switch

Venting

Brick Extension Kit

| | | | | | | | | |
|--------------|--|-------|-------|---|----|----|----|---|
| HEAT-OUT-BEK | Exterior Heat-Zone brick extension kit | HTI 1 | \$ 73 | 8 | 21 | 21 | 14 | Y |
|--------------|--|-------|-------|---|----|----|----|---|

Venting Notes

Requires 8" DVP pipe.
 Approved for use with SLP pipe. Restrictions apply. See Installation manual for venting specifications.
 Approved for use with PVL-PSLP, PVI-SLP-B and PVV-SLP with power vent wire harness and IFT-RC400 remote (order separately). See venting section of manual.

8K Modern

Includes:

- 18,000 - 36,000 Btu/Hour Input (NG)
- IntelliFire Touch Ignition System
- Virtually invisible anti-reflective ceramic glass
- 2 sided black ceramic glass liner
- 12 ft wall switch wire
- Battery Backup



Special Considerations:

- Flame adjustment requires RC400 or IFT-WFM
- LP is not available for this fireplace

Required to Complete - Sold Separately: • Front

• Crushed Glass Media (Qty 3)

| | | Disc. Code | MSRP USD | 004 IA | 010 PA | 014 CA | 016 NC | EXP |
|-------|--|------------|----------|--------|--------|--------|--------|-----|
| 8KMOD | 8K Modern 42" Direct Vent Gas Fireplace top vent (NG) - 2-Sided Reflective Black Glass/Matte Glass Liner | HNG 1 | \$ 4,839 | Y | 14 | 14 | 14 | N |

Fronts (Required to Complete)

Folio

| | | | | | | | | |
|------------|--------------------------------|-------|--------|---|---|---|---|---|
| FOLIO-8-BK | Folio inside fit front - Black | HNG 1 | \$ 429 | Y | Y | Y | Y | Y |
|------------|--------------------------------|-------|--------|---|---|---|---|---|

Studio

| | | | | | | | | |
|-------------|-----------------------------------|-------|--------|----|----|----|----|---|
| STUDIO-8-BK | Studio overlap front - Black | HNG 1 | \$ 739 | Y | Y | Y | Y | Y |
| STUDIO-8-NB | Studio overlap front - New Bronze | HNG 1 | \$ 789 | 14 | 14 | 14 | 14 | Y |
| STUDIO-8-GM | Studio overlap front - Gun Metal | HNG 1 | \$ 789 | 14 | 14 | 14 | 14 | Y |

Portrait

| | | | | | | | | |
|---------------|--|-------|----------|---|----|----|----|---|
| PORTRAIT-8-BK | Portrait clean face overlap front - Black (note mantel or Passive Heat requirements) | HNG 1 | \$ 1,159 | Y | Y | Y | Y | Y |
| PORTRIM8-BR | Optional plated trim for Portrait front - Burnished Brass | HNG 1 | \$ 579 | Y | 14 | 14 | 14 | Y |
| PORTRIM8-CO | Optional plated trim for Portrait front - Vintage Copper | HNG 1 | \$ 579 | Y | 14 | 14 | 14 | Y |
| PORTRIM8-NI | Optional plated trim for Portrait front - Satin Nickel | HNG 1 | \$ 579 | Y | 14 | 14 | 14 | Y |

Loft

| | | | | | | | | |
|-----------|--|-------|----------|----|----|----|----|---|
| LOFT-8-BK | Loft barn door overlap front with ClearVue mesh - Black | HNG 1 | \$ 1,159 | Y | Y | Y | Y | Y |
| LOFT-8-GM | Loft barn door overlap front with ClearVue mesh - Gun Metal | HNG 1 | \$ 1,209 | Y | 14 | 14 | 14 | Y |
| LOFT-8-NB | Loft barn door overlap front with ClearVue mesh - New Bronze | HNG 1 | \$ 1,209 | 14 | 14 | 14 | 14 | Y |

Chapel

| | | | | | | | | |
|-------------|---|-------|----------|----|----|----|----|---|
| CHAPEL-8-BK | Chapel arched overlap front with ClearVue mesh - Black | HNG 1 | \$ 1,259 | Y | Y | Y | 14 | Y |
| CHAPEL-8-GM | Chapel arched overlap front with ClearVue mesh - Gun Metal | HNG 1 | \$ 1,309 | 14 | 14 | 14 | 14 | Y |
| CHAPEL-8-NB | Chapel arched overlap front with ClearVue mesh - New Bronze | HNG 1 | \$ 1,309 | 14 | 14 | 14 | 14 | Y |

Forge

| | | | | | | | | |
|---------|---|-------|----------|---|---|---|---|---|
| FORGE-8 | Forge hand-crafted overlap front with ClearVue mesh | HNG 1 | \$ 2,459 | Y | Y | Y | Y | Y |
|---------|---|-------|----------|---|---|---|---|---|



Folio



Studio



Portrait



Loft



Chapel



Forge

Media (Required to Complete)

Crushed Glass Media

| | | | | | | | | |
|----------|---|-------|-------|---|---|---|---|---|
| MEDIA-CP | Copper Embers - Crushed Glass Media (1 bag, 5lbs) | HTI 1 | \$ 77 | Y | Y | Y | Y | Y |
| MEDIA-CY | Crystal Embers - Crushed Glass Media (1 bag, 5lbs) | HTI 1 | \$ 77 | Y | Y | Y | Y | Y |
| MEDIA-GT | Graphite Embers - Crushed Glass Media (1 bag, 5lbs) | HTI 1 | \$ 77 | Y | Y | Y | Y | Y |
| MEDIA-SM | Smoked Embers - Crushed Glass Media (1 bag, 5lbs) | HTI 1 | \$ 77 | Y | Y | Y | Y | Y |

Stone Media

| | | | | | | | | |
|-------------|--|-------|--------|----|----|----|----|---|
| STONES-KMOD | Stone accents (must use Crushed Glass Media) | HTI 1 | \$ 319 | 21 | 14 | 14 | 14 | Y |
|-------------|--|-------|--------|----|----|----|----|---|

Gas Logs - Log Set Option

Logs

| | | | | | | | | |
|-----------|---|-------|--------|---|----|----|----|---|
| LOGS-KMOD | Driftwood Logs (must use Crushed Glass Media) | HTI 1 | \$ 529 | Y | 14 | 14 | 14 | Y |
|-----------|---|-------|--------|---|----|----|----|---|

Fans

Fan

| | | | | | | | | |
|----------|--|-------|--------|---|---|---|---|---|
| GFK-160C | Fan kit 160 CFM (fan only) | HTI 1 | \$ 259 | Y | Y | Y | Y | Y |
| GFK-160A | Fan kit 160 CFM (includes rheostat and temperature sensor) | HTI 1 | \$ 319 | Y | Y | Y | Y | Y |

Heat Management

Heat Management

| | | | | | | | | |
|--------------|--|-------|--------|---|---|---|---|---|
| PH-SIDETRIM | Passive Heat trim kit for side discharge (includes 2 side registers)(Starting collars sold separately) | HTI 1 | \$ 110 | Y | Y | Y | Y | Y |
| PH-FRTRIM-42 | Passive Heat Vent Trim Kit For Front Discharge (42")(Starting collars sold separately) | HTI 1 | \$ 209 | Y | Y | Y | Y | Y |
| PH-MR | Passive Heat Kit starting collars (requires a side or front trim kit or use open top chase) | HTI 1 | \$ 269 | Y | Y | Y | Y | Y |

Heat Out Kit

| | | | | | | | | |
|--------------|---|-------|----------|---|----|---|----|---|
| HEAT-OUT-GAS | Heat out kit (includes termination cap, 25' of 6" round duct, fireplace adapter, damper, wall switch and 350CFM fan at termination) | HTI 1 | \$ 1,529 | Y | 14 | Y | 14 | Y |
|--------------|---|-------|----------|---|----|---|----|---|

| Heat Zone Kit | | | | | |
|---------------|--|-------|----|-----|------------|
| HZMR-ADP | Required adaptor for HEAT-ZONE-GAS when not being paired with Passive Heat | HTI 0 | \$ | 104 | Y Y Y 14 Y |
| HEAT-ZONE-GAS | Heat-Zone Kit includes fan, 20' of 6" round duct, vent, wall adapter & on/off control. Wire Plug Assembly 26D0619 required if controlling w/RC400 remote. Used in IFT units with ACM & not a GFK fan. Compatible for up to 2 HEAT-ZONE-GAS kits. See manual. | HTI 1 | \$ | 569 | Y Y Y Y Y |

Control, remotes, wall switches

Battery Back Up

| | | | | | |
|-------------|--|-------|----|-----|-------------|
| BATTERY-WSK | Battery backup wall switch kit for units with IFT control systems. Includes: On/Off Wall Switch, USB-C Port, Battery Backup, Cover Plate, 12' Wire Harness | HTI 1 | \$ | 189 | Y 14 Y 14 Y |
|-------------|--|-------|----|-----|-------------|

IntelliFire app

| | | | | | |
|---------|---|-------|----|-----|-----------|
| IFT-WFM | IntelliFire Wi-Fi Module that works with the IntelliFire iOS and Android app. Use to control all the features of your fireplace via a smart device. An RC400, RC450 or RC150 is required for thermostat control | HTI 1 | \$ | 229 | Y Y Y Y Y |
|---------|---|-------|----|-----|-----------|

IntelliFire Touch Controls - Aux Module

| | | | | | |
|---------|---|-------|----|----|-------------|
| IFT-ACM | IntelliFire Touch AUX Module. Must order if adding Fan, Lights or Power Vent and want to use the IFT-WFM. Do not need to order if using IFT-RC400 (includes IFT-ACM). | HTI 1 | \$ | 98 | Y Y 14 14 Y |
|---------|---|-------|----|----|-------------|

Touch Screen Remote

| | | | | | |
|-----------|---|-------|----|-----|-----------|
| IFT-RC400 | IntelliFire Touch black remote control, docking station and auxiliary control module (on/off, flame height, thermostat mode, fan control, child lock, cold climate, timer mode, hot indicator, lights, on-screen maintenance and troubleshooting notifications) | HTI 1 | \$ | 389 | Y Y Y Y Y |
|-----------|---|-------|----|-----|-----------|

Wall Switch

| | | | | | |
|---------------|---|-------|----|-----|-----------|
| IFT-RC150-HNG | IntelliFire Touch white wireless wall switch (on/off, cold climate, battery strength indicator) | HNG 1 | \$ | 121 | Y Y Y Y Y |
|---------------|---|-------|----|-----|-----------|



Battery Back Up



IntelliFire app

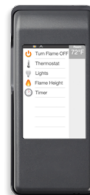

Touch Screen Remote



Wall Switch

Venting

Brick Extension Kit

| | | | | | |
|--------------|--|-------|----|----|--------------|
| HEAT-OUT-BEK | Exterior Heat-Zone brick extension kit | HTI 1 | \$ | 73 | 8 21 21 14 Y |
|--------------|--|-------|----|----|--------------|

Venting Notes

Requires 8" DVP pipe. Must have a 6" minimum vertical vent before attaching a 90 degree elbow to the fireplace. See Venting section.

Approved for use with SLP pipe. Restrictions apply. See Installation manual for venting specifications.

Approved for use with PVLP-SLP, PVI-SLP-B and PVV-SLP with power vent wire harness (order separately) and IFT-RC400 remote. See venting section of manual.

8KL

Includes:

- 20,000 - 40,000 Btu/Hour Input (NG)
- 22,000 - 40,000 Btu/Hour Input (LP)
- Ceramic glass
- 6 Ceramic fiber logs
- LED Accent lighting (not used with Black glass liner)
- Glowing embers
- Ceramic fiber burner top
- Battery backup
- RC400 touchscreen remote
- IntelliFire Touch Ignition system



Required to Complete - Sold Separately: • Front

| | | Disc. Code | MSRP USD | 004 IA | 010 PA | 014 CA | 016 NC | EXP |
|-----------|---|------------|----------|--------|--------|--------|--------|-----|
| 8KL-SJ | 8KL 42" Direct Vent Gas Fireplace Top/Rear Vent with IntelliFire Touch ignition and large traditional Serene Jute refractory (NG) | HNG 1 | \$ 5,099 | 14 | Y | 14 | 14 | N |
| 8KL-LP-SJ | 8KL 42" Direct Vent Gas Fireplace Top/Rear Vent with IntelliFire Touch ignition and large traditional Serene Jute refractory (LP) | HNG 1 | \$ 5,169 | 14 | 14 | 14 | 14 | N |
| 8KL-TG | 8KL 42" Direct Vent Gas Fireplace Top/Rear Vent with IntelliFire Touch ignition and herringbone Tranquil Greige refractory (NG) | HNG 1 | \$ 5,149 | 14 | 14 | 14 | 14 | N |
| 8KL-LP-TG | 8KL 42" Direct Vent Gas Fireplace Top/Rear Vent with IntelliFire Touch ignition and herringbone Tranquil Greige refractory (LP) | HNG 1 | \$ 5,219 | 14 | 14 | 14 | 14 | N |

Fronts (Required to Complete)

Folio

| | | | | | | | | |
|------------|--------------------------------|-------|--------|---|---|---|---|---|
| FOLIO-8-BK | Folio inside fit front - Black | HNG 1 | \$ 429 | Y | Y | Y | Y | Y |
|------------|--------------------------------|-------|--------|---|---|---|---|---|

Studio

| | | | | | | | | |
|-------------|-----------------------------------|-------|--------|----|----|----|----|---|
| STUDIO-8-BK | Studio overlap front - Black | HNG 1 | \$ 739 | Y | Y | Y | Y | Y |
| STUDIO-8-NB | Studio overlap front - New Bronze | HNG 1 | \$ 789 | 14 | 14 | 14 | 14 | Y |
| STUDIO-8-GM | Studio overlap front - Gun Metal | HNG 1 | \$ 789 | 14 | 14 | 14 | 14 | Y |

Portrait

| | | | | | | | | |
|---------------|--|-------|----------|---|----|----|----|---|
| PORTRAIT-8-BK | Portrait clean face overlap front - Black (note mantel or Passive Heat requirements) | HNG 1 | \$ 1,159 | Y | Y | Y | Y | Y |
| PORTRIM8-BR | Optional plated trim for Portrait front - Burnished Brass | HNG 1 | \$ 579 | Y | 14 | 14 | 14 | Y |
| PORTRIM8-CO | Optional plated trim for Portrait front - Vintage Copper | HNG 1 | \$ 579 | Y | 14 | 14 | 14 | Y |
| PORTRIM8-NI | Optional plated trim for Portrait front - Satin Nickel | HNG 1 | \$ 579 | Y | 14 | 14 | 14 | Y |

Loft

| | | | | | | | | |
|-----------|--|-------|----------|----|----|----|----|---|
| LOFT-8-BK | Loft barn door overlap front with ClearVue mesh - Black | HNG 1 | \$ 1,159 | Y | Y | Y | Y | Y |
| LOFT-8-GM | Loft barn door overlap front with ClearVue mesh - Gun Metal | HNG 1 | \$ 1,209 | Y | 14 | 14 | 14 | Y |
| LOFT-8-NB | Loft barn door overlap front with ClearVue mesh - New Bronze | HNG 1 | \$ 1,209 | 14 | 14 | 14 | 14 | Y |

Chapel

| | | | | | | | | |
|-------------|---|-------|----------|----|----|----|----|---|
| CHAPEL-8-BK | Chapel arched overlap front with ClearVue mesh - Black | HNG 1 | \$ 1,259 | Y | Y | Y | 14 | Y |
| CHAPEL-8-GM | Chapel arched overlap front with ClearVue mesh - Gun Metal | HNG 1 | \$ 1,309 | 14 | 14 | 14 | 14 | Y |
| CHAPEL-8-NB | Chapel arched overlap front with ClearVue mesh - New Bronze | HNG 1 | \$ 1,309 | 14 | 14 | 14 | 14 | Y |

Forge

| | | | | | | | | |
|---------|---|-------|----------|---|---|---|---|---|
| FORGE-8 | Forge hand-crafted overlap front with ClearVue mesh | HNG 1 | \$ 2,459 | Y | Y | Y | Y | Y |
|---------|---|-------|----------|---|---|---|---|---|



Folio



Studio



Portrait



Loft



Chapel



Forge

Liner Kit

Brick Refractory

| | | | | | | | | | |
|--------------|--|-------|--------|---|----|----|----|----|---|
| BRICK-8KL-CU | Calm Umber, 4 piece traditional brick refractory | HNG 1 | \$ 579 | Y | 14 | 14 | 14 | 14 | Y |
|--------------|--|-------|--------|---|----|----|----|----|---|

Liner Kit Black Glass Liner - 2 Sided

| | | | | | | | | | |
|---------|---|-------|----------|----|----|----|----|----|---|
| GL-42MX | 4 Pc - 2-Sided Reflective Black Glass/Matte Glass Liner | HTI 1 | \$ 1,289 | 14 | 14 | 14 | 14 | 14 | Y |
|---------|---|-------|----------|----|----|----|----|----|---|

Fans

Fan

| | | | | | | | | | |
|----------|--|-------|--------|---|---|---|---|---|---|
| GFK-160C | Fan kit 160 CFM (fan only) | HTI 1 | \$ 259 | Y | Y | Y | Y | Y | Y |
| GFK-160A | Fan kit 160 CFM (includes rheostat and temperature sensor) | HTI 1 | \$ 319 | Y | Y | Y | Y | Y | Y |

Ceramic Log

Birch Logs

| | | | | | | | | | |
|------------|---------------|-------|--------|---|----|----|----|----|---|
| LOGS-8-BIR | Birch Log set | HNG 1 | \$ 789 | Y | 14 | 14 | 14 | 14 | Y |
|------------|---------------|-------|--------|---|----|----|----|----|---|

Heat Management

Heat Management

| | | | | | | | | | |
|--------------|--|-------|--------|---|---|---|---|---|---|
| PH-SIDETRIM | Passive Heat trim kit for side discharge (includes 2 side registers)(Starting collars sold separately) | HTI 1 | \$ 110 | Y | Y | Y | Y | Y | Y |
| PH-FRTRIM-42 | Passive Heat Vent Trim Kit For Front Discharge (42")(Starting collars sold separately) | HTI 1 | \$ 209 | Y | Y | Y | Y | Y | Y |
| PH-MR | Passive Heat Kit starting collars (requires a side or front trim kit or use open top chase) | HTI 1 | \$ 269 | Y | Y | Y | Y | Y | Y |

Heat Out Kit

| | | | | | | | | | |
|--------------|---|-------|----------|---|----|---|----|---|---|
| HEAT-OUT-GAS | Heat out kit (includes termination cap, 25' of 6" round duct, fireplace adapter, damper, wall switch and 350CFM fan at termination) | HTI 1 | \$ 1,529 | Y | 14 | Y | 14 | Y | Y |
|--------------|---|-------|----------|---|----|---|----|---|---|

Heat Zone Kit

| | | | | | | | | | |
|---------------|--|-------|--------|---|---|---|----|---|---|
| HZMR-ADP | Required adaptor for HEAT-ZONE-GAS when not being paired with Passive Heat | HTI 0 | \$ 104 | Y | Y | Y | 14 | Y | Y |
| HEAT-ZONE-GAS | Heat-Zone Kit includes fan, 20' of 6" round duct, vent, wall adapter & on/off control. Wire Plug Assembly 26D0619 required if controlling w/RC400 remote. Used in IFT units with ACM & not a GFK fan. Compatible for up to 2 HEAT-ZONE-GAS kits. See manual. | HTI 1 | \$ 569 | Y | Y | Y | Y | Y | Y |

Control, remotes, wall switches

Battery Back Up

| | | | | | | | | |
|-------------|--|-------|--------|---|----|---|----|---|
| BATTERY-WSK | Battery backup wall switch kit for units with IFT control systems. Includes: On/Off Wall Switch, USB-C Port, Battery Backup, Cover Plate, 12' Wire Harness | HTI 1 | \$ 189 | Y | 14 | Y | 14 | Y |
|-------------|--|-------|--------|---|----|---|----|---|

IntelliFire app

| | | | | | | | | |
|---------|---|-------|--------|---|---|---|---|---|
| IFT-WFM | IntelliFire Wi-Fi Module that works with the IntelliFire iOS and Android app. Use to control all the features of your fireplace via a smart device. An RC400, RC450 or RC150 is required for thermostat control | HTI 1 | \$ 229 | Y | Y | Y | Y | Y |
|---------|---|-------|--------|---|---|---|---|---|

IntelliFire Touch Controls - Aux Module

| | | | | | | | | |
|---------|---|-------|-------|---|---|----|----|---|
| IFT-ACM | IntelliFire Touch AUX Module. Must order if adding Fan, Lights or Power Vent and want to use the IFT-WFM. Do not need to order if using IFT-RC400 (includes IFT-ACM). | HTI 1 | \$ 98 | Y | Y | 14 | 14 | Y |
|---------|---|-------|-------|---|---|----|----|---|

Touch Screen Remote

| | | | | | | | | |
|-----------|---|-------|--------|---|---|---|---|---|
| IFT-RC400 | IntelliFire Touch black remote control, docking station and auxiliary control module (on/off, flame height, thermostat mode, fan control, child lock, cold climate, timer mode, hot indicator, lights, on-screen maintenance and troubleshooting notifications) | HTI 1 | \$ 389 | Y | Y | Y | Y | Y |
|-----------|---|-------|--------|---|---|---|---|---|

Wall Switch

| | | | | | | | | |
|---------------|---|-------|--------|---|---|---|---|---|
| IFT-RC150-HNG | IntelliFire Touch white wireless wall switch (on/off, cold climate, battery strength indicator) | HNG 1 | \$ 121 | Y | Y | Y | Y | Y |
|---------------|---|-------|--------|---|---|---|---|---|



Battery Back Up



IntelliFire app

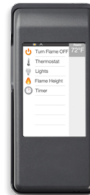

Touch Screen Remote



Wall Switch

Venting

Brick Extension Kit

| | | | | | | | | |
|--------------|--|-------|-------|---|----|----|----|---|
| HEAT-OUT-BEK | Exterior Heat-Zone brick extension kit | HTI 1 | \$ 73 | 8 | 21 | 21 | 14 | Y |
|--------------|--|-------|-------|---|----|----|----|---|

Venting Notes

Requires 8" DVP pipe.
 Approved for use with SLP pipe. Restrictions apply. See Installation manual for venting specifications.
 Approved for use with PVLP-SLP, PVI-SLP-B and PVV-SLP with power vent wire harness (order separately) and IFT-RC400 remote. See venting section of manual.

8KX

Includes:

- 23,000 - 45,000 Btu/Hour Input (NG)
- 23,000 - 44,000 Btu/Hour Input (LP)
- Virtually invisible anti-reflective ceramic glass
- 6 premium ceramic fiber logs
- LED Accent lighting (not used with Black glass liner)
- GFK-160 variable speed fan
- Battery backup
- LED illuminated embers
- 4 piece liner/refractory
- Ceramic fiber burner top
- IntelliFire Touch Ignition System
- RC-400 Touchscreen remote control



Required to Complete - Sold Separately: • Front

| | | Disc. Code | MSRP USD | 004 IA | 010 PA | 014 CA | 016 NC | EXP |
|------------|--|------------|----------|--------|--------|--------|--------|-----|
| 8KX-SJ | 8KX 42" Direct Vent Gas Fireplace Top/Rear Vent with IntelliFire Touch ignition and large traditional Serene Jute refractory (NG) | HNG 1 | \$ 6,259 | Y | Y | Y | 14 | N |
| 8KX-LP-SJ | 8KX 42" Direct Vent Gas Fireplace Top/Rear Vent with IntelliFire Touch ignition and large traditional Serene Jute refractory (LP) | HNG 1 | \$ 6,339 | 14 | 14 | Y | Y | N |
| 8KX-TG | 8KX 42" Direct Vent Gas Fireplace Top/Rear Vent with IntelliFire Touch ignition and herringbone Tranquil Greige refractory (NG) | HNG 1 | \$ 6,319 | Y | Y | Y | Y | N |
| 8KX-LP-TG | 8KX 42" Direct Vent Gas Fireplace Top/Rear Vent with IntelliFire Touch ignition and herringbone Tranquil Greige refractory (LP) | HNG 1 | \$ 6,389 | Y | Y | Y | Y | N |
| 8KX-TG-BIR | 8KX 42" Direct Vent Gas Fireplace Top/Rear Vent with IntelliFire Touch ignition and herringbone Tranquil Greige refractory and Birch Logs (NG) | HNG 1 | \$ 6,579 | Y | Y | 14 | 14 | N |
| 8KX-BL | 8KX 42" Direct Vent Gas Fireplace Top/Rear Vent with IntelliFire Touch ignition and 2-Sided Reflective Black Glass/Matte Glass Liner(NG) | HNG 1 | \$ 6,589 | Y | Y | Y | 14 | N |
| 8KX-BL-BIR | 8KX 42" Direct Vent Gas Fireplace Top/Rear Vent with IntelliFire Touch ignition and 2-Sided Reflective Black Glass/Matte Glass Liner and Birch Logs (NG) | HNG 1 | \$ 6,839 | Y | Y | 14 | 14 | N |
| 8KX-CU | 8KX 42" Direct Vent Gas Fireplace Top/Rear Vent with IntelliFire Touch ignition and traditional Calm Umber refractory (NG) | HNG 1 | \$ 6,259 | Y | Y | Y | Y | N |

Fronts (Required to Complete)

Folio

| | | | | | | | | |
|------------|--------------------------------|-------|--------|---|---|---|---|---|
| FOLIO-8-BK | Folio inside fit front - Black | HNG 1 | \$ 429 | Y | Y | Y | Y | Y |
|------------|--------------------------------|-------|--------|---|---|---|---|---|

Studio

| | | | | | | | | |
|-------------|-----------------------------------|-------|--------|----|----|----|----|---|
| STUDIO-8-BK | Studio overlap front - Black | HNG 1 | \$ 739 | Y | Y | Y | Y | Y |
| STUDIO-8-GM | Studio overlap front - Gun Metal | HNG 1 | \$ 789 | 14 | 14 | 14 | 14 | Y |
| STUDIO-8-NB | Studio overlap front - New Bronze | HNG 1 | \$ 789 | 14 | 14 | 14 | 14 | Y |

Portrait

| | | | | | | | | |
|---------------|--|-------|----------|---|----|----|----|---|
| PORTRAIT-8-BK | Portrait clean face overlap front - Black (note mantel or Passive Heat requirements) | HNG 1 | \$ 1,159 | Y | Y | Y | Y | Y |
| PORTRIM8-BR | Optional plated trim for Portrait front - Burnished Brass | HNG 1 | \$ 579 | Y | 14 | 14 | 14 | Y |
| PORTRIM8-CO | Optional plated trim for Portrait front - Vintage Copper | HNG 1 | \$ 579 | Y | 14 | 14 | 14 | Y |
| PORTRIM8-NI | Optional plated trim for Portrait front - Satin Nickel | HNG 1 | \$ 579 | Y | 14 | 14 | 14 | Y |

Loft

| | | | | | | | | |
|-----------|--|-------|----------|----|----|----|----|---|
| LOFT-8-BK | Loft barn door overlap front with ClearVue mesh - Black | HNG 1 | \$ 1,159 | Y | Y | Y | Y | Y |
| LOFT-8-GM | Loft barn door overlap front with ClearVue mesh - Gun Metal | HNG 1 | \$ 1,209 | Y | 14 | 14 | 14 | Y |
| LOFT-8-NB | Loft barn door overlap front with ClearVue mesh - New Bronze | HNG 1 | \$ 1,209 | 14 | 14 | 14 | 14 | Y |

| Chapel | | | | | | | | | |
|-------------|---|-------|----------|----|----|----|----|---|--|
| CHAPEL-8-BK | Chapel arched overlap front with ClearVue mesh - Black | HNG 1 | \$ 1,259 | Y | Y | Y | 14 | Y | |
| CHAPEL-8-GM | Chapel arched overlap front with ClearVue mesh - Gun Metal | HNG 1 | \$ 1,309 | 14 | 14 | 14 | 14 | Y | |
| CHAPEL-8-NB | Chapel arched overlap front with ClearVue mesh - New Bronze | HNG 1 | \$ 1,309 | 14 | 14 | 14 | 14 | Y | |

| Forge | | | | | | | | | |
|---------|---|-------|----------|---|---|---|---|---|--|
| FORGE-8 | Forge hand-crafted overlap front with ClearVue mesh | HNG 1 | \$ 2,459 | Y | Y | Y | Y | Y | |



Folio

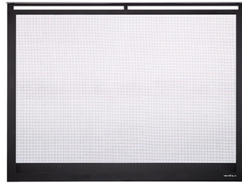

Studio

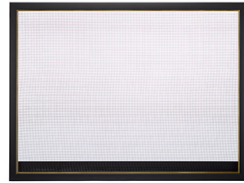

Portrait



Loft



Chapel



Forge

| LP Conversion Kit | | | | | | | | | |
|-------------------|-------------------|-------|-------|---|---|---|---|---|--|
| LPK-MID | LP Conversion kit | HTI 1 | \$ 99 | Y | Y | Y | Y | Y | |

| Fans | | | | | | | | | |
|----------|--|-------|--------|---|---|---|---|---|--|
| GFK-160C | Fan kit 160 CFM (fan only) | HTI 1 | \$ 259 | Y | Y | Y | Y | Y | |
| GFK-160A | Fan kit 160 CFM (includes rheostat and temperature sensor) | HTI 1 | \$ 319 | Y | Y | Y | Y | Y | |

| Ceramic Log | | | | | | | | | |
|-------------|---------------|-------|--------|---|----|----|----|---|--|
| LOGS-8-BIR | Birch Log set | HNG 1 | \$ 789 | Y | 14 | 14 | 14 | Y | |

| Heat Management | | | | | | | | | |
|-----------------|--|-------|--------|---|---|---|---|---|--|
| PH-SIDETRIM | Passive Heat trim kit for side discharge (includes 2 side registers)(Starting collars sold separately) | HTI 1 | \$ 110 | Y | Y | Y | Y | Y | |
| PH-FRTRIM-42 | Passive Heat Vent Trim Kit For Front Discharge (42")(Starting collars sold separately) | HTI 1 | \$ 209 | Y | Y | Y | Y | Y | |
| PH-MR | Passive Heat Kit starting collars (requires a side or front trim kit or use open top chase) | HTI 1 | \$ 269 | Y | Y | Y | Y | Y | |

| Heat Out Kit | | | | | | | | | |
|--------------|---|-------|----------|---|----|---|----|---|--|
| HEAT-OUT-GAS | Heat out kit (includes termination cap, 25' of 6" round duct, fireplace adapter, damper, wall switch and 350CFM fan at termination) | HTI 1 | \$ 1,529 | Y | 14 | Y | 14 | Y | |

| Heat Zone Kit | | | | | | | | |
|---------------|--|-------|--------|---|---|---|----|---|
| HZMR-ADP | Required adaptor for HEAT-ZONE-GAS when not being paired with Passive Heat | HTI 0 | \$ 104 | Y | Y | Y | 14 | Y |
| HEAT-ZONE-GAS | Heat-Zone Kit includes fan, 20' of 6" round duct, vent, wall adapter & on/off control. Wire Plug Assembly 26D0619 required if controlling w/RC400 remote. Used in IFT units with ACM & not a GFK fan. Compatible for up to 2 HEAT-ZONE-GAS kits. See manual. | HTI 1 | \$ 569 | Y | Y | Y | Y | Y |

Control, remotes, wall switches

Battery Back Up

| | | | | | | | | |
|-------------|--|-------|--------|---|----|---|----|---|
| BATTERY-WSK | Battery backup wall switch kit for units with IFT control systems. Includes: On/Off Wall Switch, USB-C Port, Battery Backup, Cover Plate, 12' Wire Harness | HTI 1 | \$ 189 | Y | 14 | Y | 14 | Y |
|-------------|--|-------|--------|---|----|---|----|---|

IntelliFire app

| | | | | | | | | |
|---------|---|-------|--------|---|---|---|---|---|
| IFT-WFM | IntelliFire Wi-Fi Module that works with the IntelliFire iOS and Android app. Use to control all the features of your fireplace via a smart device. An RC400, RC450 or RC150 is required for thermostat control | HTI 1 | \$ 229 | Y | Y | Y | Y | Y |
|---------|---|-------|--------|---|---|---|---|---|

IntelliFire Touch Controls - Aux Module

| | | | | | | | | |
|---------|---|-------|-------|---|---|----|----|---|
| IFT-ACM | IntelliFire Touch AUX Module. Must order if adding Fan, Lights or Power Vent and want to use the IFT-WFM. Do not need to order if using IFT-RC400 (includes IFT-ACM). | HTI 1 | \$ 98 | Y | Y | 14 | 14 | Y |
|---------|---|-------|-------|---|---|----|----|---|

Touch Screen Remote

| | | | | | | | | |
|-----------|---|-------|--------|---|---|---|---|---|
| IFT-RC400 | IntelliFire Touch black remote control, docking station and auxiliary control module (on/off, flame height, thermostat mode, fan control, child lock, cold climate, timer mode, hot indicator, lights, on-screen maintenance and troubleshooting notifications) | HTI 1 | \$ 389 | Y | Y | Y | Y | Y |
|-----------|---|-------|--------|---|---|---|---|---|

Wall Switch

| | | | | | | | | |
|---------------|---|-------|--------|---|---|---|---|---|
| IFT-RC150-HNG | IntelliFire Touch white wireless wall switch (on/off, cold climate, battery strength indicator) | HNG 1 | \$ 121 | Y | Y | Y | Y | Y |
|---------------|---|-------|--------|---|---|---|---|---|



Battery Back Up



IntelliFire app

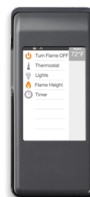

Touch Screen Remote



Wall Switch

Venting

Brick Extension Kit

| | | | | | | | | |
|--------------|--|-------|-------|---|----|----|----|---|
| HEAT-OUT-BEK | Exterior Heat-Zone brick extension kit | HTI 1 | \$ 73 | 8 | 21 | 21 | 14 | Y |
|--------------|--|-------|-------|---|----|----|----|---|

Venting Notes

Requires 8" DVP pipe.
 Approved for use with SLP pipe. Restrictions apply. See Installation manual for venting specifications.
 Approved for use with PVL-PSLP, PVI-SLP-B and PVV-SLP with power vent wire harness and IFT-RC400 remote (order separately). See venting section of manual.

Cerona 36 36" Direct Vent Gas Fireplace

Includes:

- 25,000 - 37,500 Btu/Hour Input (NG)
- Traditional FireBrick firebox with Tranquil Greige brick
- IntelliFire Touch Ignition System
- Virtually invisible anti-reflective glass
- RC400 Touchscreen remote control
- Variable speed fan
- LED accent lighting
- Battery backup
- 6 ceramic fiber logs
- Non-combustible board
- Front Finishing Template



Required to Complete - Sold Separately: • Front

| | | Disc. Code | MSRP USD | 004 IA | 010 PA | 014 CA | 016 NC | EXP |
|---------------|---|------------|----------|--------|--------|--------|--------|-----|
| CERONA-36-IFT | Cerona 36" Direct Vent Gas Fireplace top vent arched fireplace with IntelliFire Touch ignition and Tranquil Greige brick (NG) | HNG 2 | \$ 5,709 | Y | 14 | 14 | 14 | N |

Fronts - Non-Operable (Required to Complete)

Chateau Forge

| | | | | | | | | |
|----------|----------------------------------|-------|----------|----|----|----|----|---|
| CHAF-C36 | Chateau Forge hand-crafted front | HNG 2 | \$ 2,359 | 14 | 14 | 14 | 14 | Y |
|----------|----------------------------------|-------|----------|----|----|----|----|---|

Firescreen

| | | | | | | | | |
|-----------|-------------------------------|-------|--------|----|----|----|----|---|
| FS-C36-BK | Firescreen front - Black | HNG 2 | \$ 759 | Y | Y | 14 | 14 | Y |
| FS-C36-GM | Firescreen front - Gun Metal | HNG 1 | \$ 799 | 14 | 14 | 14 | 14 | Y |
| FS-C36-NB | Firescreen front - New Bronze | HNG 2 | \$ 799 | 14 | 14 | 14 | 14 | Y |

Iron Age

| | | | | | | | | |
|-----------|-----------------------------|-------|----------|----|----|----|----|---|
| IA-C36-BK | Iron Age front - Black | HNG 2 | \$ 979 | 14 | 14 | 14 | 14 | Y |
| IA-C36-GM | Iron Age front - Gun Metal | HNG 2 | \$ 1,039 | 14 | 14 | 14 | 14 | Y |
| IA-C36-NB | Iron Age front - New Bronze | HNG 2 | \$ 1,039 | 14 | 14 | 14 | 14 | Y |

Conversion Kit

Conversion Kit

| | | | | | | | | |
|-----------------|--|-------|-------|----|----|----|----|---|
| LPK-CERONA36IFT | LP conversion kit for the Cerona 36 IFT | HNG 1 | \$ 99 | Y | Y | Y | Y | Y |
| NGK-CERONA36IFT | Natural Gas conversion kit for the Cerona 36 IFT | HNG 1 | \$ 99 | 14 | 14 | 14 | 14 | Y |

Fans

Fan

| | | | | | | | | |
|----------|--|-------|--------|---|---|---|---|---|
| GFK-160C | Fan kit 160 CFM (fan only) | HTI 1 | \$ 259 | Y | Y | Y | Y | Y |
| GFK-160A | Fan kit 160 CFM (includes rheostat and temperature sensor) | HTI 1 | \$ 319 | Y | Y | Y | Y | Y |

Heat Management

Heat Management

| | | | | | | | | |
|--------------|--|-------|--------|----|----|----|----|---|
| PH-SIDETRIM | Passive Heat trim kit for side discharge (includes 2 side registers)(Starting collars sold separately) | HTI 1 | \$ 110 | Y | Y | Y | Y | Y |
| PH-CERONA | Passive Heat kit for Cerona (includes 2 starting collars and 4 passive heat templates) | HNG 2 | \$ 179 | 14 | 14 | 14 | 14 | Y |
| PH-FRTRIM-36 | Passive Heat Vent Trim Kit For Front Discharge (36")(Starting collars sold separately) | HTI 1 | \$ 209 | Y | Y | Y | 21 | Y |

| Heat Out Kit | | | | | | | | | |
|---------------------------------|---|-------|----------|---|----|---|----|---|--|
| HEAT-OUT-GAS | Heat out kit (includes termination cap, 25' of 6" round duct, fireplace adapter, damper, wall switch and 350CFM fan at termination) | HTI 1 | \$ 1,529 | Y | 14 | Y | 14 | Y | |
| Heat Zone Kit | | | | | | | | | |
| HEAT-ZONE-GAS | Heat-Zone Kit includes fan, 20' of 6" round duct, vent, wall adapter & on/off control. Wire Plug Assembly 26D0619 required if controlling w/RC400 remote. Used in IFT units with ACM & not a GFK fan. Compatible for up to 2 HEAT-ZONE-GAS kits. See manual. | HTI 1 | \$ 569 | Y | Y | Y | Y | Y | |
| Control, remotes, wall switches | | | | | | | | | |
| Battery Back Up | | | | | | | | | |
| BATTERY-WSK | Battery backup wall switch kit for units with IFT control systems. Includes: On/Off Wall Switch, USB-C Port, Battery Backup, Cover Plate, 12' Wire Harness | HTI 1 | \$ 189 | Y | 14 | Y | 14 | Y | |
| IntelliFire app | | | | | | | | | |
| IFT-WFM | IntelliFire Wi-Fi Module that works with the IntelliFire iOS and Android app. Use to control all the features of your fireplace via a smart device. An RC400, RC450 or RC150 is required for thermostat control | HTI 1 | \$ 229 | Y | Y | Y | Y | Y | |
| Touch Screen Remote | | | | | | | | | |
| IFT-RC400 | IntelliFire Touch black remote control, docking station and auxiliary control module (on/off, flame height, thermostat mode, fan control, child lock, cold climate, timer mode, hot indicator, lights, on-screen maintenance and troubleshooting notifications) | HTI 1 | \$ 389 | Y | Y | Y | Y | Y | |
| Wall Switch | | | | | | | | | |
| IFT-RC150-HNG | IntelliFire Touch white wireless wall switch (on/off, cold climate, battery strength indicator) | HNG 1 | \$ 121 | Y | Y | Y | Y | Y | |



Battery Back Up



IntelliFire app

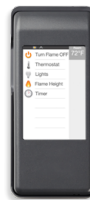

Touch Screen Remote



Wall Switch

Venting

Brick Extension Kit

| | | | | | | | | | |
|--------------|--|-------|-------|---|----|----|----|---|--|
| HEAT-OUT-BEK | Exterior Heat-Zone brick extension kit | HTI 1 | \$ 73 | 8 | 21 | 21 | 14 | Y | |
|--------------|--|-------|-------|---|----|----|----|---|--|

Venting Notes

CERONA-36 Requires 8" DVP pipe. Must have a 12" minimum vertical vent before attaching a 90° elbow to unit. See Venting section.

Approved for use with PVL P-SLP, PVI-SLP-B and PVV-SLP with power vent wire harness (order separately). See venting section of manual.

Cerona 42 42" Direct Vent Gas Fireplace

Includes:

- 32,000 - 48,000 Btu/Hour Input (NG)
- Traditional FireBrick firebox with Tranquil Greige brick
- IntelliFire Touch Ignition System
- RC400 Touchscreen remote control
- Virtually invisible anti-reflective glass
- Variable speed fan
- LED accent lighting
- Battery backup
- 6 ceramic fiber logs
- Non-combustible board
- Front Finishing Template



Required to Complete - Sold Separately: • Front

| | | Disc. Code | MSRP USD | 004 IA | 010 PA | 014 CA | 016 NC | EXP |
|---------------|---|------------|----------|--------|--------|--------|--------|-----|
| CERONA-42-IFT | Cerona 42" Direct Vent Gas Fireplace top vent arched fireplace with IntelliFire Touch ignition and Tranquil Greige brick (NG) | HNG 2 | \$ 6,349 | Y | Y | Y | Y | N |

Fronts - Non-Operable (Required to Complete)

Chateau Forge

| | | | | | | | | |
|----------|----------------------------------|-------|----------|---|----|----|----|---|
| CHAF-C42 | Chateau Forge hand-crafted front | HNG 2 | \$ 2,469 | Y | 14 | 14 | 14 | Y |
|----------|----------------------------------|-------|----------|---|----|----|----|---|

Firescreen

| | | | | | | | | |
|-----------|-------------------------------|-------|--------|----|----|----|----|---|
| FS-C42-BK | Firescreen front - Black | HNG 2 | \$ 859 | Y | Y | Y | Y | Y |
| FS-C42-NB | Firescreen front - New Bronze | HNG 2 | \$ 919 | 14 | 14 | 14 | 14 | Y |
| FS-C42-GM | Firescreen front - Gun Metal | HNG 1 | \$ 919 | 14 | 14 | 14 | 14 | Y |

Iron Age

| | | | | | | | | |
|-----------|-----------------------------|-------|----------|----|----|----|----|---|
| IA-C42-BK | Iron Age front - Black | HNG 2 | \$ 1,239 | 14 | 14 | 14 | 14 | Y |
| IA-C42-GM | Iron Age front - Gun Metal | HNG 2 | \$ 1,289 | 14 | 14 | 14 | 14 | Y |
| IA-C42-NB | Iron Age front - New Bronze | HNG 2 | \$ 1,289 | 14 | 14 | 14 | 14 | Y |

Conversion Kit

Conversion Kit

| | | | | | | | | |
|-----------------|--|-------|-------|----|----|----|----|---|
| NGK-CERONA42IFT | Natural Gas conversion kit for the Cerona 42 IFT | HNG 1 | \$ 99 | 14 | 14 | 14 | 14 | Y |
| LPK-CERONA42IFT | LP conversion kit for the Cerona 42 IFT | HNG 1 | \$ 99 | Y | Y | Y | Y | Y |

Fans

Fan

| | | | | | | | | |
|----------|--|-------|--------|---|---|---|---|---|
| GFK-160C | Fan kit 160 CFM (fan only) | HTI 1 | \$ 259 | Y | Y | Y | Y | Y |
| GFK-160A | Fan kit 160 CFM (includes rheostat and temperature sensor) | HTI 1 | \$ 319 | Y | Y | Y | Y | Y |

Heat Management

Heat Management

| | | | | | | | | |
|--------------|--|-------|--------|----|----|----|----|---|
| PH-SIDETRIM | Passive Heat trim kit for side discharge (includes 2 side registers)(Starting collars sold separately) | HTI 1 | \$ 110 | Y | Y | Y | Y | Y |
| PH-CERONA | Passive Heat kit for Cerona (includes 2 starting collars and 4 passive heat templates) | HNG 2 | \$ 179 | 14 | 14 | 14 | 14 | Y |
| PH-FRTRIM-42 | Passive Heat Vent Trim Kit For Front Discharge (42")(Starting collars sold separately) | HTI 1 | \$ 209 | Y | Y | Y | Y | Y |

| Heat Out Kit | | | | | | | | | |
|---------------------------------|---|-------|----------|---|----|---|----|---|--|
| HEAT-OUT-GAS | Heat out kit (includes termination cap, 25' of 6" round duct, fireplace adapter, damper, wall switch and 350CFM fan at termination) | HTI 1 | \$ 1,529 | Y | 14 | Y | 14 | Y | |
| Heat Zone Kit | | | | | | | | | |
| HEAT-ZONE-GAS | Heat-Zone Kit includes fan, 20' of 6" round duct, vent, wall adapter & on/off control. Wire Plug Assembly 26D0619 required if controlling w/RC400 remote. Used in IFT units with ACM & not a GFK fan. Compatible for up to 2 HEAT-ZONE-GAS kits. See manual. | HTI 1 | \$ 569 | Y | Y | Y | Y | Y | |
| Control, remotes, wall switches | | | | | | | | | |
| Battery Back Up | | | | | | | | | |
| BATTERY-WSK | Battery backup wall switch kit for units with IFT control systems. Includes: On/Off Wall Switch, USB-C Port, Battery Backup, Cover Plate, 12' Wire Harness | HTI 1 | \$ 189 | Y | 14 | Y | 14 | Y | |
| IntelliFire app | | | | | | | | | |
| IFT-WFM | IntelliFire Wi-Fi Module that works with the IntelliFire iOS and Android app. Use to control all the features of your fireplace via a smart device. An RC400, RC450 or RC150 is required for thermostat control | HTI 1 | \$ 229 | Y | Y | Y | Y | Y | |
| Touch Screen Remote | | | | | | | | | |
| IFT-RC400 | IntelliFire Touch black remote control, docking station and auxiliary control module (on/off, flame height, thermostat mode, fan control, child lock, cold climate, timer mode, hot indicator, lights, on-screen maintenance and troubleshooting notifications) | HTI 1 | \$ 389 | Y | Y | Y | Y | Y | |
| Wall Switch | | | | | | | | | |
| IFT-RC150-HNG | IntelliFire Touch white wireless wall switch (on/off, cold climate, battery strength indicator) | HNG 1 | \$ 121 | Y | Y | Y | Y | Y | |



Battery Back Up



IntelliFire app

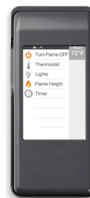

Touch Screen Remote



Wall Switch

Venting

Brick Extension Kit

| | | | | | | | | | |
|--------------|--|-------|-------|---|----|----|----|---|--|
| HEAT-OUT-BEK | Exterior Heat-Zone brick extension kit | HTI 1 | \$ 73 | 8 | 21 | 21 | 14 | Y | |
|--------------|--|-------|-------|---|----|----|----|---|--|

Venting Notes

CERONA-42 Requires 8" DVP pipe. Must have a 12" minimum vertical vent before attaching a 90° elbow to unit. See Venting section.

Approved for use with PVL P-SLP, PVI-SLP-B and PVV-SLP with power vent wire harness (order separately). See venting section of manual.

COSMO 32

Includes:

- 13,250 - 19,000 Btu/Hour Input (NG)
- 12,750 - 16,500 Btu/Hour Input (LP)
- IntelliFire Touch ignition system
- Black glass media
- Gas flex connector
- Tempered glass
- Junction box
- Battery backup
- Manual gas shut-off valve
- 4" x 6-5/8" top vent collar



Special Considerations:

- If ordering lights or fan, MUST order IFT-RC400
- If installing Passive Heat Kit you CANNOT use a fan
- Glass media CANNOT be used with traditional log set

Required to Complete - Sold Separately: • Front

| | | Disc. Code | MSRP USD | 004 IA | 010 PA | 014 CA | 016 NC | EXP |
|---------------|---|---------------|-------------|-----------|-----------|-----------|-----------|-----|
| COSMO32-IFT-B | COSMO 32" direct vent gas fireplace with IntelliFire Touch ignition system (NG) | HNG 1 | \$ 2,719 | Y | 14 | Y | 14 | N |

Fronts - Non-Operable (Required to Complete)

Clean Face Trim

| | | | | | | | | |
|------------|------------------------------|-------|--------|----|----|----|----|---|
| CFTF-32-BK | Clean Face Trim - Black | HTI 1 | \$ 439 | Y | Y | Y | 14 | Y |
| CFTF-32-GM | Clean Face Trim - Gun Metal | HTI 1 | \$ 509 | 14 | 14 | 14 | 14 | Y |
| CFTF-32-NB | Clean Face Trim - New Bronze | HTI 1 | \$ 509 | 14 | 14 | 14 | 14 | Y |

Martini

| | | | | | | | | |
|----------------|----------------------------|-------|--------|----|----|----|----|---|
| MAR-COSMO32-NB | Martini front - New Bronze | HNG 1 | \$ 749 | 14 | 14 | 14 | 14 | Y |
| MAR-COSMO32-GM | Martini front - Gun Metal | HNG 1 | \$ 749 | 14 | 14 | 14 | 14 | Y |



Clean Face Trim



Martini

Conversion Kit

Conversion Kit

| | | | | | | | | |
|--------------|-------------------|-------|-------|---|---|---|---|---|
| LPK-32LINEAR | LP conversion kit | HTI 1 | \$ 99 | Y | Y | Y | Y | Y |
|--------------|-------------------|-------|-------|---|---|---|---|---|

Gas Logs - Log Set Option

Driftwood Log Set

| | | | | | | | | |
|---------------|-------------------|-------|--------|----|----|----|----|---|
| DRIFTWOOD-C32 | Driftwood log set | HNG 1 | \$ 359 | 21 | 14 | 14 | 14 | Y |
|---------------|-------------------|-------|--------|----|----|----|----|---|

Traditional Log Set

| | | | | | | | | |
|--------------|---|-------|--------|----|----|----|----|---|
| LOGS-COSMO32 | Traditional log set (includes new burner) | HNG 1 | \$ 309 | 14 | 21 | 21 | 14 | Y |
|--------------|---|-------|--------|----|----|----|----|---|

| Media | | | | | | | | | |
|---------------------------------|--|-------|----|-------|----|----|----|----|---|
| Crushed Glass Media | | | | | | | | | |
| MEDIA-AMBER | Glass media, Amber | HTI 1 | \$ | 123 | Y | 14 | Y | 14 | Y |
| MEDIA-COBALT | Glass media, Cobalt Blue | HTI 1 | \$ | 123 | Y | 14 | 14 | 14 | Y |
| MEDIA-CRYSTAL | Glass media, Crystal (translucent white) | HTI 1 | \$ | 123 | Y | Y | Y | Y | Y |
| Glass Bead Media | | | | | | | | | |
| MEDIA-CL2-GEMS | Glass beads - Clear | HTI 1 | \$ | 189 | 14 | 21 | 14 | 14 | Y |
| MEDIA-WH2-GEMS | Glass beads - White | HTI 1 | \$ | 189 | 14 | 21 | 14 | 14 | Y |
| MEDIA-BK2-GEMS | Glass beads, Black | HTI 1 | \$ | 189 | Y | 21 | Y | 14 | Y |
| MEDIA | | | | | | | | | |
| STONES-C32 | River Rock Stone Set (Cannot be used with glass media) | HNG 1 | \$ | 309 | 21 | 14 | 14 | 14 | Y |
| Lighting | | | | | | | | | |
| LED Accent Light | | | | | | | | | |
| LED-LINEAR | LED accent lights (must order LED-SWITCH for multi-color selection) | HTI 1 | \$ | 379 | Y | Y | Y | Y | Y |
| Refractory | | | | | | | | | |
| Glass Refractory | | | | | | | | | |
| GLASS-32LINEAR | Fade-resistant reflective black glass interior panels | HTI 1 | \$ | 589 | 14 | 21 | 14 | 14 | Y |
| Fans | | | | | | | | | |
| Fan | | | | | | | | | |
| GFK-160C | Fan kit 160 CFM (fan only) | HTI 1 | \$ | 259 | Y | Y | Y | Y | Y |
| Heat Management | | | | | | | | | |
| Heat Management | | | | | | | | | |
| PH-SIDETRIM | Passive Heat trim kit for side discharge (includes 2 side registers)(Starting collars sold separately) | HTI 1 | \$ | 110 | Y | Y | Y | Y | Y |
| PH-FRTRIM-32 | Passive Heat Vent Trim Kit For Front Discharge (32")(Starting collars sold separately) | HTI 1 | \$ | 149 | 14 | 14 | 14 | 14 | Y |
| PH-LINEAR | Starting Collars for Non-Ducted Passive Heat (Required when using passive heat - For use with Front, Side, Top Discharges) | HTI 1 | \$ | 199 | Y | Y | Y | Y | Y |
| Heat Out Kit | | | | | | | | | |
| HEAT-OUT-GAS | Heat out kit (includes termination cap, 25' of 6" round duct, fireplace adapter, damper, wall switch and 350CFM fan at termination) | HTI 1 | \$ | 1,529 | Y | 14 | Y | 14 | Y |
| Heat Zone Kit | | | | | | | | | |
| HEAT-ZONE-GAS | Heat-Zone Kit includes fan, 20' of 6" round duct, vent, wall adapter & on/off control. Wire Plug Assembly 26D0619 required if controlling w/RC400 remote. Used in IFT units with ACM & not a GFK fan. Compatible for up to 2 HEAT-ZONE-GAS kits. See manual. | HTI 1 | \$ | 569 | Y | Y | Y | Y | Y |
| Control, remotes, wall switches | | | | | | | | | |
| Battery Back Up | | | | | | | | | |
| BATTERY-WSK | Battery backup wall switch kit for units with IFT control systems. Includes: On/Off Wall Switch, USB-C Port, Battery Backup, Cover Plate, 12' Wire Harness | HTI 1 | \$ | 189 | Y | 14 | Y | 14 | Y |

| IntelliFire app | | | | | | | | |
|---|---|-------|--------|---|---|----|----|---|
| IFT-WFM | IntelliFire Wi-Fi Module that works with the IntelliFire iOS and Android app. Use to control all the features of your fireplace via a smart device. An RC400, RC450 or RC150 is required for thermostat control | HTI 1 | \$ 229 | Y | Y | Y | Y | Y |
| IntelliFire Touch Controls - Aux Module | | | | | | | | |
| IFT-ACM | IntelliFire Touch AUX Module. Must order if adding Fan, Lights or Power Vent and want to use the IFT-WFM. Do not need to order if using IFT-RC400 (includes IFT-ACM). | HTI 1 | \$ 98 | Y | Y | 14 | 14 | Y |
| Remote/Wall Switch/Wall Thermostat | | | | | | | | |
| LED-SWITCH | 3 toggle wall switch for multi-color selection | HTI 1 | \$ 141 | Y | Y | 14 | 14 | Y |
| Touch Screen Remote | | | | | | | | |
| IFT-RC400 | IntelliFire Touch black remote control, docking station and auxiliary control module (on/off, flame height, thermostat mode, fan control, child lock, cold climate, timer mode, hot indicator, lights, on-screen maintenance and troubleshooting notifications) | HTI 1 | \$ 389 | Y | Y | Y | Y | Y |
| Wall Switch | | | | | | | | |
| IFT-RC150-HNG | IntelliFire Touch white wireless wall switch (on/off, cold climate, battery strength indicator) | HNG 1 | \$ 121 | Y | Y | Y | Y | Y |



Battery Back Up



IntelliFire app

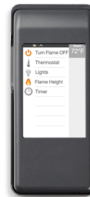

Touch Screen Remote



Wall Switch

| Venting | | | | | | | | |
|---------------------|--|-------|-------|---|----|----|----|---|
| Brick Extension Kit | | | | | | | | |
| HEAT-OUT-BEK | Exterior Heat-Zone brick extension kit | HTI 1 | \$ 73 | 8 | 21 | 21 | 14 | Y |

| Venting Notes | | | | | |
|--|--|--|--|--|--|
| Requires 6-5/8" SLP pipe. See Venting section. | | | | | |
| Approved for use with PVLP-SLP, PVI-SLP-B and PVV-SLP with power vent wire harness and IFT-RC400 remote (order separately). See venting section of manual. | | | | | |

COSMO 36

Includes:

- 14,500 - 20,500 Btu/Hour Input (NG)
- 14,000 - 19,000 Btu/Hour Input (LP)
- IntelliFire Touch ignition system
- Black glass media
- Gas flex connector
- Tempered glass
- Junction box
- Battery backup
- Manual gas shut-off valve
- 4" x 6-5/8" top vent collar



Special Considerations:

- If ordering lights or fan, MUST order IFT-RC400
- If installing Passive Heat Kit you CANNOT use a fan
- Glass media CANNOT be used with traditional log set

Required to Complete - Sold Separately: • Front

| | | Disc. Code | MSRP USD | 004 IA | 010 PA | 014 CA | 016 NC | EXP |
|---------------|---|---------------|-------------|-----------|-----------|-----------|-----------|-----|
| COSMO36-IFT-B | COSMO 36" direct vent gas fireplace with IntelliFire Touch ignition system (NG) | HNG 1 | \$ 3,019 | Y | Y | Y | Y | N |

Fronts - Non-Operable (Required to Complete)

Clean Face Trim

| | | | | | | | | |
|------------|------------------------------|-------|--------|----|----|----|----|---|
| CFTF-36-BK | Clean Face Trim - Black | HTI 1 | \$ 459 | Y | Y | Y | 14 | Y |
| CFTF-36-NB | Clean Face Trim - New Bronze | HTI 1 | \$ 529 | 14 | 14 | 14 | 14 | Y |
| CFTF-36-GM | Clean Face Trim - Gun Metal | HTI 1 | \$ 529 | 14 | 14 | 14 | 14 | Y |

Martini

| | | | | | | | | |
|----------------|----------------------------|-------|--------|----|----|----|----|---|
| MAR-COSMO36-GM | Martini front - Gun Metal | HNG 1 | \$ 769 | 14 | 14 | 14 | 14 | Y |
| MAR-COSMO36-NB | Martini front - New Bronze | HNG 1 | \$ 769 | 14 | 14 | 14 | 14 | Y |



Clean Face Trim

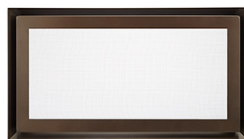

Martini

Conversion Kit

Conversion Kit

| | | | | | | | | |
|--------------|-------------------|-------|-------|---|---|---|---|---|
| LPK-36LINEAR | LP conversion kit | HTI 1 | \$ 99 | Y | Y | Y | Y | Y |
|--------------|-------------------|-------|-------|---|---|---|---|---|

Gas Logs - Log Set Option

Driftwood Log Set

| | | | | | | | | |
|---------------|-------------------|-------|--------|---|----|----|----|---|
| DRIFTWOOD-C36 | Driftwood log set | HNG 1 | \$ 419 | Y | 14 | 14 | 14 | Y |
|---------------|-------------------|-------|--------|---|----|----|----|---|

Traditional Log Set

| | | | | | | | | |
|--------------|---|-------|--------|----|----|----|----|---|
| LOGS-COSMO36 | Traditional log set (includes new burner) | HNG 1 | \$ 399 | 14 | 21 | 14 | 14 | Y |
|--------------|---|-------|--------|----|----|----|----|---|

| Media | | | | | | | | | |
|---------------------------------|--|-------|----|-------|----|----|----|----|---|
| Crushed Glass Media | | | | | | | | | |
| MEDIA-CRYSTAL | Glass media, Crystal (translucent white) | HTI 1 | \$ | 123 | Y | Y | Y | Y | Y |
| MEDIA-COBALT | Glass media, Cobalt Blue | HTI 1 | \$ | 123 | Y | 14 | 14 | 14 | Y |
| MEDIA-AMBER | Glass media, Amber | HTI 1 | \$ | 123 | Y | 14 | Y | 14 | Y |
| Glass Bead Media | | | | | | | | | |
| MEDIA-WH2-GEMS | Glass beads - White | HTI 1 | \$ | 189 | 14 | 21 | 14 | 14 | Y |
| MEDIA-CL2-GEMS | Glass beads - Clear | HTI 1 | \$ | 189 | 14 | 21 | 14 | 14 | Y |
| MEDIA-BK2-GEMS | Glass beads, Black | HTI 1 | \$ | 189 | Y | 21 | Y | 14 | Y |
| MEDIA | | | | | | | | | |
| STONES-C3642 | River Rock Stone Set (Cannot be used with glass media) | HNG 1 | \$ | 419 | Y | Y | Y | 14 | Y |
| Lighting | | | | | | | | | |
| LED Accent Light | | | | | | | | | |
| LED-LINEAR | LED accent lights (must order LED-SWITCH for multi-color selection) | HTI 1 | \$ | 379 | Y | Y | Y | Y | Y |
| Refractory | | | | | | | | | |
| Glass Refractory | | | | | | | | | |
| GLASS-36LINEAR | Fade-resistant reflective black glass interior panels | HTI 1 | \$ | 609 | Y | 14 | 14 | 14 | Y |
| Fans | | | | | | | | | |
| Fan | | | | | | | | | |
| GFK-160C | Fan kit 160 CFM (fan only) | HTI 1 | \$ | 259 | Y | Y | Y | Y | Y |
| Heat Management | | | | | | | | | |
| Heat Management | | | | | | | | | |
| PH-SIDETRIM | Passive Heat trim kit for side discharge (includes 2 side registers)(Starting collars sold separately) | HTI 1 | \$ | 110 | Y | Y | Y | Y | Y |
| PH-LINEAR | Starting Collars for Non-Ducted Passive Heat (Required when using passive heat - For use with Front, Side, Top Discharges) | HTI 1 | \$ | 199 | Y | Y | Y | Y | Y |
| PH-FRTRIM-36 | Passive Heat Vent Trim Kit For Front Discharge (36")(Starting collars sold separately) | HTI 1 | \$ | 209 | Y | Y | Y | 21 | Y |
| Heat Out Kit | | | | | | | | | |
| HEAT-OUT-GAS | Heat out kit (includes termination cap, 25' of 6" round duct, fireplace adapter, damper, wall switch and 350CFM fan at termination) | HTI 1 | \$ | 1,529 | Y | 14 | Y | 14 | Y |
| Heat Zone Kit | | | | | | | | | |
| HEAT-ZONE-GAS | Heat-Zone Kit includes fan, 20' of 6" round duct, vent, wall adapter & on/off control. Wire Plug Assembly 26D0619 required if controlling w/RC400 remote. Used in IFT units with ACM & not a GFK fan. Compatible for up to 2 HEAT-ZONE-GAS kits. See manual. | HTI 1 | \$ | 569 | Y | Y | Y | Y | Y |
| Control, remotes, wall switches | | | | | | | | | |
| Battery Back Up | | | | | | | | | |
| BATTERY-WSK | Battery backup wall switch kit for units with IFT control systems. Includes: On/Off Wall Switch, USB-C Port, Battery Backup, Cover Plate, 12' Wire Harness | HTI 1 | \$ | 189 | Y | 14 | Y | 14 | Y |

| IntelliFire app | | | | | | | | |
|---|---|-------|--------|---|---|----|----|---|
| IFT-WFM | IntelliFire Wi-Fi Module that works with the IntelliFire iOS and Android app. Use to control all the features of your fireplace via a smart device. An RC400, RC450 or RC150 is required for thermostat control | HTI 1 | \$ 229 | Y | Y | Y | Y | Y |
| IntelliFire Touch Controls - Aux Module | | | | | | | | |
| IFT-ACM | IntelliFire Touch AUX Module. Must order if adding Fan, Lights or Power Vent and want to use the IFT-WFM. Do not need to order if using IFT-RC400 (includes IFT-ACM). | HTI 1 | \$ 98 | Y | Y | 14 | 14 | Y |
| Remote/Wall Switch/Wall Thermostat | | | | | | | | |
| LED-SWITCH | 3 toggle wall switch for multi-color selection | HTI 1 | \$ 141 | Y | Y | 14 | 14 | Y |
| Touch Screen Remote | | | | | | | | |
| IFT-RC400 | IntelliFire Touch black remote control, docking station and auxiliary control module (on/off, flame height, thermostat mode, fan control, child lock, cold climate, timer mode, hot indicator, lights, on-screen maintenance and troubleshooting notifications) | HTI 1 | \$ 389 | Y | Y | Y | Y | Y |
| Wall Switch | | | | | | | | |
| IFT-RC150-HNG | IntelliFire Touch white wireless wall switch (on/off, cold climate, battery strength indicator) | HNG 1 | \$ 121 | Y | Y | Y | Y | Y |



Battery Back Up



IntelliFire app

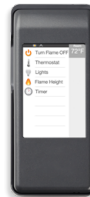

Touch Screen Remote



Wall Switch

Venting

Brick Extension Kit

| | | | | | | | | |
|--------------|--|-------|-------|---|----|----|----|---|
| HEAT-OUT-BEK | Exterior Heat-Zone brick extension kit | HTI 1 | \$ 73 | 8 | 21 | 21 | 14 | Y |
|--------------|--|-------|-------|---|----|----|----|---|

Venting Notes

Requires 6-5/8" SLP pipe. Must have a 12" minimum vertical vent before attaching 90 elbow to unit. See Venting section.
 Approved for use with PVLP-SLP, PVI-SLP-B and PVV-SLP with power vent wire harness and IFT-RC400 remote (order separately). See venting section of manual.

COSMO 42

Includes:

- 17,500 - 25,250 Btu/Hour Input (NG)
- 17,500 - 25,500 Btu/Hour Input (LP)
- IntelliFire Touch ignition system
- Black glass media
- Gas flex connector
- Tempered glass
- Junction box
- Battery backup
- Manual gas shut-off valve
- 4" x 6-5/8" top vent collar



Special Considerations:

- If ordering lights or fan, MUST order IFT-RC400
- If installing Passive Heat Kit you CANNOT use a fan
- Glass media CANNOT be used with traditional log set

Required to Complete - Sold Separately: • Front

| | | Disc. Code | MSRP USD | 004 IA | 010 PA | 014 CA | 016 NC | EXP |
|---------------|---|------------|----------|--------|--------|--------|--------|-----|
| COSMO42-IFT-B | COSMO 42" direct vent gas fireplace with IntelliFire Touch ignition system (NG) | HNG 1 | \$ 3,349 | Y | Y | Y | Y | N |

Fronts - Non-Operable (Required to Complete)

Clean Face Trim

| | | | | | | | | |
|------------|-----------------------------------|-------|----------|----|----|----|----|---|
| CFTF-42-BK | Clean Face Trim - Black | HTI 1 | \$ 469 | Y | Y | Y | Y | Y |
| CFTF-42-NB | Clean Face Trim - New Bronze | HTI 1 | \$ 539 | 14 | 14 | 14 | 14 | Y |
| CFTF-42-GM | Clean Face Trim - Gun Metal | HTI 1 | \$ 539 | Y | 14 | 14 | Y | Y |
| CFTF-42-EB | Clean Face Trim - Ebony | HNG 1 | \$ 989 | 14 | 14 | 14 | 14 | Y |
| CFTF-42-SS | Clean Face Trim - Stainless Steel | HNG 1 | \$ 1,159 | 14 | 14 | 14 | 14 | Y |

Martini

| | | | | | | | | |
|----------------|----------------------------|-------|----------|----|----|----|----|---|
| MAR-COSMO42-NB | Martini front - New Bronze | HNG 1 | \$ 789 | 14 | 14 | 14 | 14 | Y |
| MAR-COSMO42-GM | Martini front - Gun Metal | HNG 1 | \$ 789 | 14 | 14 | 14 | 14 | Y |
| MAR-COSMO42-EB | Martini front - Ebony | HNG 1 | \$ 1,349 | Y | 14 | Y | 14 | Y |



Clean Face Trim

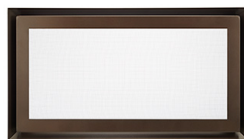

Martini

Conversion Kit

Conversion Kit

| | | | | | | | | |
|--------------|-------------------|-------|-------|---|---|---|---|---|
| LPK-42LINEAR | LP conversion kit | HTI 1 | \$ 99 | Y | Y | Y | Y | Y |
|--------------|-------------------|-------|-------|---|---|---|---|---|

Gas Logs - Log Set Option

Driftwood Log Set

| | | | | | | | | |
|---------------|-------------------|-------|--------|---|---|---|---|---|
| DRIFTWOOD-C42 | Driftwood log set | HNG 1 | \$ 479 | Y | Y | Y | Y | Y |
|---------------|-------------------|-------|--------|---|---|---|---|---|

| Traditional Log Set | | | | | | | | | |
|---------------------------------|--|-------|----|-------|----|----|----|----|---|
| LOGS-COSMO42 | Traditional log set (includes new burner) | HNG 1 | \$ | 429 | Y | Y | Y | 14 | Y |
| Media | | | | | | | | | |
| Crushed Glass Media | | | | | | | | | |
| MEDIA-CRYSTAL | Glass media, Crystal (translucent white) | HTI 1 | \$ | 123 | Y | Y | Y | Y | Y |
| MEDIA-AMBER | Glass media, Amber | HTI 1 | \$ | 123 | Y | 14 | Y | 14 | Y |
| MEDIA-COBALT | Glass media, Cobalt Blue | HTI 1 | \$ | 123 | Y | 14 | 14 | 14 | Y |
| Glass Bead Media | | | | | | | | | |
| MEDIA-BK2-GEMS | Glass beads, Black | HTI 1 | \$ | 189 | Y | 21 | Y | 14 | Y |
| MEDIA-CL2-GEMS | Glass beads - Clear | HTI 1 | \$ | 189 | 14 | 21 | 14 | 14 | Y |
| MEDIA-WH2-GEMS | Glass beads - White | HTI 1 | \$ | 189 | 14 | 21 | 14 | 14 | Y |
| MEDIA | | | | | | | | | |
| STONES-C3642 | River Rock Stone Set (Cannot be used with glass media) | HNG 1 | \$ | 419 | Y | Y | Y | 14 | Y |
| Lighting | | | | | | | | | |
| LED Accent Light | | | | | | | | | |
| LED-LINEAR | LED accent lights (must order LED-SWITCH for multi-color selection) | HTI 1 | \$ | 379 | Y | Y | Y | Y | Y |
| Refractory | | | | | | | | | |
| Glass Refractory | | | | | | | | | |
| GLASS-42LINEAR | Fade-resistant reflective black glass interior panels | HTI 1 | \$ | 629 | Y | Y | Y | Y | Y |
| Fans | | | | | | | | | |
| Fan | | | | | | | | | |
| GFK-160C | Fan kit 160 CFM (fan only) | HTI 1 | \$ | 259 | Y | Y | Y | Y | Y |
| Heat Management | | | | | | | | | |
| Heat Management | | | | | | | | | |
| PH-SIDETRIM | Passive Heat trim kit for side discharge (includes 2 side registers)(Starting collars sold separately) | HTI 1 | \$ | 110 | Y | Y | Y | Y | Y |
| PH-LINEAR | Starting Collars for Non-Ducted Passive Heat (Required when using passive heat - For use with Front, Side, Top Discharges) | HTI 1 | \$ | 199 | Y | Y | Y | Y | Y |
| PH-FRTRIM-42 | Passive Heat Vent Trim Kit For Front Discharge (42")(Starting collars sold separately) | HTI 1 | \$ | 209 | Y | Y | Y | Y | Y |
| Heat Out Kit | | | | | | | | | |
| HEAT-OUT-GAS | Heat out kit (includes termination cap, 25' of 6" round duct, fireplace adapter, damper, wall switch and 350CFM fan at termination) | HTI 1 | \$ | 1,529 | Y | 14 | Y | 14 | Y |
| Heat Zone Kit | | | | | | | | | |
| HEAT-ZONE-GAS | Heat-Zone Kit includes fan, 20' of 6" round duct, vent, wall adapter & on/off control. Wire Plug Assembly 26D0619 required if controlling w/RC400 remote. Used in IFT units with ACM & not a GFK fan. Compatible for up to 2 HEAT-ZONE-GAS kits. See manual. | HTI 1 | \$ | 569 | Y | Y | Y | Y | Y |
| Control, remotes, wall switches | | | | | | | | | |
| Battery Back Up | | | | | | | | | |
| BATTERY-WSK | Battery backup wall switch kit for units with IFT control systems. Includes: On/Off Wall Switch, USB-C Port, Battery Backup, Cover Plate, 12' Wire Harness | HTI 1 | \$ | 189 | Y | 14 | Y | 14 | Y |

| IntelliFire app | | | | | | | | |
|---|---|-------|--------|---|---|----|----|---|
| IFT-WFM | IntelliFire Wi-Fi Module that works with the IntelliFire iOS and Android app. Use to control all the features of your fireplace via a smart device. An RC400, RC450 or RC150 is required for thermostat control | HTI 1 | \$ 229 | Y | Y | Y | Y | Y |
| IntelliFire Touch Controls - Aux Module | | | | | | | | |
| IFT-ACM | IntelliFire Touch AUX Module. Must order if adding Fan, Lights or Power Vent and want to use the IFT-WFM. Do not need to order if using IFT-RC400 (includes IFT-ACM). | HTI 1 | \$ 98 | Y | Y | 14 | 14 | Y |
| Remote/Wall Switch/Wall Thermostat | | | | | | | | |
| LED-SWITCH | 3 toggle wall switch for multi-color selection | HTI 1 | \$ 141 | Y | Y | 14 | 14 | Y |
| Touch Screen Remote | | | | | | | | |
| IFT-RC400 | IntelliFire Touch black remote control, docking station and auxiliary control module (on/off, flame height, thermostat mode, fan control, child lock, cold climate, timer mode, hot indicator, lights, on-screen maintenance and troubleshooting notifications) | HTI 1 | \$ 389 | Y | Y | Y | Y | Y |
| Wall Switch | | | | | | | | |
| IFT-RC150-HNG | IntelliFire Touch white wireless wall switch (on/off, cold climate, battery strength indicator) | HNG 1 | \$ 121 | Y | Y | Y | Y | Y |



Battery Back Up



IntelliFire app

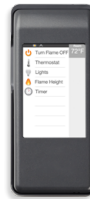

Touch Screen Remote



Wall Switch

| Venting | | | | | | | | |
|---------------------|--|-------|-------|---|----|----|----|---|
| Brick Extension Kit | | | | | | | | |
| HEAT-OUT-BEK | Exterior Heat-Zone brick extension kit | HTI 1 | \$ 73 | 8 | 21 | 21 | 14 | Y |

| Venting Notes | |
|--|--|
| Requires 6-5/8" SLP pipe. Must have a 12" minimum vertical vent before attaching a 90° elbow to unit. See Venting section. | |
| Approved for use with PVLP-SLP, PVI-SLP-B and PVV-SLP with power vent wire harness and IFT-RC400 remote (order separately). See venting section of manual. | |

MEZZO 36

Includes:

- 17,500 - 30,000 Btu/Hour Input (NG)
- 15,500 - 29,000 Btu/Hour Input (LP)
- Clear LED dimmable lights
- Black glass refractory
- RC400 Remote Control
- Ceramic Glass
- Junction box
- Gas flex connector
- Battery backup
- IntelliFire Touch ignition system
- Not available for sale in Rhode Island



Special Considerations:

- If installing driftwood log set & river rock stones, only 1 stone set can be used
- If installing only river rock stones, 2 sets can be used

Required to Complete - Sold Separately: • Front • Crushed Glass Media

| | | Disc. Code | MSRP USD | 004 IA | 010 PA | 014 CA | 016 NC | EXP |
|-----------|---|------------|----------|--------|--------|--------|--------|-----|
| MEZZO36-C | MEZZO 36 top direct vent with IntelliFire Touch Ignition (NG) | HNG 1 | \$ 5,009 | 14 | 14 | Y | 14 | N |

Fronts - Non-Operable (Required to Complete)

Clean Face Trim

| | | | | | | | | |
|-------------|-----------------------------------|-------|--------|----|----|----|----|---|
| CFT-36-BK-C | Clean face trim - Black | HTI 1 | \$ 439 | Y | Y | Y | Y | Y |
| CFT-36-GM-C | Clean face trim - Gun Metal | HTI 1 | \$ 489 | 14 | 14 | 14 | 14 | Y |
| CFT-36-NB-C | Clean Face Trim - New Bronze | HTI 1 | \$ 489 | 14 | 14 | 14 | 14 | Y |
| CFT-36-SS-C | Clean face trim - Stainless Steel | HTI 1 | \$ 749 | 14 | 14 | 14 | 14 | Y |

Loft Forge 36

| | | | | | | | | |
|--------------|--|-------|----------|----|----|----|----|---|
| LOFTFORGE-36 | Loft Forge hand-crafted front. Max finishing material depth = 1" | HNG 1 | \$ 1,389 | 14 | 14 | 14 | 14 | N |
|--------------|--|-------|----------|----|----|----|----|---|

Quattro 36

| | | | | | | | | |
|----------|----------------------------|-------|--------|----|----|----|----|---|
| QT-36-BK | Quattro front - Black | HNG 1 | \$ 759 | 14 | 14 | 14 | 14 | N |
| QT-36-NB | Quattro front - New Bronze | HNG 1 | \$ 799 | 14 | 14 | 14 | 14 | N |



Clean Face Trim



Loft Forge 36



Quattro 36

Media (Required to Complete)

Crushed Glass Media

| | | | | | | | | |
|-----------------|--|-------|--------|----|----|----|----|---|
| MEDIA-CLEAR-36 | Glass media, crystal (translucent white) | HTI 1 | \$ 129 | Y | Y | Y | 14 | Y |
| MEDIA-RED-36 | Glass media, scarlet (red) | HTI 1 | \$ 259 | 14 | 21 | 14 | 14 | Y |
| MEDIA-FOG-36 | Iced fog media (requires black spray paint finish) | HNG 1 | \$ 259 | Y | 21 | Y | 14 | Y |
| MEDIA-EBONY-36 | Glass media, ebony (black) | HTI 1 | \$ 259 | Y | 21 | 14 | 14 | Y |
| MEDIA-COBALT-36 | Glass media, cobalt (blue) | HTI 1 | \$ 259 | 14 | 21 | 14 | 14 | Y |
| MEDIA-AMBER-36 | Glass media, amber | HTI 1 | \$ 259 | 14 | 21 | 14 | 14 | Y |

| MEDIA | | | | | | | | | | |
|---------------------------------|--|-------|----|-------|----|----|----|----|---|--|
| STONES-36 | River Rock Stone Set (requires media) | HNG 1 | \$ | 129 | Y | 28 | 21 | 28 | Y | |
| Conversion Kit | | | | | | | | | | |
| Conversion Kit | | | | | | | | | | |
| LPK-4836 | LP conversion kit | HTI 1 | \$ | 99 | Y | Y | 14 | Y | Y | |
| NGK-MC-C | NG Conversion Kit | HTI 1 | \$ | 99 | 14 | 14 | 14 | 14 | Y | |
| Gas Logs - Log Set Option | | | | | | | | | | |
| Driftwood Log Set | | | | | | | | | | |
| DRIFTLOGS-36 | Driftwood Log Set (requires media) | HNG 1 | \$ | 399 | 21 | 14 | 14 | 14 | Y | |
| Natural Log Set | | | | | | | | | | |
| LOGS-36 | Natural Log set (requires media) | HTI 1 | \$ | 279 | 14 | 14 | 14 | 14 | Y | |
| Heat Management | | | | | | | | | | |
| Heat Management | | | | | | | | | | |
| PH-SIDETRIM | Passive Heat trim kit for side discharge (includes 2 side registers)(Starting collars sold separately) | HTI 1 | \$ | 110 | Y | Y | Y | Y | Y | |
| PH-MCE | Starting Collars for Non-Ducted Passive Heat (Required when using passive heat - For use with Front, Side, Top Discharges) | HTI 1 | \$ | 179 | Y | Y | Y | Y | Y | |
| PH-FRTRIM-36 | Passive Heat Vent Trim Kit For Front Discharge (36")(Starting collars sold separately) | HTI 1 | \$ | 209 | Y | Y | Y | 21 | Y | |
| Heat Management - Ducted | | | | | | | | | | |
| PHTRIM-MCE-36 | Ducted vent trim for front discharge using ducted Passive Heat (PHFR-MCE-36) | HTI 1 | \$ | 249 | 14 | 14 | 14 | 14 | Y | |
| PHSI-MCE | Ducted Passive Heat kit for side discharge (includes duct and 2 side registers) | HTI 1 | \$ | 569 | 14 | 21 | 14 | 14 | Y | |
| PHFR-MCE-36 | Ducted Passive Heat kit for front discharge (requires PHTRIM-MCE-36 front trim) | HTI 1 | \$ | 629 | 14 | 14 | 14 | 14 | Y | |
| Heat Out Kit | | | | | | | | | | |
| HEAT-OUT-GAS | Heat out kit (includes termination cap, 25' of 6" round duct, fireplace adapter, damper, wall switch and 350CFM fan at termination) | HTI 1 | \$ | 1,529 | Y | 14 | Y | 14 | Y | |
| Heat Zone Kit | | | | | | | | | | |
| HZLIN-ADP | Heat Zone adaptor, must order for using HEAT-ZONE-GAS | HTI 1 | \$ | 179 | Y | Y | Y | 14 | Y | |
| HEAT-ZONE-GAS | Heat-Zone Kit includes fan, 20' of 6" round duct, vent, wall adapter & on/off control. Wire Plug Assembly 26D0619 required if controlling w/RC400 remote. Used in IFT units with ACM & not a GFK fan. Compatible for up to 2 HEAT-ZONE-GAS kits. See manual. | HTI 1 | \$ | 569 | Y | Y | Y | Y | Y | |
| Control, remotes, wall switches | | | | | | | | | | |
| Battery Back Up | | | | | | | | | | |
| BATTERY-WSK | Battery backup wall switch kit for units with IFT control systems. Includes: On/Off Wall Switch, USB-C Port, Battery Backup, Cover Plate, 12' Wire Harness | HTI 1 | \$ | 189 | Y | 14 | Y | 14 | Y | |
| IntelliFire app | | | | | | | | | | |
| IFT-WFM | IntelliFire Wi-Fi Module that works with the IntelliFire iOS and Android app. Use to control all the features of your fireplace via a smart device. An RC400, RC450 or RC150 is required for thermostat control | HTI 1 | \$ | 229 | Y | Y | Y | Y | Y | |

Touch Screen Remote

| | | | | | | | | |
|-----------|---|-------|--------|---|---|---|---|---|
| IFT-RC400 | IntelliFire Touch black remote control, docking station and auxiliary control module (on/off, flame height, thermostat mode, fan control, child lock, cold climate, timer mode, hot indicator, lights, on-screen maintenance and troubleshooting notifications) | HTI 1 | \$ 389 | Y | Y | Y | Y | Y |
|-----------|---|-------|--------|---|---|---|---|---|

Wall Switch

| | | | | | | | | |
|---------------|---|-------|--------|---|---|---|---|---|
| IFT-RC150-HNG | IntelliFire Touch white wireless wall switch (on/off, cold climate, battery strength indicator) | HNG 1 | \$ 121 | Y | Y | Y | Y | Y |
|---------------|---|-------|--------|---|---|---|---|---|



Battery Back Up



IntelliFire app

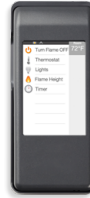

Touch Screen Remote



Wall Switch

Venting

Brick Extension Kit

| | | | | | | | | |
|--------------|--|-------|-------|---|----|----|----|---|
| HEAT-OUT-BEK | Exterior Heat-Zone brick extension kit | HTI 1 | \$ 73 | 8 | 21 | 21 | 14 | Y |
|--------------|--|-------|-------|---|----|----|----|---|

Venting Notes

Requires 8" DVP pipe. Must have a 18" minimum vertical vent before attaching a 90° elbow to unit. See Venting section.

Approved for use with PVLP-SLP, PVI-SLP-B and PVV-SLP with power vent wire harness (order separately) and IFT-RC400 remote. See venting section of manual.

MEZZO 48

Includes:

- 21,000 - 40,000 Btu/Hour Input (NG)
- 19,500 - 36,000 Btu/Hour Input (LP)
- Clear LED dimmable Lights
- Black glass refractory
- RC400 Remote Control
- Ceramic glass
- Junction box
- Gas flex connector
- Battery backup
- IntelliFire Touch ignition system



Special Considerations:

- If installing driftwood log set & river rock stones, only 1 stone set can be used
- If installing only river rock stones, 2 sets can be used

Required to Complete - Sold Separately: • Front • Crushed Glass Media

| | | Disc. Code | MSRP USD | 004 IA | 010 PA | 014 CA | 016 NC | EXP |
|-----------|---|------------|----------|--------|--------|--------|--------|-----|
| MEZZO48-C | MEZZO 48 top direct vent fireplace with IntelliFire Touch Ignition (NG) | HNG 1 | \$ 6,229 | Y | Y | Y | Y | N |

Fronts - Non-Operable (Required to Complete)

Clean Face Trim

| | | | | | | | | |
|-------------|-----------------------------------|-------|--------|----|----|----|----|---|
| CFT-48-BK-C | Clean face trim - Black | HTI 1 | \$ 469 | Y | Y | Y | Y | Y |
| CFT-48-NB-C | Clean Face Trim - New Bronze | HTI 1 | \$ 509 | 14 | 14 | 14 | 14 | Y |
| CFT-48-GM-C | Clean face trim - Gun Metal | HTI 1 | \$ 509 | 14 | 14 | 14 | 14 | Y |
| CFT-48-SS-C | Clean face trim - Stainless Steel | HTI 1 | \$ 849 | 14 | 14 | 14 | 14 | Y |

Loft Forge 48

| | | | | | | | | |
|--------------|--|-------|----------|----|----|----|----|---|
| LOFTFORGE-48 | Loft Forge hand-crafted front. Max finishing material depth = 1" | HNG 1 | \$ 1,509 | 14 | 14 | 14 | 14 | N |
|--------------|--|-------|----------|----|----|----|----|---|

Quattro 48

| | | | | | | | | |
|----------|----------------------------|-------|--------|----|----|----|----|---|
| QT-48-BK | Quattro front - Black | HNG 1 | \$ 809 | 14 | 14 | 14 | 14 | N |
| QT-48-NB | Quattro front - New Bronze | HNG 1 | \$ 849 | 14 | 14 | 14 | 14 | N |



Clean Face Trim



Loft Forge 48



Quattro 48

Media (Required to Complete)

Crushed Glass Media

| | | | | | | | | |
|-----------------|--|-------|--------|----|----|----|----|---|
| MEDIA-CLEAR-48 | Glass media, crystal (translucent white) | HTI 1 | \$ 259 | Y | Y | Y | Y | Y |
| MEDIA-RED-48 | Glass media, scarlet (red) | HTI 1 | \$ 369 | 14 | 21 | 14 | 14 | Y |
| MEDIA-FOG-48 | Iced fog media (requires black spray paint finish) | HNG 1 | \$ 369 | Y | Y | Y | 14 | Y |
| MEDIA-EBONY-48 | Glass media, ebony (black) | HTI 1 | \$ 369 | Y | Y | Y | Y | Y |
| MEDIA-COBALT-48 | Glass media, cobalt (blue) | HTI 1 | \$ 369 | Y | 21 | Y | 14 | Y |
| MEDIA-AMBER-48 | Glass media, amber | HTI 1 | \$ 369 | Y | Y | Y | Y | Y |

| MEDIA | | | | | | | | | | |
|---------------------------------|--|-------|----|-------|----|----|----|----|---|--|
| STONES-48 | River Rock Stone Set (requires media) | HNG 1 | \$ | 169 | Y | 14 | Y | 14 | Y | |
| Conversion Kit | | | | | | | | | | |
| Conversion Kit | | | | | | | | | | |
| LPK-6048 | LP conversion kit | HTI 1 | \$ | 99 | Y | Y | Y | Y | Y | |
| NGK-MC-C | NG Conversion Kit | HTI 1 | \$ | 99 | 14 | 14 | 14 | 14 | Y | |
| Gas Logs - Log Set Option | | | | | | | | | | |
| Driftwood Log Set | | | | | | | | | | |
| DRIFTLOGS-48 | Driftwood Log Set (requires media) | HNG 1 | \$ | 539 | Y | Y | Y | 14 | Y | |
| Natural Log Set | | | | | | | | | | |
| LOGS-48 | Natural Log Set (requires media) | HTI 1 | \$ | 399 | Y | Y | Y | 14 | Y | |
| Heat Management | | | | | | | | | | |
| Heat Management | | | | | | | | | | |
| PH-SIDETRIM | Passive Heat trim kit for side discharge (includes 2 side registers)(Starting collars sold separately) | HTI 1 | \$ | 110 | Y | Y | Y | Y | Y | |
| PH-MCE | Starting Collars for Non-Ducted Passive Heat (Required when using passive heat - For use with Front, Side, Top Discharges) | HTI 1 | \$ | 179 | Y | Y | Y | Y | Y | |
| PH-FRTRIM-48 | Passive Heat Vent Trim Kit For Front Discharge (48")(Starting collars sold separately) | HTI 1 | \$ | 219 | Y | Y | Y | Y | Y | |
| Heat Management - Ducted | | | | | | | | | | |
| PHTRIM-MCE-48 | Ducted vent trim for front discharge using ducted Passive Heat (PHFR-MCE-48) | HTI 1 | \$ | 269 | 14 | 14 | 14 | Y | Y | |
| PHSI-MCE | Ducted Passive Heat kit for side discharge (includes duct and 2 side registers) | HTI 1 | \$ | 569 | 14 | 21 | 14 | 14 | Y | |
| PHFR-MCE-48 | Ducted Passive Heat kit for front discharge (requires PHTRIM-MCE-48 front trim) | HTI 1 | \$ | 689 | 14 | 14 | Y | Y | Y | |
| Heat Out Kit | | | | | | | | | | |
| HEAT-OUT-GAS | Heat out kit (includes termination cap, 25' of 6" round duct, fireplace adapter, damper, wall switch and 350CFM fan at termination) | HTI 1 | \$ | 1,529 | Y | 14 | Y | 14 | Y | |
| Heat Zone Kit | | | | | | | | | | |
| HZLIN-ADP | Heat Zone adaptor, must order for using HEAT-ZONE-GAS | HTI 1 | \$ | 179 | Y | Y | Y | 14 | Y | |
| HEAT-ZONE-GAS | Heat-Zone Kit includes fan, 20' of 6" round duct, vent, wall adapter & on/off control. Wire Plug Assembly 26D0619 required if controlling w/RC400 remote. Used in IFT units with ACM & not a GFK fan. Compatible for up to 2 HEAT-ZONE-GAS kits. See manual. | HTI 1 | \$ | 569 | Y | Y | Y | Y | Y | |
| Control, remotes, wall switches | | | | | | | | | | |
| Battery Back Up | | | | | | | | | | |
| BATTERY-WSK | Battery backup wall switch kit for units with IFT control systems. Includes: On/Off Wall Switch, USB-C Port, Battery Backup, Cover Plate, 12' Wire Harness | HTI 1 | \$ | 189 | Y | 14 | Y | 14 | Y | |
| IntelliFire app | | | | | | | | | | |
| IFT-WFM | IntelliFire Wi-Fi Module that works with the IntelliFire iOS and Android app. Use to control all the features of your fireplace via a smart device. An RC400, RC450 or RC150 is required for thermostat control | HTI 1 | \$ | 229 | Y | Y | Y | Y | Y | |

Touch Screen Remote

| | | | | | | | | |
|-----------|---|-------|--------|---|---|---|---|---|
| IFT-RC400 | IntelliFire Touch black remote control, docking station and auxiliary control module (on/off, flame height, thermostat mode, fan control, child lock, cold climate, timer mode, hot indicator, lights, on-screen maintenance and troubleshooting notifications) | HTI 1 | \$ 389 | Y | Y | Y | Y | Y |
|-----------|---|-------|--------|---|---|---|---|---|

Wall Switch

| | | | | | | | | |
|---------------|---|-------|--------|---|---|---|---|---|
| IFT-RC150-HNG | IntelliFire Touch white wireless wall switch (on/off, cold climate, battery strength indicator) | HNG 1 | \$ 121 | Y | Y | Y | Y | Y |
|---------------|---|-------|--------|---|---|---|---|---|



Battery Back Up



IntelliFire app

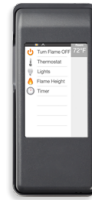

Touch Screen Remote



Wall Switch

Venting

Brick Extension Kit

| | | | | | | | | |
|--------------|--|-------|-------|---|----|----|----|---|
| HEAT-OUT-BEK | Exterior Heat-Zone brick extension kit | HTI 1 | \$ 73 | 8 | 21 | 21 | 14 | Y |
|--------------|--|-------|-------|---|----|----|----|---|

Venting Notes

Requires 8" DVP pipe. Must have a 18" minimum vertical vent before attaching a 90° elbow to unit. See Venting section.
 Approved for use with PVLP-SLP, PVI-SLP-B and PVV-SLP with power vent wire harness (order separately) and IFT-RC400 remote. See venting section of manual.

MEZZO 60

Includes:

- 26,000 - 50,000 Btu/Hour Input (NG)
- 22,000 - 41,000 Btu/Hour Input (LP)
- Clear LED dimmable lights
- Black glass refractory
- RC400 Remote Control
- Ceramic glass
- Junction box
- Gas flex connector
- Battery backup
- IntelliFire Touch ignition system



Special Considerations:

- If installing driftwood log set & river rock stones, only 1 stone set can be used
- If installing only river rock stones, 2 sets can be used

Required to Complete - Sold Separately: • Front • Crushed Glass Media

| | | Disc. Code | MSRP USD | 004 IA | 010 PA | 014 CA | 016 NC | EXP |
|-----------|---|------------|----------|--------|--------|--------|--------|-----|
| MEZZO60-C | MEZZO 60 top direct vent fireplace with IntelliFire Touch Ignition (NG) | HNG 1 | \$ 8,529 | Y | Y | Y | Y | N |

Fronts - Non-Operable (Required to Complete)

Clean Face Trim

| | | | | | | | | |
|-------------|-----------------------------------|-------|----------|----|----|----|----|---|
| CFT-60-BK-C | Clean face trim - Black | HTI 1 | \$ 789 | Y | Y | Y | Y | Y |
| CFT-60-GM-C | Clean face trim - Gun Metal | HTI 1 | \$ 829 | 14 | 14 | 14 | 14 | Y |
| CFT-60-NB-C | Clean Face Trim - New Bronze | HTI 1 | \$ 829 | 14 | 14 | 14 | 14 | Y |
| CFT-60-SS-C | Clean face trim - Stainless Steel | HTI 1 | \$ 1,099 | 14 | 14 | 14 | 14 | Y |

Loft Forge 60

| | | | | | | | | |
|--------------|--|-------|----------|----|----|----|----|---|
| LOFTFORGE-60 | Loft Forge hand-crafted front. Max finishing material depth = 1" | HNG 1 | \$ 1,829 | 14 | 14 | 14 | 14 | N |
|--------------|--|-------|----------|----|----|----|----|---|

Quattro 60

| | | | | | | | | |
|----------|----------------------------|-------|----------|----|----|----|----|---|
| QT-60-BK | Quattro front - Black | HNG 1 | \$ 1,149 | 14 | 14 | 14 | 14 | N |
| QT-60-NB | Quattro front - New Bronze | HNG 1 | \$ 1,199 | 14 | 14 | 21 | 14 | N |



Clean Face Trim



Loft Forge 60



Quattro 60

Media (Required to Complete)

Crushed Glass Media

| | | | | | | | | |
|-----------------|--|-------|--------|----|----|----|----|---|
| MEDIA-CLEAR-60 | Glass media, crystal (translucent white) | HTI 1 | \$ 369 | Y | Y | Y | Y | Y |
| MEDIA-AMBER-60 | Glass media, amber | HTI 1 | \$ 479 | Y | 21 | Y | 14 | Y |
| MEDIA-COBALT-60 | Glass media, cobalt (blue) | HTI 1 | \$ 479 | 14 | 21 | 14 | 14 | Y |
| MEDIA-EBONY-60 | Glass media, ebony (black) | HTI 1 | \$ 479 | Y | Y | Y | Y | Y |
| MEDIA-FOG-60 | Iced fog media (requires black spray paint finish) | HNG 1 | \$ 479 | Y | Y | Y | 14 | Y |
| MEDIA-RED-60 | Glass media, scarlet (red) | HTI 1 | \$ 479 | 14 | 21 | 14 | 14 | Y |

| MEDIA | | | | | | | | | | |
|---------------------------------|--|-------|----|-------|----|----|----|----|----|---|
| STONES-60 | River Rock Stone Set (requires media) | HNG 1 | \$ | 209 | Y | 14 | 14 | 14 | 14 | Y |
| Conversion Kit | | | | | | | | | | |
| Conversion Kit | | | | | | | | | | |
| LPK-7260 | LP conversion kit | HTI 1 | \$ | 99 | Y | Y | Y | Y | Y | Y |
| NGK-MC-C | NG Conversion Kit | HTI 1 | \$ | 99 | 14 | 14 | 14 | 14 | 14 | Y |
| Gas Logs - Log Set Option | | | | | | | | | | |
| Driftwood Log Set | | | | | | | | | | |
| DRIFTLOGS-60 | Driftwood Log Set (requires media) | HNG 1 | \$ | 659 | Y | 14 | Y | 14 | Y | Y |
| Natural Log Set | | | | | | | | | | |
| LOGS-60 | Natural Log Set (requires media) | HTI 1 | \$ | 529 | Y | 14 | 14 | 14 | 14 | Y |
| Heat Management | | | | | | | | | | |
| Heat Management | | | | | | | | | | |
| PH-SIDETRIM | Passive Heat trim kit for side discharge (includes 2 side registers)(Starting collars sold separately) | HTI 1 | \$ | 110 | Y | Y | Y | Y | Y | Y |
| PH-MCE | Starting Collars for Non-Ducted Passive Heat (Required when using passive heat - For use with Front, Side, Top Discharges) | HTI 1 | \$ | 179 | Y | Y | Y | Y | Y | Y |
| PH-FRTRIM-60 | Passive Heat Vent Trim Kit For Front Discharge (60")(Starting collars sold separately) | HTI 1 | \$ | 229 | Y | Y | Y | 14 | Y | Y |
| Heat Management - Ducted | | | | | | | | | | |
| PHTRIM-MCE-60 | Ducted vent trim for front discharge using ducted Passive Heat (PHFR-MCE-60) | HTI 1 | \$ | 279 | Y | Y | 14 | 14 | N | N |
| PHFR-MCE-60 | Ducted Passive Heat kit for front discharge (requires PHTRIM-MCE-60 front trim) | HTI 1 | \$ | 759 | Y | Y | Y | 14 | Y | Y |
| Heat Out Kit | | | | | | | | | | |
| HEAT-OUT-GAS | Heat out kit (includes termination cap, 25' of 6" round duct, fireplace adapter, damper, wall switch and 350CFM fan at termination) | HTI 1 | \$ | 1,529 | Y | 14 | Y | 14 | Y | Y |
| Heat Zone Kit | | | | | | | | | | |
| HZLIN-ADP | Heat Zone adaptor, must order for using HEAT-ZONE-GAS | HTI 1 | \$ | 179 | Y | Y | Y | 14 | Y | Y |
| HEAT-ZONE-GAS | Heat-Zone Kit includes fan, 20' of 6" round duct, vent, wall adapter & on/off control. Wire Plug Assembly 26D0619 required if controlling w/RC400 remote. Used in IFT units with ACM & not a GFK fan. Compatible for up to 2 HEAT-ZONE-GAS kits. See manual. | HTI 1 | \$ | 569 | Y | Y | Y | Y | Y | Y |
| Control, remotes, wall switches | | | | | | | | | | |
| Battery Back Up | | | | | | | | | | |
| BATTERY-WSK | Battery backup wall switch kit for units with IFT control systems. Includes: On/Off Wall Switch, USB-C Port, Battery Backup, Cover Plate, 12' Wire Harness | HTI 1 | \$ | 189 | Y | 14 | Y | 14 | Y | Y |
| IntelliFire app | | | | | | | | | | |
| IFT-WFM | IntelliFire Wi-Fi Module that works with the IntelliFire iOS and Android app. Use to control all the features of your fireplace via a smart device. An RC400, RC450 or RC150 is required for thermostat control | HTI 1 | \$ | 229 | Y | Y | Y | Y | Y | Y |

Touch Screen Remote

| | | | | | | | | |
|-----------|---|-------|--------|---|---|---|---|---|
| IFT-RC400 | IntelliFire Touch black remote control, docking station and auxiliary control module (on/off, flame height, thermostat mode, fan control, child lock, cold climate, timer mode, hot indicator, lights, on-screen maintenance and troubleshooting notifications) | HTI 1 | \$ 389 | Y | Y | Y | Y | Y |
|-----------|---|-------|--------|---|---|---|---|---|

Wall Switch

| | | | | | | | | |
|---------------|---|-------|--------|---|---|---|---|---|
| IFT-RC150-HNG | IntelliFire Touch white wireless wall switch (on/off, cold climate, battery strength indicator) | HNG 1 | \$ 121 | Y | Y | Y | Y | Y |
|---------------|---|-------|--------|---|---|---|---|---|



Battery Back Up



IntelliFire app



Touch Screen Remote



Wall Switch

Venting

Brick Extension Kit

| | | | | | | | | |
|--------------|--|-------|-------|---|----|----|----|---|
| HEAT-OUT-BEK | Exterior Heat-Zone brick extension kit | HTI 1 | \$ 73 | 8 | 21 | 21 | 14 | Y |
|--------------|--|-------|-------|---|----|----|----|---|

Venting Notes

Requires 8" DVP pipe. Must have a 18" minimum vertical vent before attaching a 90° elbow to unit. See Venting section.
 Approved for use with PVL-PSLP, PVI-SLP-B and PVV-SLP with power vent wire harness (order separately) and IFT-RC400 remote. See venting section of manual.

MEZZO 72

Includes:

- 30,000 - 58,000 Btu/Hour Input (NG)
- 24,000 - 46,000 Btu/Hour Input (LP)
- Clear LED dimmable lights
- Black glass refractory
- RC400 Remote Control
- Ceramic glass
- Junction box
- Gas flex connector
- Battery backup
- IntelliFire Touch ignition system



Special Considerations:

- If installing driftwood log set & river rock stones, only 1 stone set can be used
- If installing only river rock stones, 2 sets can be used

Required to Complete - Sold Separately: • Front • Crushed Glass Media

| | | Disc. Code | MSRP USD | 004 IA | 010 PA | 014 CA | 016 NC | EXP |
|-----------|---|------------|-----------|--------|--------|--------|--------|-----|
| MEZZO72-C | MEZZO 72 top direct vent fireplace with IntelliFire Touch Ignition (NG) | HNG 1 | \$ 11,179 | Y | 14 | Y | 14 | N |

Fronts - Non-Operable (Required to Complete)

Clean Face Trim

| | | | | | | | | |
|-------------|-----------------------------------|-------|----------|----|----|----|----|---|
| CFT-72-BK-C | Clean face trim - Black | HTI 1 | \$ 839 | Y | Y | Y | Y | Y |
| CFT-72-NB-C | Clean Face Trim - New Bronze | HTI 1 | \$ 899 | 14 | 14 | 14 | 14 | Y |
| CFT-72-GM-C | Clean face trim - Gun Metal | HTI 1 | \$ 899 | 14 | 14 | 14 | 14 | Y |
| CFT-72-SS-C | Clean face trim - Stainless Steel | HTI 1 | \$ 1,229 | 14 | 14 | 14 | 14 | Y |



Clean Face Trim

Media (Required to Complete)

Crushed Glass Media

| | | | | | | | | |
|-----------------|--|-------|--------|----|----|----|----|---|
| MEDIA-CLEAR-72 | Glass media, crystal (translucent white) | HTI 1 | \$ 479 | Y | Y | Y | 14 | Y |
| MEDIA-RED-72 | Glass media, scarlet (red) | HTI 1 | \$ 589 | 14 | 21 | 14 | 14 | Y |
| MEDIA-AMBER-72 | Glass media, amber | HTI 1 | \$ 589 | 14 | 21 | 14 | 14 | Y |
| MEDIA-COBALT-72 | Glass media, cobalt (blue) | HTI 1 | \$ 589 | 14 | 21 | 14 | 14 | Y |
| MEDIA-EBONY-72 | Glass media, ebony (black) | HTI 1 | \$ 589 | Y | 21 | Y | 14 | Y |
| MEDIA-FOG-72 | Iced fog media (requires black spray paint finish) | HNG 1 | \$ 589 | Y | 21 | 14 | 14 | Y |

MEDIA

| | | | | | | | | |
|-----------|---------------------------------------|-------|--------|----|----|----|----|---|
| STONES-72 | River Rock Stone Set (requires media) | HNG 1 | \$ 239 | 21 | 14 | 14 | 14 | Y |
|-----------|---------------------------------------|-------|--------|----|----|----|----|---|

Conversion Kit

Conversion Kit

| | | | | | | | | |
|----------|-------------------|-------|-------|----|----|----|----|---|
| LPK-8472 | LP conversion kit | HTI 1 | \$ 99 | Y | 21 | Y | 14 | Y |
| NGK-MC-C | NG Conversion Kit | HTI 1 | \$ 99 | 14 | 14 | 14 | 14 | Y |

| Gas Logs - Log Set Option | | | | | | | | | | |
|---------------------------------|---|-------|----|-------|----|----|----|----|---|--|
| Driftwood Log Set | | | | | | | | | | |
| DRIFTLOGS-72 | Driftwood Log Set (requires media) | HNG 1 | \$ | 779 | 14 | 14 | 14 | 14 | Y | |
| Natural Log Set | | | | | | | | | | |
| LOGS-72 | Natural Log Set (requires media) | HTI 1 | \$ | 659 | 14 | 14 | 14 | 14 | Y | |
| Heat Management | | | | | | | | | | |
| Heat Management | | | | | | | | | | |
| PH-SIDETRIM | Passive Heat trim kit for side discharge (includes 2 side registers)(Starting collars sold separately) | HTI 1 | \$ | 110 | Y | Y | Y | Y | Y | |
| PH-MCE | Starting Collars for Non-Ducted Passive Heat (Required when using passive heat - For use with Front, Side, Top Discharges) | HTI 1 | \$ | 179 | Y | Y | Y | Y | Y | |
| PH-FRTRIM-72 | Passive Heat Vent Trim Kit For Front Discharge (72")(Starting collars sold separately) | HTI 1 | \$ | 239 | Y | 14 | Y | 14 | Y | |
| Heat Management - Ducted | | | | | | | | | | |
| PHTRIM-MCE-72 | Ducted vent trim for front discharge using ducted Passive Heat (PHFR-MCE-72) | HTI 1 | \$ | 289 | 14 | 14 | 14 | 14 | Y | |
| PHFR-MCE-72 | Ducted Passive Heat kit for front discharge (requires PHTRIM-MCE-72 front trim) | HTI 1 | \$ | 809 | 14 | 14 | 14 | 14 | Y | |
| Heat Out Kit | | | | | | | | | | |
| HEAT-OUT-GAS | Heat out kit (includes termination cap, 25' of 6" round duct, fireplace adapter, damper, wall switch and 350CFM fan at termination) | HTI 1 | \$ | 1,529 | Y | 14 | Y | 14 | Y | |
| Heat Zone Kit | | | | | | | | | | |
| HZLIN-ADP | Heat Zone adaptor, must order for using HEAT-ZONE-GAS | HTI 1 | \$ | 179 | Y | Y | Y | 14 | Y | |
| HEAT-ZONE-GAS | Heat-Zone Kit includes fan, 20' of 6" round duct, vent, wall adapter & on/off control. Wire Plug Assembly 26D0619 required if controlling w/RC400 remote. Used in IFT units with ACM & not a GFK fan. Compatible for up to 2 HEAT-ZONE-GAS kits. See manual. | HTI 1 | \$ | 569 | Y | Y | Y | Y | Y | |
| Control, remotes, wall switches | | | | | | | | | | |
| Battery Back Up | | | | | | | | | | |
| BATTERY-WSK | Battery backup wall switch kit for units with IFT control systems. Includes: On/Off Wall Switch, USB-C Port, Battery Backup, Cover Plate, 12' Wire Harness | HTI 1 | \$ | 189 | Y | 14 | Y | 14 | Y | |
| IntelliFire app | | | | | | | | | | |
| IFT-WFM | IntelliFire Wi-Fi Module that works with the IntelliFire iOS and Android app. Use to control all the features of your fireplace via a smart device. An RC400, RC450 or RC150 is required for thermostat control | HTI 1 | \$ | 229 | Y | Y | Y | Y | Y | |
| Touch Screen Remote | | | | | | | | | | |
| IFT-RC400 | IntelliFire Touch black remote control, docking station and auxiliary control module (on/off, flame height, thermostat mode, fan control, child lock, cold climate, timer mode, hot indicator, lights, on-screen maintenance and troubleshooting notifications) | HTI 1 | \$ | 389 | Y | Y | Y | Y | Y | |
| Wall Switch | | | | | | | | | | |
| IFT-RC150-HNG | IntelliFire Touch white wireless wall switch (on/off, cold climate, battery strength indicator) | HNG 1 | \$ | 121 | Y | Y | Y | Y | Y | |



Battery Back Up



IntelliFire app

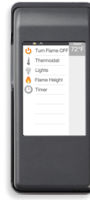

Touch Screen Remote



Wall Switch

Venting

Brick Extension Kit

| | | | | | | | | | |
|--------------|--|-------|----|----|---|----|----|----|---|
| HEAT-OUT-BEK | Exterior Heat-Zone brick extension kit | HTI 1 | \$ | 73 | 8 | 21 | 21 | 14 | Y |
|--------------|--|-------|----|----|---|----|----|----|---|

Venting Notes

Requires 8" DVP pipe. Must have a 30" minimum vertical before attaching a 90 degree elbow to unit. See venting section of manual.

Approved for use with PVLP-SLP, PVI-SLP-B and PVV-SLP with power vent wire harness (order separately) and IFT-RC400 remote. See venting section of manual.

Primo II 48

Includes:

- 45,000 - 31,500 BTU/Hour Input (NG)
- 45,000 - 31,500 BTU/Hour Input (LP)
- 48" W x 18" H Glass Viewing Size
- Intellifire Touch 2.0 Ignition System
- RC-450 Remote Control
- Multi-Colored LED Lights
- 6" Outside Air Starting Collar & Exterior Hood (6" Insulated Flex Sold Separately)
- Suction Cups Recommended (Not Included) to Install and Remove Safe Surface & Firebox Glass
- Advanced Technology Product Training Required Before Product Ships



Special Considerations:

- Crushed Glass Media Only (Not Included): 4 Bags
- Crushed Glass Media With Logs (Not Included): 3 Bags
- Stones (Not Included): use only 1 set, requires media, cannot be used with logs
- When Terminating Horizontal The HZTERM-ADP Kit Is Required Along With a Standard Trap Cap

Required to Complete - Sold Separately:

- Safe Surface Glass (QTY 1)
- Liner Kit
- Crushed Glass Media
- 6" Insulated Flex Duct

| | | Disc. Code | MSRP USD | 004 IA | 010 PA | 014 CA | 016 NC | EXP |
|-------------|--|------------|----------|--------|--------|--------|--------|-----|
| PRIMO-II-48 | 48" Single Side Direct Vent Gas Fireplace Top Vent With IntelliFire Touch 2.0 Ignition System (NG) | HNG 1 | \$ 8,109 | Y | 14 | Y | 14 | N |

Fronts - Non-Operable (Required to Complete)

Safe Surface Glass

| | | | | | | | | |
|-------------|-------------------------------|-------|--------|---|----|---|----|---|
| GLASS-SS-48 | 48" SafeSurface Barrier Glass | HNG 1 | \$ 419 | Y | 14 | Y | 14 | Y |
|-------------|-------------------------------|-------|--------|---|----|---|----|---|



Safe Surface Glass

Media (Required to Complete)

Crushed Glass Media

| | | | | | | | | |
|----------|---|-------|-------|---|---|---|---|---|
| MEDIA-CP | Copper Embers - Crushed Glass Media (1 bag, 5lbs) | HTI 1 | \$ 77 | Y | Y | Y | Y | Y |
| MEDIA-CY | Crystal Embers - Crushed Glass Media (1 bag, 5lbs) | HTI 1 | \$ 77 | Y | Y | Y | Y | Y |
| MEDIA-GT | Graphite Embers - Crushed Glass Media (1 bag, 5lbs) | HTI 1 | \$ 77 | Y | Y | Y | Y | Y |
| MEDIA-SM | Smoked Embers - Crushed Glass Media (1 bag, 5lbs) | HTI 1 | \$ 77 | Y | Y | Y | Y | Y |

MEDIA

| | | | | | | | | |
|-----------|---------------------------------------|-------|--------|---|----|---|----|---|
| STONES-48 | River Rock Stone Set (requires media) | HNG 1 | \$ 169 | Y | 14 | Y | 14 | Y |
|-----------|---------------------------------------|-------|--------|---|----|---|----|---|

| Liner Kit (Required to Complete) | | | | | | | | | | |
|---|---|-------|----|-----|----|----|----|----|----|---|
| Architectural Fiber Refractory | | | | | | | | | | |
| ACT-PR-48 | 48" Architectural Fiber Refractory | HNG 1 | \$ | 699 | 56 | 63 | 63 | 63 | 63 | Y |
| Black Glass Liner - Fluted | | | | | | | | | | |
| BGK-FL-PR-48 | 48" Black Glass Liner - Fluted | HNG 1 | \$ | 929 | Y | 14 | 14 | 14 | 14 | Y |
| Black Glass Liner - Marbled | | | | | | | | | | |
| BGK-MAR-PR-48 | 48" Black Glass Liner - Marbled | HNG 1 | \$ | 929 | Y | 42 | 42 | 42 | 42 | Y |
| Black Glass Liner - Reflective | | | | | | | | | | |
| BGK-PR-48 | 48" Black Glass Liner - Reflective | HNG 1 | \$ | 929 | Y | 63 | Y | 63 | Y | Y |
| Column Fiber Refractory | | | | | | | | | | |
| COL-PR-48 | 48" Stone Column Fiber Refractory | HNG 1 | \$ | 699 | Y | 14 | 14 | 14 | 14 | Y |
| Venting (Required to Complete) | | | | | | | | | | |
| Insulated Flex Duct - Chimney Air Kits/Flex Duct | | | | | | | | | | |
| ID6 | 6" (152mm) insulated flex duct for use with outside air kit - includes two 42" (1065mm) sections | HTI 1 | \$ | 100 | Y | Y | Y | Y | Y | Y |
| 6" Insulated Flex Duct | | | | | | | | | | |
| FLEXDUCT6AI | 6" (152mm) insulated flex duct for outside air - 25' | HTI 1 | \$ | 100 | Y | Y | Y | Y | Y | Y |
| LP Conversion Kit | | | | | | | | | | |
| LP Conversion Kit | | | | | | | | | | |
| LPK-PRIMOII | LP Conversion Kit for Primo II Series | HNG 1 | \$ | 99 | Y | Y | Y | Y | Y | Y |
| Gas Logs - Log Set Option | | | | | | | | | | |
| Birch Logs | | | | | | | | | | |
| BIRLG-LIN-SM | 48" Birch Log Set (Requires Crushed Glass Media) | HNG 1 | \$ | 549 | Y | 14 | 14 | 14 | 14 | Y |
| Driftwood Logs | | | | | | | | | | |
| DWLG-LIN-SM | 48" Driftwood Log Set (Requires Crushed Glass Media) | HTI 1 | \$ | 549 | | 28 | 28 | 28 | 28 | Y |
| Traditional Logs | | | | | | | | | | |
| OAKLG-LIN-SM | 48" Traditional Log Set (Requires Crushed Glass Media) | HTI 1 | \$ | 549 | 21 | 14 | 14 | 14 | 14 | Y |
| Options & Accessories | | | | | | | | | | |
| Carry Handle | | | | | | | | | | |
| CARRY-HANDLE | Reusable Carry Handle for use with PRIMO-II (1 pcs, need 2 per unit) | HTI 1 | \$ | 179 | 14 | 14 | 14 | 14 | 14 | Y |
| Heat Management | | | | | | | | | | |
| Primo Heat Duct | | | | | | | | | | |
| PRIMO-HEAT-DUCT | Heat Zone Duct Kit - Includes Unit Collar, 10" x 4" x 6" 90 Degree Register Duct Boot, 10" x 4" White Sidewall and Ceiling Register, 25' of 6" Insulated Flex Duct | HNG 1 | \$ | 169 | Y | 14 | Y | 14 | Y | Y |
| Control, remotes, wall switches | | | | | | | | | | |
| IntelliFire app | | | | | | | | | | |
| IFT-WFM | IntelliFire Wi-Fi Module that works with the IntelliFire iOS and Android app. Use to control all the features of your fireplace via a smart device. An RC400, RC450 or RC150 is required for thermostat control | HTI 1 | \$ | 229 | Y | Y | Y | Y | Y | Y |

IntelliFire Touch Controls - Aux Module

| | | | | | | | | |
|-----------|---|--------|-------|----|----|----|----|---|
| IFT2-PACM | IntelliFire Touch 2.0 Premium AUX Module. Controls Lights, Fans, Power Vents, HTI 1 or Heat Management. Does not include RC450 Touchscreen remote | \$ 144 | HTI 1 | 14 | 14 | 14 | 14 | Y |
|-----------|---|--------|-------|----|----|----|----|---|

Touch Screen Remote

| | | | | | | | | |
|------------|--|--------|-------|----|----|----|----|---|
| IFT2-RC450 | IntelliFire Touch 2.0 touchscreen remote and docking station. Controls flame On/Off, Lights, Fans, Heat Management, Timer, Thermostat, Flame Height, On-screen maintenance and troubleshooting notifications (IFT2-PACM sold separately) | \$ 259 | HTI 1 | 14 | 14 | 14 | 14 | Y |
|------------|--|--------|-------|----|----|----|----|---|

Wall Switch

| | | | | | | | | |
|------------|---|--------|-------|----|----|----|----|---|
| IFT-RC150U | Universally compatible with IntelliFire Touch and IntelliFire Touch 2.0 systems. White wireless wall switch for On/Off and Cold Climate control | \$ 121 | HTI 1 | 14 | 14 | 14 | 14 | Y |
|------------|---|--------|-------|----|----|----|----|---|



IntelliFire app

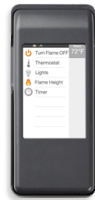

Touch Screen Remote



Wall Switch

Termination Kits

Horizontal Termination Kit

| | | | | | | | | |
|------------|---|--------|-------|---|---|---|---|---|
| HZTERM-ADP | Horizontal Termination Adaptor Kit - Includes Base and Face Trim (Required For All Horizontal Terminations, To Be Used With Standard DVP and SLP Trap Caps) | \$ 169 | HNG 1 | Y | Y | Y | Y | Y |
|------------|---|--------|-------|---|---|---|---|---|

Venting Notes

| |
|---|
| DVP and SLP Venting Approved (DVP Starting Collar) |
| See Venting Section In Install Manual For Approved Pipe and Termination Caps |
| 6" Insulated Flex Duct For Outside Air |
| When Terminating Horizontal the HZTERM-ADP Kit Is Required Along With a Standard Trap Cap |

Primo II 60

Includes:

- 55,000 - 38,500 BTU/Hour Input (NG)
- 55,000 - 38,500 BTU/Hour Input (LP)
- 60" W x 18" H Glass Viewing Size
- Intellifire Touch 2.0 Ignition System
- RC-450 Remote Control
- Multi-Colored LED Lights
- 6" Outside Air Starting Collar & Exterior Hood (6" Insulated Flex Sold Separately)
- Suction Cups Recommended (Not Included) to Install and Remove Safe Surface & Firebox Glass
- Advanced Technology Product Training Required Before Product Ships



Special Considerations:

- Crushed Glass Media Only (Not Included): 4 Bags
- Crushed Glass Media With Logs (Not Included): 3 Bags
- Stones (Not Included): use only 1 set, requires media, cannot be used with logs
- When Terminating Horizontal The HZTERM-ADP Kit Is Required Along With a Standard Trap Cap

Required to Complete - Sold Separately:

- Safe Surface Glass (QTY 1)
- Crushed Glass Media
- Liner Kit
- 6" Insulated Flex Duct

| | | Disc. Code | MSRP USD | 004 IA | 010 PA | 014 CA | 016 NC | EXP |
|-------------|--|------------|-----------|--------|--------|--------|--------|-----|
| PRIMO-II-60 | 60" Single Side Direct Vent Gas Fireplace Top Vent With IntelliFire Touch 2.0 Ignition System (NG) | HNG 1 | \$ 10,709 | Y | Y | Y | Y | N |

Fronts - Non-Operable (Required to Complete)

Safe Surface Glass

| | | | | | | | | |
|-------------|-------------------------------|-------|--------|---|---|---|---|---|
| GLASS-SS-60 | 60" SafeSurface Barrier Glass | HNG 1 | \$ 469 | Y | Y | Y | Y | Y |
|-------------|-------------------------------|-------|--------|---|---|---|---|---|



Safe Surface Glass

Media (Required to Complete)

Crushed Glass Media

| | | | | | | | | |
|----------|---|-------|-------|---|---|---|---|---|
| MEDIA-CP | Copper Embers - Crushed Glass Media (1 bag, 5lbs) | HTI 1 | \$ 77 | Y | Y | Y | Y | Y |
| MEDIA-CY | Crystal Embers - Crushed Glass Media (1 bag, 5lbs) | HTI 1 | \$ 77 | Y | Y | Y | Y | Y |
| MEDIA-GT | Graphite Embers - Crushed Glass Media (1 bag, 5lbs) | HTI 1 | \$ 77 | Y | Y | Y | Y | Y |
| MEDIA-SM | Smoked Embers - Crushed Glass Media (1 bag, 5lbs) | HTI 1 | \$ 77 | Y | Y | Y | Y | Y |

MEDIA

| | | | | | | | | |
|-----------|---------------------------------------|-------|--------|---|----|----|----|---|
| STONES-60 | River Rock Stone Set (requires media) | HNG 1 | \$ 209 | Y | 14 | 14 | 14 | Y |
|-----------|---------------------------------------|-------|--------|---|----|----|----|---|

| Liner Kit (Required to Complete) | | | | | | | | | | |
|---|---|-------|----|-------|----|----|----|----|---|--|
| Architectural Fiber Refractory | | | | | | | | | | |
| ACT-PR-60 | 60" Architectural Fiber Refractory | HNG 1 | \$ | 799 | Y | 14 | 14 | 14 | Y | |
| Black Glass Liner - Fluted | | | | | | | | | | |
| BGK-FL-PR-60 | 60" Black Glass Liner - Fluted | HNG 1 | \$ | 1,039 | Y | 14 | 14 | Y | Y | |
| Black Glass Liner - Marbled | | | | | | | | | | |
| BGK-MAR-PR-60 | 60" Black Glass Liner - Marbled | HNG 1 | \$ | 1,039 | Y | 14 | 14 | 14 | Y | |
| Black Glass Liner - Reflective | | | | | | | | | | |
| BGK-PR-60 | 60" Black Glass Liner - Reflective | HNG 1 | \$ | 1,039 | Y | 14 | Y | 14 | Y | |
| Column Fiber Refractory | | | | | | | | | | |
| COL-PR-60 | 60" Stone Column Fiber Refractory | HNG 1 | \$ | 799 | Y | 14 | 14 | 14 | Y | |
| Venting (Required to Complete) | | | | | | | | | | |
| Insulated Flex Duct - Chimney Air Kits/Flex Duct | | | | | | | | | | |
| ID6 | 6" (152mm) insulated flex duct for use with outside air kit - includes two 42" (1065mm) sections | HTI 1 | \$ | 100 | Y | Y | Y | Y | Y | |
| 6" Insulated Flex Duct | | | | | | | | | | |
| FLEXDUCT6AI | 6" (152mm) insulated flex duct for outside air - 25' | HTI 1 | \$ | 100 | Y | Y | Y | Y | Y | |
| LP Conversion Kit | | | | | | | | | | |
| LP Conversion Kit | | | | | | | | | | |
| LPK-PRIMOII | LP Conversion Kit for Primo II Series | HNG 1 | \$ | 99 | Y | Y | Y | Y | Y | |
| Gas Logs - Log Set Option | | | | | | | | | | |
| Birch Logs | | | | | | | | | | |
| BIRLG-LIN-LG | 60" & 72" Birch Log Set (Requires Crushed Glass Media) | HNG 1 | \$ | 649 | Y | 14 | 14 | 14 | Y | |
| Driftwood Logs | | | | | | | | | | |
| DWLG-LIN-LG | 60" & 72" Driftwood Log Set (Requires Crushed Glass Media) | HTI 1 | \$ | 649 | Y | 14 | 21 | 14 | Y | |
| Traditional Logs | | | | | | | | | | |
| OAKLG-LIN-LG | 60" & 72" Traditional Log Set (Requires Crushed Glass Media) | HTI 1 | \$ | 649 | 21 | 14 | 14 | 14 | Y | |
| Options & Accessories | | | | | | | | | | |
| Carry Handle | | | | | | | | | | |
| CARRY-HANDLE | Reusable Carry Handle for use with PRIMO-II (1 pcs, need 2 per unit) | HTI 1 | \$ | 179 | 14 | 14 | 14 | 14 | Y | |
| Heat Management | | | | | | | | | | |
| Primo Heat Duct | | | | | | | | | | |
| PRIMO-HEAT-DUCT | Heat Zone Duct Kit - Includes Unit Collar, 10" x 4" x 6" 90 Degree Register Duct Boot, 10" x 4" White Sidewall and Ceiling Register, 25' of 6" Insulated Flex Duct | HNG 1 | \$ | 169 | Y | 14 | Y | 14 | Y | |
| Control, remotes, wall switches | | | | | | | | | | |
| IntelliFire app | | | | | | | | | | |
| IFT-WFM | IntelliFire Wi-Fi Module that works with the IntelliFire iOS and Android app. Use to control all the features of your fireplace via a smart device. An RC400, RC450 or RC150 is required for thermostat control | HTI 1 | \$ | 229 | Y | Y | Y | Y | Y | |

| IntelliFire Touch Controls - Aux Module | | | | | | | | | |
|---|--|-------|-----|-----|----|----|----|----|---|
| IFT2-PACM | IntelliFire Touch 2.0 Premium AUX Module. Controls Lights, Fans, Power Vents, HTI 1 or Heat Management. Does not include RC450 Touchscreen remote | \$ | 144 | 14 | 14 | 14 | 14 | Y | |
| Touch Screen Remote | | | | | | | | | |
| IFT2-RC450 | IntelliFire Touch 2.0 touchscreen remote and docking station. Controls flame On/Off, Lights, Fans, Heat Management, Timer, Thermostat, Flame Height, On-screen maintenance and troubleshooting notifications (IFT2-PACM sold separately) | HTI 1 | \$ | 259 | 14 | 14 | 14 | 14 | Y |
| Wall Switch | | | | | | | | | |
| IFT-RC150U | Universally compatible with IntelliFire Touch and IntelliFire Touch 2.0 systems. White wireless wall switch for On/Off and Cold Climate control | HTI 1 | \$ | 121 | 14 | 14 | 14 | 14 | Y |



IntelliFire app

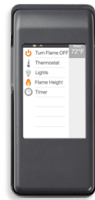

Touch Screen Remote



Wall Switch

Termination Kits

| Horizontal Termination Kit | | | | | | | | | |
|----------------------------|---|-------|----|-----|---|---|---|---|---|
| HZTERM-ADP | Horizontal Termination Adaptor Kit - Includes Base and Face Trim (Required For All Horizontal Terminations, To Be Used With Standard DVP and SLP Trap Caps) | HNG 1 | \$ | 169 | Y | Y | Y | Y | Y |

Venting Notes

| |
|---|
| DVP and SLP Venting Approved (DVP Starting Collar) |
| See Venting Section In Install Manual For Approved Pipe and Termination Caps |
| 6" Insulated Flex Duct For Outside Air |
| When Terminating Horizontal the HZTERM-ADP Kit Is Required Along With a Standard Trap Cap |

Primo II 72

Includes:

- 59,000 - 38,500 BTU/Hour Input (NG)
- 59,000 - 38,500 BTU/Hour Input (LP)
- 72" W x 18" H Glass Viewing Size
- Intellifire Touch 2.0 Ignition System
- RC-450 Remote Control
- Multi-Colored LED Lights
- 6" Outside Air Starting Collar & Exterior Hood (6" Insulated Flex Sold Separately)
- Suction Cups Recommended (Not Included) to Install and Remove Safe Surface & Firebox Glass
- Advanced Technology Product Training Required Before Product Ships



Special Considerations:

- Crushed Glass Media Only (Not Included): 5 Bags
- Crushed Glass Media With Logs (Not Included): 4 Bags
- Stones (Not Included): use only 1 set, requires media, cannot be used with logs
- When Terminating Horizontal The HZTERM-ADP Kit Is Required Along With a Standard Trap Cap

Required to Complete - Sold Separately:

- Safe Surface Glass (QTY 1)
- Crushed Glass Media
- Liner Kit
- 6" Insulated Flex Duct

| | | Disc. Code | MSRP USD | 004 IA | 010 PA | 014 CA | 016 NC | EXP |
|-------------|--|------------|-----------|--------|--------|--------|--------|-----|
| PRIMO-II-72 | 72" Single Side Direct Vent Gas Fireplace Top Vent With IntelliFire Touch 2.0 Ignition System (NG) | HNG 1 | \$ 13,469 | Y | 14 | Y | 14 | N |

Fronts - Non-Operable (Required to Complete)

Safe Surface Glass

| | | | | | | | | |
|-------------|-------------------------------|-------|--------|---|----|---|----|---|
| GLASS-SS-72 | 72" SafeSurface Barrier Glass | HNG 1 | \$ 529 | Y | 14 | Y | 14 | Y |
|-------------|-------------------------------|-------|--------|---|----|---|----|---|



Safe Surface Glass

Media (Required to Complete)

Crushed Glass Media

| | | | | | | | | |
|----------|---|-------|-------|---|---|---|---|---|
| MEDIA-CP | Copper Embers - Crushed Glass Media (1 bag, 5lbs) | HTI 1 | \$ 77 | Y | Y | Y | Y | Y |
| MEDIA-CY | Crystal Embers - Crushed Glass Media (1 bag, 5lbs) | HTI 1 | \$ 77 | Y | Y | Y | Y | Y |
| MEDIA-GT | Graphite Embers - Crushed Glass Media (1 bag, 5lbs) | HTI 1 | \$ 77 | Y | Y | Y | Y | Y |
| MEDIA-SM | Smoked Embers - Crushed Glass Media (1 bag, 5lbs) | HTI 1 | \$ 77 | Y | Y | Y | Y | Y |

MEDIA

| | | | | | | | | |
|-----------|---------------------------------------|-------|--------|----|----|----|----|---|
| STONES-72 | River Rock Stone Set (requires media) | HNG 1 | \$ 239 | 21 | 14 | 14 | 14 | Y |
|-----------|---------------------------------------|-------|--------|----|----|----|----|---|

| Liner Kit (Required to Complete) | | | | | | | | | | |
|---|---|-------|----|-------|----|----|----|----|----|---|
| Architectural Fiber Refractory | | | | | | | | | | |
| ACT-PR-72 | 72" Architectural Fiber Refractory | HNG 1 | \$ | 899 | Y | 14 | 14 | 14 | 14 | Y |
| Black Glass Liner - Fluted | | | | | | | | | | |
| BGK-FL-PR-72 | 72" Black Glass Liner - Fluted | HNG 1 | \$ | 1,149 | Y | 14 | 14 | 14 | 14 | Y |
| Black Glass Liner - Marbled | | | | | | | | | | |
| BGK-MAR-PR-72 | 72" Black Glass Liner - Marbled | HNG 1 | \$ | 1,149 | Y | 42 | 42 | 42 | 42 | Y |
| Black Glass Liner - Reflective | | | | | | | | | | |
| BGK-PR-72 | 72" Black Glass Liner - Reflective | HNG 1 | \$ | 1,149 | Y | 14 | Y | 14 | Y | Y |
| Column Fiber Refractory | | | | | | | | | | |
| COL-PR-72 | 72" Stone Column Fiber Refractory | HNG 1 | \$ | 899 | Y | 14 | 14 | 14 | 14 | Y |
| Venting (Required to Complete) | | | | | | | | | | |
| Insulated Flex Duct - Chimney Air Kits/Flex Duct | | | | | | | | | | |
| ID6 | 6" (152mm) insulated flex duct for use with outside air kit - includes two 42" (1065mm) sections | HTI 1 | \$ | 100 | Y | Y | Y | Y | Y | Y |
| 6" Insulated Flex Duct | | | | | | | | | | |
| FLEXDUCT6AI | 6" (152mm) insulated flex duct for outside air - 25' | HTI 1 | \$ | 100 | Y | Y | Y | Y | Y | Y |
| LP Conversion Kit | | | | | | | | | | |
| LP Conversion Kit | | | | | | | | | | |
| LPK-PRIMOII | LP Conversion Kit for Primo II Series | HNG 1 | \$ | 99 | Y | Y | Y | Y | Y | Y |
| Gas Logs - Log Set Option | | | | | | | | | | |
| Birch Logs | | | | | | | | | | |
| BIRLG-LIN-LG | 60" & 72" Birch Log Set (Requires Crushed Glass Media) | HNG 1 | \$ | 649 | Y | 14 | 14 | 14 | 14 | Y |
| Driftwood Logs | | | | | | | | | | |
| DWLG-LIN-LG | 60" & 72" Driftwood Log Set (Requires Crushed Glass Media) | HTI 1 | \$ | 649 | Y | 14 | 21 | 14 | 14 | Y |
| Traditional Logs | | | | | | | | | | |
| OAKLG-LIN-LG | 60" & 72" Traditional Log Set (Requires Crushed Glass Media) | HTI 1 | \$ | 649 | 21 | 14 | 14 | 14 | 14 | Y |
| Options & Accessories | | | | | | | | | | |
| Carry Handle | | | | | | | | | | |
| CARRY-HANDLE | Reusable Carry Handle for use with PRIMO-II (1 pcs, need 2 per unit) | HTI 1 | \$ | 179 | 14 | 14 | 14 | 14 | 14 | Y |
| Heat Management | | | | | | | | | | |
| Primo Heat Duct | | | | | | | | | | |
| PRIMO-HEAT-DUCT | Heat Zone Duct Kit - Includes Unit Collar, 10" x 4" x 6" 90 Degree Register Duct Boot, 10" x 4" White Sidewall and Ceiling Register, 25' of 6" Insulated Flex Duct | HNG 1 | \$ | 169 | Y | 14 | Y | 14 | Y | Y |
| Control, remotes, wall switches | | | | | | | | | | |
| IntelliFire app | | | | | | | | | | |
| IFT-WFM | IntelliFire Wi-Fi Module that works with the IntelliFire iOS and Android app. Use to control all the features of your fireplace via a smart device. An RC400, RC450 or RC150 is required for thermostat control | HTI 1 | \$ | 229 | Y | Y | Y | Y | Y | Y |

IntelliFire Touch Controls - Aux Module

| | | | | | | | | |
|-----------|---|--------|-------|----|----|----|----|---|
| IFT2-PACM | IntelliFire Touch 2.0 Premium AUX Module. Controls Lights, Fans, Power Vents, HTI 1 or Heat Management. Does not include RC450 Touchscreen remote | \$ 144 | HTI 1 | 14 | 14 | 14 | 14 | Y |
|-----------|---|--------|-------|----|----|----|----|---|

Touch Screen Remote

| | | | | | | | | |
|------------|--|--------|-------|----|----|----|----|---|
| IFT2-RC450 | IntelliFire Touch 2.0 touchscreen remote and docking station. Controls flame On/Off, Lights, Fans, Heat Management, Timer, Thermostat, Flame Height, On-screen maintenance and troubleshooting notifications (IFT2-PACM sold separately) | \$ 259 | HTI 1 | 14 | 14 | 14 | 14 | Y |
|------------|--|--------|-------|----|----|----|----|---|

Wall Switch

| | | | | | | | | |
|------------|---|--------|-------|----|----|----|----|---|
| IFT-RC150U | Universally compatible with IntelliFire Touch and IntelliFire Touch 2.0 systems. White wireless wall switch for On/Off and Cold Climate control | \$ 121 | HTI 1 | 14 | 14 | 14 | 14 | Y |
|------------|---|--------|-------|----|----|----|----|---|



IntelliFire app

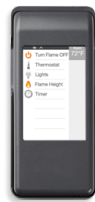

Touch Screen Remote



Wall Switch

Termination Kits

Horizontal Termination Kit

| | | | | | | | | |
|------------|---|--------|-------|---|---|---|---|---|
| HZTERM-ADP | Horizontal Termination Adaptor Kit - Includes Base and Face Trim (Required For All Horizontal Terminations, To Be Used With Standard DVP and SLP Trap Caps) | \$ 169 | HNG 1 | Y | Y | Y | Y | Y |
|------------|---|--------|-------|---|---|---|---|---|

Venting Notes

| |
|---|
| DVP and SLP Venting Approved (DVP Starting Collar) |
| See Venting Section In Install Manual For Approved Pipe and Termination Caps |
| 6" Insulated Flex Duct For Outside Air |
| When Terminating Horizontal the HZTERM-ADP Kit Is Required Along With a Standard Trap Cap |

SlimLine 3X

Includes:

- 11,500 - 21,000 Btu/Hour Input (NG)
- Five HD ceramic logs
- Ceramic glass
- Ceramic brick refractory
- LED Illuminated embers
- RC400 touchscreen remote
- GFK-160A variable speed blower
- External air shutter adjustment
- Battery backup
- Junction box
- Gas flex connector
- Glowing embers
- 4" x 6-5/8" top vent collar
- 5" x 8" rear vent collar
- IntelliFire Touch ignition system



Required to Complete - Sold Separately: • Front

| | | Disc. Code | MSRP USD | 004 IA | 010 PA | 014 CA | 016 NC | EXP |
|--------------|--|------------|----------|--------|--------|--------|--------|-----|
| SL-3X-IFT-S | SL-3X 28" Direct Vent gas fireplace top/rear vent with IntelliFire Touch and Stratford refractory (NG) | HNG 1 | \$ 3,079 | Y | Y | Y | 14 | N |
| SL-3X-IFT-TG | SL-3X 28" Direct Vent gas fireplace top/rear vent with IntelliFire Touch and Tranquil Greige refractory (NG) | HNG 1 | \$ 3,139 | 14 | 14 | 14 | 14 | N |
| SL-3X-IFT-G | SL-3X 28" Direct Vent gas fireplace top/rear vent with IntelliFire Touch and black glass refractory (NG) | HNG 1 | \$ 3,489 | Y | 14 | 14 | 14 | N |

Fronts - Non-Operable (Required to Complete)

Firescreen

| | | | | | | | | |
|---------|------------------------------------|-------|--------|---|---|---|----|---|
| FS-3-BK | Firescreen inside fit front- Black | HNG 1 | \$ 269 | Y | Y | Y | 14 | Y |
|---------|------------------------------------|-------|--------|---|---|---|----|---|

Halston

| | | | | | | | | |
|-----------|--|-------|--------|----|----|----|----|---|
| HAL-28-BK | Halston overlap fixed front - Black | HNG 1 | \$ 789 | 14 | 14 | 14 | 14 | Y |
| HAL-28-NB | Halston overlap fixed front - New Bronze | HNG 1 | \$ 829 | 14 | 14 | 14 | 14 | Y |
| HAL-28-GM | Halston overlap fixed front - Gun Metal | HNG 1 | \$ 829 | 14 | 14 | 14 | 14 | Y |

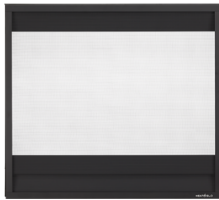

Firescreen

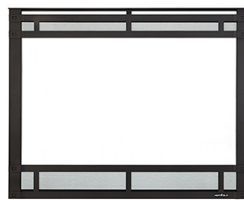

Halston

Conversion Kit

Conversion Kit

| | | | | | | | | |
|----------|-------------------------|-------|-------|---|---|---|----|---|
| LPK-SL3X | NG to LP conversion kit | HNG 1 | \$ 99 | Y | Y | Y | 14 | Y |
|----------|-------------------------|-------|-------|---|---|---|----|---|

Refractory

Glass Refractory SL

| | | | | | | | | |
|----------|-----------------------------------|-------|--------|----|----|----|----|---|
| GLASS-3X | Reflective black glass refractory | HNG 1 | \$ 609 | 14 | 21 | 14 | 14 | Y |
|----------|-----------------------------------|-------|--------|----|----|----|----|---|

Fans

Fan

| | | | | | | | | |
|----------|--|-------|--------|---|---|---|---|---|
| GFK-160C | Fan kit 160 CFM (fan only) | HTI 1 | \$ 259 | Y | Y | Y | Y | Y |
| GFK-160A | Fan kit 160 CFM (includes rheostat and temperature sensor) | HTI 1 | \$ 319 | Y | Y | Y | Y | Y |

Heat Management

Heat Out Kit

| | | | | | | | | |
|--------------|---|-------|----------|---|----|---|----|---|
| HEAT-OUT-GAS | Heat out kit (includes termination cap, 25' of 6" round duct, fireplace adapter, damper, wall switch and 350CFM fan at termination) | HTI 1 | \$ 1,529 | Y | 14 | Y | 14 | Y |
|--------------|---|-------|----------|---|----|---|----|---|

Heat Zone Kit

| | | | | | | | | |
|---------------|--|-------|--------|---|---|---|---|---|
| HEAT-ZONE-GAS | Heat-Zone Kit includes fan, 20' of 6" round duct, vent, wall adapter & on/off control. Wire Plug Assembly 26D0619 required if controlling w/RC400 remote. Used in IFT units with ACM & not a GFK fan. Compatible for up to 2 HEAT-ZONE-GAS kits. See manual. | HTI 1 | \$ 569 | Y | Y | Y | Y | Y |
|---------------|--|-------|--------|---|---|---|---|---|

Control, remotes, wall switches

Battery Back Up

| | | | | | | | | |
|-------------|--|-------|--------|---|----|---|----|---|
| BATTERY-WSK | Battery backup wall switch kit for units with IFT control systems. Includes: On/Off Wall Switch, USB-C Port, Battery Backup, Cover Plate, 12' Wire Harness | HTI 1 | \$ 189 | Y | 14 | Y | 14 | Y |
|-------------|--|-------|--------|---|----|---|----|---|

IntelliFire app

| | | | | | | | | |
|---------|---|-------|--------|---|---|---|---|---|
| IFT-WFM | IntelliFire Wi-Fi Module that works with the IntelliFire iOS and Android app. Use to control all the features of your fireplace via a smart device. An RC400, RC450 or RC150 is required for thermostat control | HTI 1 | \$ 229 | Y | Y | Y | Y | Y |
|---------|---|-------|--------|---|---|---|---|---|

Touch Screen Remote

| | | | | | | | | |
|-----------|---|-------|--------|---|---|---|---|---|
| IFT-RC400 | IntelliFire Touch black remote control, docking station and auxiliary control module (on/off, flame height, thermostat mode, fan control, child lock, cold climate, timer mode, hot indicator, lights, on-screen maintenance and troubleshooting notifications) | HTI 1 | \$ 389 | Y | Y | Y | Y | Y |
|-----------|---|-------|--------|---|---|---|---|---|

Wall Switch

| | | | | | | | | |
|---------------|---|-------|--------|---|---|---|---|---|
| IFT-RC150-HNG | IntelliFire Touch white wireless wall switch (on/off, cold climate, battery strength indicator) | HNG 1 | \$ 121 | Y | Y | Y | Y | Y |
|---------------|---|-------|--------|---|---|---|---|---|



Battery Back Up



IntelliFire app

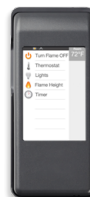

Touch Screen Remote



Wall Switch

Venting

Brick Extension Kit

| | | | | | | | | |
|--------------|--|-------|-------|---|----|----|----|---|
| HEAT-OUT-BEK | Exterior Heat-Zone brick extension kit | HTI 1 | \$ 73 | 8 | 21 | 21 | 14 | Y |
|--------------|--|-------|-------|---|----|----|----|---|

Venting Notes

Requires SLP series or SLP-Flex series pipe when venting off top of unit. See Venting section.
 Requires DVP series pipe when venting off rear of unit. See Venting section.
 Approved for use with PVL-PSL, PVI-SLP-B and PVV-SLP with power vent wire harness (order separately) and IFT-RC400 remote. See venting section of manual.

SlimLine 5 w/ IFT

Includes:

- 14,900 - 21,000 Btu/Hour Input (NG)
- 14,000 - 18,500 Btu/Hour Input (LP)
- Five Ceramic logs
- Tempered glass
- Glowing embers
- External air shutter adjustment
- 12' control wire
- Battery backup
- Manual gas shut-off valve
- Junction box
- Gas flex connector
- 4" x 6-5/8" top vent collar
- 5" x 8" rear vent collar
- IntelliFire Touch ignition system
- Optional Wi-Fi with Intellifire App



Required to Complete - Sold Separately: • Front

| | | Disc. Code | MSRP USD | 004 IA | 010 PA | 014 CA | 016 NC | EXP |
|------------|---|------------|----------|--------|--------|--------|--------|-----|
| SL-5-IFT | SL-5 32" Direct Vent Gas Fireplace top/rear with IntelliFire Touch (NG) | HNG 1 | \$ 2,049 | Y | Y | Y | Y | N |
| SL-5LP-IFT | SL-5 32" Direct Vent Gas Fireplace top/rear with IntelliFire Touch (LP) | HNG 1 | \$ 2,119 | Y | Y | 14 | 14 | N |

Fronts - Non-Operable (Required to Complete)

Arcadia

| | | | | | | | | |
|-----------|---|-------|--------|----|----|----|----|---|
| ARC-32-BK | Arcadia overlap arched front - Black | HNG 1 | \$ 679 | Y | 14 | 14 | 14 | Y |
| ARC-32-NB | Arcadia overlap arched front - New Bronze | HNG 1 | \$ 719 | 14 | 14 | 14 | 21 | Y |
| ARC-32-GM | Arcadia overlap arched front - Gun Metal | HNG 1 | \$ 719 | 14 | 14 | 14 | 14 | Y |

Chateau Forge

| | | | | | | | | |
|---------|----------------------------------|-------|----------|---|----|----|----|---|
| CHAF-32 | Chateau Forge hand-crafted front | HNG 1 | \$ 1,989 | Y | 14 | 14 | 14 | Y |
|---------|----------------------------------|-------|----------|---|----|----|----|---|

Clean Face Kit

| | | | | | | | | |
|----------|--|-------|--------|----|----|----|----|---|
| CF-32-BK | Clean Face kit- includes upper and lower solid louvers and clean face front - Black | HNG 1 | \$ 499 | Y | Y | Y | 14 | Y |
| CF-32-GM | Clean Face kit - includes upper and lower solid louvers and clean face front - Gun Metal | HNG 1 | \$ 549 | 14 | 14 | 14 | 14 | Y |
| CF-32-NB | Clean Face kit- includes upper and lower solid louvers and clean face front - New Bronze | HNG 1 | \$ 549 | 14 | 14 | 14 | 14 | Y |

Firescreen

| | | | | | | | | |
|---------|------------------------------------|-------|--------|---|---|---|---|---|
| FS-5-BK | Firescreen inside fit front- Black | HNG 1 | \$ 289 | Y | Y | Y | Y | Y |
|---------|------------------------------------|-------|--------|---|---|---|---|---|

Halston

| | | | | | | | | |
|-----------|--|-------|--------|----|----|----|----|---|
| HAL-32-BK | Halston overlap fixed front - Black | HNG 1 | \$ 869 | Y | Y | 14 | 14 | Y |
| HAL-32-GM | Halston overlap fixed front - Gun Metal | HNG 1 | \$ 929 | 14 | 14 | 14 | 14 | Y |
| HAL-32-NB | Halston overlap fixed front - New Bronze | HNG 1 | \$ 929 | 14 | 14 | 14 | 14 | Y |



Arcadia



Chateau Forge



Clean Face Kit

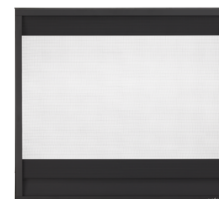

Firescreen

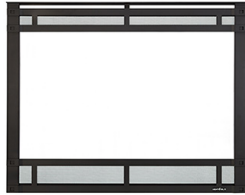

Halston

| Refractory | | | | | | | | | | |
|---|--|-------|----|-----|----|----|----|----|---|--|
| Glass Refractory SL | | | | | | | | | | |
| GLASS-5 | Reflective black glass refractory | HNG 1 | \$ | 609 | 14 | 21 | 14 | 14 | Y | |
| Refractory Upgrade | | | | | | | | | | |
| Brick Refractory SL | | | | | | | | | | |
| BRICK-SL5 | Stratford, 3 piece brick refractory | HNG 1 | \$ | 369 | 14 | Y | 14 | 14 | Y | |
| Fans | | | | | | | | | | |
| Fan | | | | | | | | | | |
| GFK-160C | Fan kit 160 CFM (fan only) | HTI 1 | \$ | 259 | Y | Y | Y | Y | Y | |
| GFK-160A | Fan kit 160 CFM (includes rheostat and temperature sensor) | HTI 1 | \$ | 319 | Y | Y | Y | Y | Y | |
| Trim Kits | | | | | | | | | | |
| Trim Kit 550 | | | | | | | | | | |
| 550-TRIM3-BK-B | Trim Kit, 3 Sided - Black (not for use with Clean Face Kit) | HTI 1 | \$ | 309 | Y | Y | Y | 14 | Y | |
| 550-TRIM4-BK-B | Trim Kit, 4 Sided - Black (not for use with Clean Face Kit) | HTI 1 | \$ | 369 | Y | 14 | Y | 14 | Y | |
| Heat Management | | | | | | | | | | |
| Heat Zone Kit | | | | | | | | | | |
| HEAT-ZONE-GAS | Heat-Zone Kit includes fan, 20' of 6" round duct, vent, wall adapter & on/off control. Wire Plug Assembly 26D0619 required if controlling w/RC400 remote. Used in IFT units with ACM & not a GFK fan. Compatible for up to 2 HEAT-ZONE-GAS kits. See manual. | HTI 1 | \$ | 569 | Y | Y | Y | Y | Y | |
| Control, remotes, wall switches | | | | | | | | | | |
| Battery Back Up | | | | | | | | | | |
| BATTERY-WSK | Battery backup wall switch kit for units with IFT control systems. Includes: On/Off Wall Switch, USB-C Port, Battery Backup, Cover Plate, 12' Wire Harness | HTI 1 | \$ | 189 | Y | 14 | Y | 14 | Y | |
| IntelliFire app | | | | | | | | | | |
| IFT-WFM | IntelliFire Wi-Fi Module that works with the IntelliFire iOS and Android app. Use to control all the features of your fireplace via a smart device. An RC400, RC450 or RC150 is required for thermostat control | HTI 1 | \$ | 229 | Y | Y | Y | Y | Y | |
| IntelliFire Touch Controls - Aux Module | | | | | | | | | | |
| IFT-ACM | IntelliFire Touch AUX Module. Must order if adding Fan, Lights or Power Vent and want to use the IFT-WFM. Do not need to order if using IFT-RC400 (includes IFT-ACM). | HTI 1 | \$ | 98 | Y | Y | 14 | 14 | Y | |

Touch Screen Remote

| | | | | | | | | |
|-----------|---|-------|--------|---|---|---|---|---|
| IFT-RC400 | IntelliFire Touch black remote control, docking station and auxiliary control module (on/off, flame height, thermostat mode, fan control, child lock, cold climate, timer mode, hot indicator, lights, on-screen maintenance and troubleshooting notifications) | HTI 1 | \$ 389 | Y | Y | Y | Y | Y |
|-----------|---|-------|--------|---|---|---|---|---|

Wall Switch

| | | | | | | | | |
|---------------|---|-------|--------|---|---|---|---|---|
| IFT-RC150-HNG | IntelliFire Touch white wireless wall switch (on/off, cold climate, battery strength indicator) | HNG 1 | \$ 121 | Y | Y | Y | Y | Y |
|---------------|---|-------|--------|---|---|---|---|---|



Battery Back Up



IntelliFire app



Touch Screen Remote



Wall Switch

Venting

Brick Extension Kit

| | | | | | | | | |
|--------------|--|-------|-------|---|----|----|----|---|
| HEAT-OUT-BEK | Exterior Heat-Zone brick extension kit | HTI 1 | \$ 73 | 8 | 21 | 21 | 14 | Y |
|--------------|--|-------|-------|---|----|----|----|---|

Venting Notes

Requires SLP series or SLP-Flex series pipe when venting off top of unit. See Venting section.

Requires DVP series pipe when venting off rear of unit. See Venting section.

Approved for use with PVLP-SLP, PVI-SLP-B and PVV-SLP with power vent wire harness and RC400 remote control (order separately). See venting section of manual.

SlimLine 5X

Includes:

- 14,500 - 27,500 Btu/Hour Input (NG)
- 13,000 - 25,000 Btu/Hour Input (LP)
- Five HD ceramic logs
- Ceramic glass
- Ceramic brick refractory
- LED Illuminated embers
- RC400 touchscreen remote
- GFK-160A variable speed blower
- External air shutter adjustment
- Battery backup
- Gas flex connector with shutoff valve
- Junction box
- 4" x 6-5/8" top vent collar
- 5" x 8" rear vent collar
- IntelliFire Touch ignition system



Required to Complete - Sold Separately: • Front

| | | Disc. Code | MSRP USD | 004 IA | 010 PA | 014 CA | 016 NC | EXP |
|----------------|--|------------|----------|--------|--------|--------|--------|-----|
| SL-5X-IFT-S | SL-5X 32" Direct Vent gas fireplace top/rear vent with IntelliFire Touch and Stratford refractory (NG) | HNG 1 | \$ 3,639 | Y | Y | Y | 14 | N |
| SL-5X-IFT-TG | SL-5X 32" Direct Vent gas fireplace top/rear vent with IntelliFire Touch and Tranquil Greige refractory (NG) | HNG 1 | \$ 3,699 | Y | Y | Y | 14 | N |
| SL-5XLP-IFT-S | SL-5X 32" Direct Vent gas fireplace top/rear vent with IntelliFire Touch and Stratford refractory (LP) | HNG 1 | \$ 3,709 | 14 | Y | 14 | 14 | N |
| SL-5XLP-IFT-TG | SL-5X 32" Direct Vent gas fireplace top/rear vent with IntelliFire Touch and Tranquil Greige refractory (LP) | HNG 1 | \$ 3,769 | 14 | 14 | 14 | 14 | N |
| SL-5X-IFT-G | SL-5X 32" Direct Vent gas fireplace top/rear vent with IntelliFire Touch and black glass refractory (NG) | HNG 1 | \$ 4,109 | Y | Y | Y | Y | N |
| SL-5XLP-IFT-G | SL-5X 32" Direct Vent gas fireplace top/rear vent with IntelliFire Touch and black glass refractory (LP) | HNG 1 | \$ 4,179 | 14 | 14 | 14 | 14 | N |

Fronts - Non-Operable (Required to Complete)

Arcadia

| | | | | | | | | |
|-----------|---|-------|--------|----|----|----|----|---|
| ARC-32-BK | Arcadia overlap arched front - Black | HNG 1 | \$ 679 | Y | 14 | 14 | 14 | Y |
| ARC-32-GM | Arcadia overlap arched front - Gun Metal | HNG 1 | \$ 719 | 14 | 14 | 14 | 14 | Y |
| ARC-32-NB | Arcadia overlap arched front - New Bronze | HNG 1 | \$ 719 | 14 | 14 | 14 | 21 | Y |

Chateau Forge

| | | | | | | | | |
|---------|----------------------------------|-------|----------|---|----|----|----|---|
| CHAF-32 | Chateau Forge hand-crafted front | HNG 1 | \$ 1,989 | Y | 14 | 14 | 14 | Y |
|---------|----------------------------------|-------|----------|---|----|----|----|---|

Clean Face Kit

| | | | | | | | | |
|----------|--|-------|--------|----|----|----|----|---|
| CF-32-BK | Clean Face kit- includes upper and lower solid louvers and clean face front - Black | HNG 1 | \$ 499 | Y | Y | Y | 14 | Y |
| CF-32-NB | Clean Face kit- includes upper and lower solid louvers and clean face front - New Bronze | HNG 1 | \$ 549 | 14 | 14 | 14 | 14 | Y |
| CF-32-GM | Clean Face kit - includes upper and lower solid louvers and clean face front - Gun Metal | HNG 1 | \$ 549 | 14 | 14 | 14 | 14 | Y |

Firescreen

| | | | | | | | | |
|---------|------------------------------------|-------|--------|---|---|---|---|---|
| FS-5-BK | Firescreen inside fit front- Black | HNG 1 | \$ 289 | Y | Y | Y | Y | Y |
|---------|------------------------------------|-------|--------|---|---|---|---|---|

Halston

| | | | | | | | | |
|-----------|--|-------|--------|----|----|----|----|---|
| HAL-32-BK | Halston overlap fixed front - Black | HNG 1 | \$ 869 | Y | Y | 14 | 14 | Y |
| HAL-32-NB | Halston overlap fixed front - New Bronze | HNG 1 | \$ 929 | 14 | 14 | 14 | 14 | Y |
| HAL-32-GM | Halston overlap fixed front - Gun Metal | HNG 1 | \$ 929 | 14 | 14 | 14 | 14 | Y |

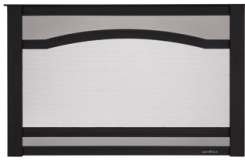

Arcadia



Chateau Forge



Clean Face Kit



Firescreen

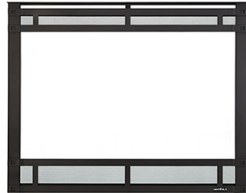

Halston

Refractory

Glass Refractory SL

| | | | | | | | | |
|----------|-----------------------------------|-------|--------|---|----|----|----|---|
| GLASS-5X | Reflective black glass refractory | HNG 1 | \$ 669 | Y | 14 | 14 | 14 | Y |
|----------|-----------------------------------|-------|--------|---|----|----|----|---|

Fans

Fan

| | | | | | | | | |
|----------|--|-------|--------|---|---|---|---|---|
| GFK-160C | Fan kit 160 CFM (fan only) | HTI 1 | \$ 259 | Y | Y | Y | Y | Y |
| GFK-160A | Fan kit 160 CFM (includes rheostat and temperature sensor) | HTI 1 | \$ 319 | Y | Y | Y | Y | Y |

Trim Kits

Trim Kit 550

| | | | | | | | | |
|----------------|---|-------|--------|---|----|---|----|---|
| 550-TRIM3-BK-B | Trim Kit, 3 Sided - Black (not for use with Clean Face Kit) | HTI 1 | \$ 309 | Y | Y | Y | 14 | Y |
| 550-TRIM4-BK-B | Trim Kit, 4 Sided - Black (not for use with Clean Face Kit) | HTI 1 | \$ 369 | Y | 14 | Y | 14 | Y |

Heat Management

Heat Out Kit

| | | | | | | | | |
|--------------|---|-------|----------|---|----|---|----|---|
| HEAT-OUT-GAS | Heat out kit (includes termination cap, 25' of 6" round duct, fireplace adapter, damper, wall switch and 350CFM fan at termination) | HTI 1 | \$ 1,529 | Y | 14 | Y | 14 | Y |
|--------------|---|-------|----------|---|----|---|----|---|

Heat Zone Kit

| | | | | | | | | |
|---------------|--|-------|--------|---|---|---|---|---|
| HEAT-ZONE-GAS | Heat-Zone Kit includes fan, 20' of 6" round duct, vent, wall adapter & on/off control. Wire Plug Assembly 26D0619 required if controlling w/RC400 remote. Used in IFT units with ACM & not a GFK fan. Compatible for up to 2 HEAT-ZONE-GAS kits. See manual. | HTI 1 | \$ 569 | Y | Y | Y | Y | Y |
|---------------|--|-------|--------|---|---|---|---|---|

Control, remotes, wall switches

Battery Back Up

| | | | | | | | | |
|-------------|--|-------|--------|---|----|---|----|---|
| BATTERY-WSK | Battery backup wall switch kit for units with IFT control systems. Includes: On/Off Wall Switch, USB-C Port, Battery Backup, Cover Plate, 12' Wire Harness | HTI 1 | \$ 189 | Y | 14 | Y | 14 | Y |
|-------------|--|-------|--------|---|----|---|----|---|

IntelliFire app

| | | | | | | | | |
|---------|---|-------|--------|---|---|---|---|---|
| IFT-WFM | IntelliFire Wi-Fi Module that works with the IntelliFire iOS and Android app. Use to control all the features of your fireplace via a smart device. An RC400, RC450 or RC150 is required for thermostat control | HTI 1 | \$ 229 | Y | Y | Y | Y | Y |
|---------|---|-------|--------|---|---|---|---|---|

Touch Screen Remote

| | | | | | | | | |
|-----------|---|-------|--------|---|---|---|---|---|
| IFT-RC400 | IntelliFire Touch black remote control, docking station and auxiliary control module (on/off, flame height, thermostat mode, fan control, child lock, cold climate, timer mode, hot indicator, lights, on-screen maintenance and troubleshooting notifications) | HTI 1 | \$ 389 | Y | Y | Y | Y | Y |
|-----------|---|-------|--------|---|---|---|---|---|

Wall Switch

| | | | | | | | | |
|---------------|---|-------|--------|---|---|---|---|---|
| IFT-RC150-HNG | IntelliFire Touch white wireless wall switch (on/off, cold climate, battery strength indicator) | HNG 1 | \$ 121 | Y | Y | Y | Y | Y |
|---------------|---|-------|--------|---|---|---|---|---|



Battery Back Up



IntelliFire app

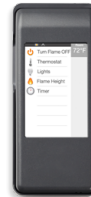

Touch Screen Remote



Wall Switch

Venting

Brick Extension Kit

| | | | | | | | | |
|--------------|--|-------|-------|---|----|----|----|---|
| HEAT-OUT-BEK | Exterior Heat-Zone brick extension kit | HTI 1 | \$ 73 | 8 | 21 | 21 | 14 | Y |
|--------------|--|-------|-------|---|----|----|----|---|

Venting Notes

Requires SLP series or SLP-Flex series pipe when venting off top of unit. See Venting section.

Requires DVP series pipe when venting off rear of unit. See Venting section.

Approved for use with PVL-PSLP, PVI-SLP-B and PVV-SLP with power vent wire harness (order separately) and IFT-RC400 remote. See venting section of manual.

SlimLine 7 w/ IFT

Includes:

- 17,500 - 25,000 Btu/Hour Input (NG)
- 17,500 - 23,500 Btu/Hour Input (LP)
- Five ceramic logs
- Tempered glass
- Glowing embers
- External air shutter adjustment
- 12' control wire
- Battery backup
- Gas flex connector with shutoff valve
- Junction box
- 5" x 8" rear vent collar
- 4" x 6-5/8" top vent collar
- IntelliFire Touch ignition system
- Optional Wi-Fi with IntelliFire App



Required to Complete - Sold Separately: • Front

| | | Disc. Code | MSRP USD | 004 IA | 010 PA | 014 CA | 016 NC | EXP |
|-------------|---|------------|----------|--------|--------|--------|--------|-----|
| SL-7-IFT | SL-7 36" Direct Vent Gas Fireplace top/rear with IntelliFire Touch (NG) | HNG 1 | \$ 2,459 | Y | Y | Y | Y | N |
| SL-7-LP-IFT | SL-7 36" Direct Vent Gas Fireplace top/rear with IntelliFire Touch (LP) | HNG 1 | \$ 2,529 | Y | Y | Y | Y | N |

Fronts - Non-Operable (Required to Complete)

Arcadia

| | | | | | | | | |
|-----------|---|-------|--------|----|----|----|----|---|
| ARC-36-BK | Arcadia overlap arched front - Black | HNG 1 | \$ 779 | Y | Y | 14 | 14 | Y |
| ARC-36-GM | Arcadia overlap arched front - Gun Metal | HNG 1 | \$ 819 | 14 | 14 | 14 | 14 | Y |
| ARC-36-NB | Arcadia overlap arched front - New Bronze | HNG 1 | \$ 819 | Y | 14 | 14 | 14 | Y |

Chateau Forge

| | | | | | | | | |
|---------|----------------------------------|-------|----------|---|----|---|----|---|
| CHAF-36 | Chateau Forge hand-crafted front | HNG 1 | \$ 2,309 | Y | 14 | Y | 21 | Y |
|---------|----------------------------------|-------|----------|---|----|---|----|---|

Clean Face Kit

| | | | | | | | | |
|----------|--|-------|--------|----|----|----|----|---|
| CF-36-BK | Clean Face kit- includes upper and lower solid louvers and clean face front - Black | HNG 1 | \$ 589 | Y | Y | Y | Y | Y |
| CF-36-NB | Clean Face kit- includes upper and lower solid louvers and clean face front - New Bronze | HNG 1 | \$ 649 | 14 | 14 | 14 | 14 | Y |
| CF-36-GM | Clean Face kit - includes upper and lower solid louvers and clean face front - Gun Metal | HNG 1 | \$ 649 | 14 | 14 | 14 | 14 | Y |

Firescreen

| | | | | | | | | |
|---------|------------------------------------|-------|--------|---|---|---|---|---|
| FS-7-BK | Firescreen inside fit front- Black | HNG 1 | \$ 319 | Y | Y | Y | Y | Y |
|---------|------------------------------------|-------|--------|---|---|---|---|---|

Halston

| | | | | | | | | |
|-----------|--|-------|--------|----|----|----|----|---|
| HAL-36-BK | Halston overlap fixed front - Black | HNG 1 | \$ 949 | Y | Y | 14 | Y | Y |
| HAL-36-GM | Halston overlap fixed front - Gun Metal | HNG 1 | \$ 989 | 14 | 14 | 14 | 14 | Y |
| HAL-36-NB | Halston overlap fixed front - New Bronze | HNG 1 | \$ 989 | Y | 14 | 14 | 14 | Y |



Arcadia



Chateau Forge



Clean Face Kit



Firescreen

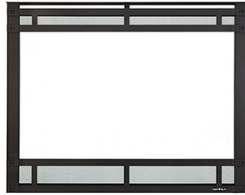

Halston

| Conversion Kit | | | | | | | | | |
|---|--|-------|----|-----|---|----|----|----|---|
| Conversion Kit | | | | | | | | | |
| LPK-SL-IFT | Conversion kit for base SL-IFT models, LP | HTI 1 | \$ | 99 | Y | Y | Y | 14 | Y |
| Refractory | | | | | | | | | |
| Glass Refractory SL | | | | | | | | | |
| GLASS-7 | Reflective black glass refractory | HNG 1 | \$ | 669 | Y | 14 | 14 | 14 | Y |
| Refractory Upgrade | | | | | | | | | |
| Brick Refractory SL | | | | | | | | | |
| BRICK-SL7 | Stratford, 3 piece brick refractory | HNG 1 | \$ | 419 | Y | Y | 14 | 14 | Y |
| Fans | | | | | | | | | |
| Fan | | | | | | | | | |
| GFK-160C | Fan kit 160 CFM (fan only) | HTI 1 | \$ | 259 | Y | Y | Y | Y | Y |
| GFK-160A | Fan kit 160 CFM (includes rheostat and temperature sensor) | HTI 1 | \$ | 319 | Y | Y | Y | Y | Y |
| Trim Kits | | | | | | | | | |
| Trim Kits | | | | | | | | | |
| 750-TRIM3-BK-B | Trim Kit, 3 Sided - Black (not for use with Clean Face Kit) | HTI 1 | \$ | 329 | Y | 14 | 14 | 14 | Y |
| 750-TRIM4-BK-B | Trim Kit, 4 Sided - Black (not for use with Clean Face Kit) | HTI 1 | \$ | 379 | Y | 14 | Y | 14 | Y |
| Heat Management | | | | | | | | | |
| Heat Zone Kit | | | | | | | | | |
| HEAT-ZONE-GAS | Heat-Zone Kit includes fan, 20' of 6" round duct, vent, wall adapter & on/off control. Wire Plug Assembly 26D0619 required if controlling w/RC400 remote. Used in IFT units with ACM & not a GFK fan. Compatible for up to 2 HEAT-ZONE-GAS kits. See manual. | HTI 1 | \$ | 569 | Y | Y | Y | Y | Y |
| Control, remotes, wall switches | | | | | | | | | |
| Battery Back Up | | | | | | | | | |
| BATTERY-WSK | Battery backup wall switch kit for units with IFT control systems. Includes: On/Off Wall Switch, USB-C Port, Battery Backup, Cover Plate, 12' Wire Harness | HTI 1 | \$ | 189 | Y | 14 | Y | 14 | Y |
| IntelliFire app | | | | | | | | | |
| IFT-WFM | IntelliFire Wi-Fi Module that works with the IntelliFire iOS and Android app. Use to control all the features of your fireplace via a smart device. An RC400, RC450 or RC150 is required for thermostat control | HTI 1 | \$ | 229 | Y | Y | Y | Y | Y |
| IntelliFire Touch Controls - Aux Module | | | | | | | | | |
| IFT-ACM | IntelliFire Touch AUX Module. Must order if adding Fan, Lights or Power Vent and want to use the IFT-WFM. Do not need to order if using IFT-RC400 (includes IFT-ACM). | HTI 1 | \$ | 98 | Y | Y | 14 | 14 | Y |

Touch Screen Remote

| | | | | | | | | |
|-----------|---|-------|--------|---|---|---|---|---|
| IFT-RC400 | IntelliFire Touch black remote control, docking station and auxiliary control module (on/off, flame height, thermostat mode, fan control, child lock, cold climate, timer mode, hot indicator, lights, on-screen maintenance and troubleshooting notifications) | HTI 1 | \$ 389 | Y | Y | Y | Y | Y |
|-----------|---|-------|--------|---|---|---|---|---|

Wall Switch

| | | | | | | | | |
|---------------|---|-------|--------|---|---|---|---|---|
| IFT-RC150-HNG | IntelliFire Touch white wireless wall switch (on/off, cold climate, battery strength indicator) | HNG 1 | \$ 121 | Y | Y | Y | Y | Y |
|---------------|---|-------|--------|---|---|---|---|---|



Battery Back Up



IntelliFire app

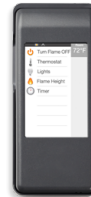

Touch Screen Remote



Wall Switch

Venting

Brick Extension Kit

| | | | | | | | | |
|--------------|--|-------|-------|---|----|----|----|---|
| HEAT-OUT-BEK | Exterior Heat-Zone brick extension kit | HTI 1 | \$ 73 | 8 | 21 | 21 | 14 | Y |
|--------------|--|-------|-------|---|----|----|----|---|

Venting Notes

Requires SLP series or SLP-Flex series pipe when venting off top of unit. See Venting section.

Requires DVP series pipe when venting off rear of unit. See Venting section.

Approved for use with PVLP-SLP, PVI-SLP-B and PVV-SLP with power vent wire harness and RC400 remote control (order separately). See venting section of manual.

SlimLine 7X

Includes:

- 17,500 - 30,500 Btu/Hour Input (NG)
- 18,000 - 29,500 Btu/Hour Input (LP)
- Five HD ceramic logs
- Ceramic glass
- Ceramic brick refractory
- LED Illuminated embers
- RC400 touchscreen remote
- GFK-160A variable speed blower
- External air shutter adjustment
- Battery backup
- Gas flex connector with shut-off valve
- Junction box
- 5" x 8" rear vent collar
- 4" x 6-5/8" top vent collar
- IntelliFire Touch ignition system



Required to Complete - Sold Separately: • Front

| | | Disc. Code | MSRP USD | 004 IA | 010 PA | 014 CA | 016 NC | EXP |
|----------------|--|------------|----------|--------|--------|--------|--------|-----|
| SL-7X-IFT-S | SL-7X 36" Direct Vent gas fireplace top/rear vent with IntelliFire Touch and Stratford refractory (NG) | HNG 1 | \$ 4,069 | Y | Y | Y | Y | N |
| SL-7X-IFT-TG | SL-7X 36" Direct Vent gas fireplace top/rear vent with IntelliFire Touch and Tranquil Greige refractory (NG) | HNG 1 | \$ 4,129 | Y | Y | Y | Y | N |
| SL-7XLP-IFT-S | SL-7X 36" Direct Vent gas fireplace top/rear vent with IntelliFire Touch and Stratford refractory (LP) | HNG 1 | \$ 4,139 | 14 | Y | Y | 14 | N |
| SL-7XLP-IFT-TG | SL-7X 36" Direct Vent gas fireplace top/rear vent with IntelliFire Touch and Tranquil Greige refractory (LP) | HNG 1 | \$ 4,199 | Y | Y | 14 | 14 | N |
| SL-7X-IFT-G | SL-7X 36" Direct Vent gas fireplace top/rear vent with IntelliFire Touch and black glass refractory (NG) | HNG 1 | \$ 4,609 | Y | Y | Y | Y | N |
| SL-7XLP-IFT-G | SL-7X 36" Direct Vent gas fireplace top/rear vent with IntelliFire Touch and black glass refractory (LP) | HNG 1 | \$ 4,689 | Y | Y | 14 | 14 | N |

Fronts - Non-Operable (Required to Complete)

Arcadia

| | | | | | | | | |
|-----------|---|-------|--------|----|----|----|----|---|
| ARC-36-BK | Arcadia overlap arched front - Black | HNG 1 | \$ 779 | Y | Y | 14 | 14 | Y |
| ARC-36-GM | Arcadia overlap arched front - Gun Metal | HNG 1 | \$ 819 | 14 | 14 | 14 | 14 | Y |
| ARC-36-NB | Arcadia overlap arched front - New Bronze | HNG 1 | \$ 819 | Y | 14 | 14 | 14 | Y |

Chateau Forge

| | | | | | | | | |
|---------|----------------------------------|-------|----------|---|----|---|----|---|
| CHAF-36 | Chateau Forge hand-crafted front | HNG 1 | \$ 2,309 | Y | 14 | Y | 21 | Y |
|---------|----------------------------------|-------|----------|---|----|---|----|---|

Clean Face Kit

| | | | | | | | | |
|----------|--|-------|--------|----|----|----|----|---|
| CF-36-BK | Clean Face kit- includes upper and lower solid louvers and clean face front - Black | HNG 1 | \$ 589 | Y | Y | Y | Y | Y |
| CF-36-NB | Clean Face kit- includes upper and lower solid louvers and clean face front - New Bronze | HNG 1 | \$ 649 | 14 | 14 | 14 | 14 | Y |
| CF-36-GM | Clean Face kit - includes upper and lower solid louvers and clean face front - Gun Metal | HNG 1 | \$ 649 | 14 | 14 | 14 | 14 | Y |

Firescreen

| | | | | | | | | |
|---------|------------------------------------|-------|--------|---|---|---|---|---|
| FS-7-BK | Firescreen inside fit front- Black | HNG 1 | \$ 319 | Y | Y | Y | Y | Y |
|---------|------------------------------------|-------|--------|---|---|---|---|---|

Halston

| | | | | | | | | |
|-----------|--|-------|--------|----|----|----|----|---|
| HAL-36-BK | Halston overlap fixed front - Black | HNG 1 | \$ 949 | Y | Y | 14 | Y | Y |
| HAL-36-GM | Halston overlap fixed front - Gun Metal | HNG 1 | \$ 989 | 14 | 14 | 14 | 14 | Y |
| HAL-36-NB | Halston overlap fixed front - New Bronze | HNG 1 | \$ 989 | Y | 14 | 14 | 14 | Y |



Arcadia



Chateau Forge



Clean Face Kit

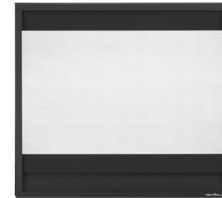

Firescreen

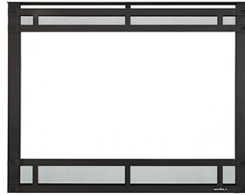

Halston

| Refractory | | | | | | | | | | |
|---------------------------------|--|-------|----|-------|----|----|----|----|----|---|
| Glass Refractory SL | | | | | | | | | | |
| GLASS-7X | Reflective black glass refractory | HNG 1 | \$ | 739 | 14 | 14 | 14 | 14 | 14 | Y |
| Fans | | | | | | | | | | |
| Fan | | | | | | | | | | |
| GFK-160C | Fan kit 160 CFM (fan only) | HTI 1 | \$ | 259 | Y | Y | Y | Y | Y | Y |
| GFK-160A | Fan kit 160 CFM (includes rheostat and temperature sensor) | HTI 1 | \$ | 319 | Y | Y | Y | Y | Y | Y |
| Trim Kits | | | | | | | | | | |
| Trim Kits | | | | | | | | | | |
| 750-TRIM3-BK-B | Trim Kit, 3 Sided - Black (not for use with Clean Face Kit) | HTI 1 | \$ | 329 | Y | 14 | 14 | 14 | 14 | Y |
| 750-TRIM4-BK-B | Trim Kit, 4 Sided - Black (not for use with Clean Face Kit) | HTI 1 | \$ | 379 | Y | 14 | Y | 14 | Y | Y |
| Heat Management | | | | | | | | | | |
| Heat Out Kit | | | | | | | | | | |
| HEAT-OUT-GAS | Heat out kit (includes termination cap, 25' of 6" round duct, fireplace adapter, damper, wall switch and 350CFM fan at termination) | HTI 1 | \$ | 1,529 | Y | 14 | Y | 14 | Y | Y |
| Heat Zone Kit | | | | | | | | | | |
| HEAT-ZONE-GAS | Heat-Zone Kit includes fan, 20' of 6" round duct, vent, wall adapter & on/off control. Wire Plug Assembly 26D0619 required if controlling w/RC400 remote. Used in IFT units with ACM & not a GFK fan. Compatible for up to 2 HEAT-ZONE-GAS kits. See manual. | HTI 1 | \$ | 569 | Y | Y | Y | Y | Y | Y |
| Control, remotes, wall switches | | | | | | | | | | |
| Battery Back Up | | | | | | | | | | |
| BATTERY-WSK | Battery backup wall switch kit for units with IFT control systems. Includes: On/Off Wall Switch, USB-C Port, Battery Backup, Cover Plate, 12' Wire Harness | HTI 1 | \$ | 189 | Y | 14 | Y | 14 | Y | Y |
| IntelliFire app | | | | | | | | | | |
| IFT-WFM | IntelliFire Wi-Fi Module that works with the IntelliFire iOS and Android app. Use to control all the features of your fireplace via a smart device. An RC400, RC450 or RC150 is required for thermostat control | HTI 1 | \$ | 229 | Y | Y | Y | Y | Y | Y |

Touch Screen Remote

| | | | | | | | | |
|-----------|---|-------|--------|---|---|---|---|---|
| IFT-RC400 | IntelliFire Touch black remote control, docking station and auxiliary control module (on/off, flame height, thermostat mode, fan control, child lock, cold climate, timer mode, hot indicator, lights, on-screen maintenance and troubleshooting notifications) | HTI 1 | \$ 389 | Y | Y | Y | Y | Y |
|-----------|---|-------|--------|---|---|---|---|---|

Wall Switch

| | | | | | | | | |
|---------------|---|-------|--------|---|---|---|---|---|
| IFT-RC150-HNG | IntelliFire Touch white wireless wall switch (on/off, cold climate, battery strength indicator) | HNG 1 | \$ 121 | Y | Y | Y | Y | Y |
|---------------|---|-------|--------|---|---|---|---|---|



Battery Back Up



IntelliFire app

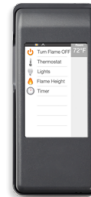

Touch Screen Remote



Wall Switch

Venting

Brick Extension Kit

| | | | | | | | | |
|--------------|--|-------|-------|---|----|----|----|---|
| HEAT-OUT-BEK | Exterior Heat-Zone brick extension kit | HTI 1 | \$ 73 | 8 | 21 | 21 | 14 | Y |
|--------------|--|-------|-------|---|----|----|----|---|

Venting Notes

Requires SLP series or SLP-Flex series pipe when venting off top of unit. See Venting section.

Requires DVP series pipe when venting off rear of unit. See Venting section.

Approved for use with PVLP-SLP, PVI-SLP-B and PVV-SLP with power vent wire harness (order separately) and IFT-RC400 remote. See venting section of manual.

SlimLine 9 w/ IFT

Includes:

- 23,500 - 30,000 Btu/Hour Input (NG)
- 21,500 - 30,000 Btu/Hour Input (LP)
- Five ceramic logs
- Tempered glass
- Glowing embers
- External air shutter adjustment
- 12' control wire
- Battery backup
- Gas flex connector with shut-off valve
- Junction box
- 4" x 6-5/8" top vent collar
- 5" x 8" rear vent collar
- IntelliFire Touch ignition system
- Optional Wi-Fi with Intellifire App



Required to Complete - Sold Separately: • Front

| | | Disc. Code | MSRP USD | 004 IA | 010 PA | 014 CA | 016 NC | EXP |
|------------|---|------------|----------|--------|--------|--------|--------|-----|
| SL-9-IFT | SL-9 Direct Vent Gas Fireplace top/rear with IntelliFire Touch (NG) | HNG 1 | \$ 2,689 | Y | Y | Y | Y | N |
| SL-9LP-IFT | SL-9 Direct Vent Gas Fireplace top/rear with IntelliFire Touch (LP) | HNG 1 | \$ 2,759 | Y | 14 | 14 | Y | N |

Fronts - Non-Operable (Required to Complete)

Arcadia

| | | | | | | | | |
|-----------|---|-------|--------|----|----|----|----|---|
| ARC-42-BK | Arcadia overlap arched front - Black | HNG 1 | \$ 889 | Y | 14 | 14 | 14 | N |
| ARC-42-GM | Arcadia overlap arched front - Gun Metal | HNG 1 | \$ 939 | 14 | 14 | 14 | 14 | Y |
| ARC-42-NB | Arcadia overlap arched front - New Bronze | HNG 1 | \$ 939 | 14 | 14 | 14 | 14 | Y |

Chateau Forge

| | | | | | | | | |
|---------|----------------------------------|-------|----------|----|---|----|----|---|
| CHAF-42 | Chateau Forge hand-crafted front | HNG 1 | \$ 2,529 | 14 | Y | 14 | 14 | Y |
|---------|----------------------------------|-------|----------|----|---|----|----|---|

Clean Face Kit

| | | | | | | | | |
|----------|--|-------|--------|----|----|----|----|---|
| CF-42-BK | Clean Face kit- includes upper and lower solid louvers and clean face front - Black | HNG 1 | \$ 649 | Y | Y | Y | Y | Y |
| CF-42-GM | Clean Face kit - includes upper and lower solid louvers and clean face front - Gun Metal | HNG 1 | \$ 689 | 14 | 14 | 14 | 14 | Y |
| CF-42-NB | Clean Face kit- includes upper and lower solid louvers and clean face front - New Bronze | HNG 1 | \$ 689 | 14 | 14 | 14 | 14 | Y |

Firescreen

| | | | | | | | | |
|---------|------------------------------------|-------|--------|---|---|---|---|---|
| FS-9-BK | Firescreen inside fit front- Black | HNG 1 | \$ 339 | Y | Y | Y | Y | Y |
|---------|------------------------------------|-------|--------|---|---|---|---|---|

Halston

| | | | | | | | | |
|-----------|--|-------|----------|----|----|----|----|---|
| HAL-42-BK | Halston overlap fixed front - Black | HNG 1 | \$ 999 | Y | 14 | 14 | 14 | N |
| HAL-42-NB | Halston overlap fixed front - New Bronze | HNG 1 | \$ 1,059 | 14 | 14 | 14 | 14 | N |
| HAL-42-GM | Halston overlap fixed front - Gun Metal | HNG 1 | \$ 1,059 | 14 | 14 | 14 | 14 | N |



Arcadia



Chateau Forge



Clean Face Kit



Firescreen

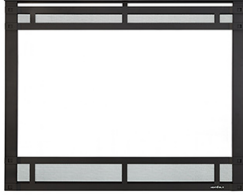

Halston

| Conversion Kit | | | | | | | | | | |
|---|---|-------|----|-----|----|----|----|----|---|--|
| Conversion Kit | | | | | | | | | | |
| LPK-SL-IFT | Conversion kit for base SL-IFT models, LP | HTI 1 | \$ | 99 | Y | Y | Y | 14 | Y | |
| Refractory | | | | | | | | | | |
| Glass Refractory SL | | | | | | | | | | |
| GLASS-9 | Reflective black glass refractory | HNG 1 | \$ | 739 | 14 | 21 | 14 | 14 | Y | |
| Refractory Upgrade | | | | | | | | | | |
| Brick Refractory SL | | | | | | | | | | |
| BRICK-SL9 | Stratford, 3 piece brick refractory | HNG 1 | \$ | 459 | 14 | 21 | 14 | 14 | Y | |
| Fans | | | | | | | | | | |
| Fan | | | | | | | | | | |
| GFK-160C | Fan kit 160 CFM (fan only) | HTI 1 | \$ | 259 | Y | Y | Y | Y | Y | |
| GFK-160A | Fan kit 160 CFM (includes rheostat and temperature sensor) | HTI 1 | \$ | 319 | Y | Y | Y | Y | Y | |
| Heat Management | | | | | | | | | | |
| Heat Zone Kit | | | | | | | | | | |
| HEAT-ZONE-GAS | Heat-Zone Kit includes fan, 20' of 6" round duct, vent, wall adapter & on/off control. Wire Plug Assembly 26D0619 required if controlling w/RC400 remote. Used in IFT units with ACM & not a GFK fan. Compatible for up to 2 HEAT-ZONE-GAS kits. See manual. | HTI 1 | \$ | 569 | Y | Y | Y | Y | Y | |
| Control, remotes, wall switches | | | | | | | | | | |
| Battery Back Up | | | | | | | | | | |
| BATTERY-WSK | Battery backup wall switch kit for units with IFT control systems. Includes: On/Off Wall Switch, USB-C Port, Battery Backup, Cover Plate, 12' Wire Harness | HTI 1 | \$ | 189 | Y | 14 | Y | 14 | Y | |
| IntelliFire app | | | | | | | | | | |
| IFT-WFM | IntelliFire Wi-Fi Module that works with the IntelliFire iOS and Android app. Use to control all the features of your fireplace via a smart device. An RC400, RC450 or RC150 is required for thermostat control | HTI 1 | \$ | 229 | Y | Y | Y | Y | Y | |
| IntelliFire Touch Controls - Aux Module | | | | | | | | | | |
| IFT-ACM | IntelliFire Touch AUX Module. Must order if adding Fan, Lights or Power Vent and want to use the IFT-WFM. Do not need to order if using IFT-RC400 (includes IFT-ACM). | HTI 1 | \$ | 98 | Y | Y | 14 | 14 | Y | |
| Touch Screen Remote | | | | | | | | | | |
| IFT-RC400 | IntelliFire Touch black remote control, docking station and auxiliary control module (on/off, flame height, thermostat mode, fan control, child lock, cold climate, timer mode, hot indicator, lights, on-screen maintenance and troubleshooting notifications) | HTI 1 | \$ | 389 | Y | Y | Y | Y | Y | |

Wall Switch

| | | | | | | | | |
|---------------|---|-------|--------|---|---|---|---|---|
| IFT-RC150-HNG | IntelliFire Touch white wireless wall switch (on/off, cold climate, battery strength indicator) | HNG 1 | \$ 121 | Y | Y | Y | Y | Y |
|---------------|---|-------|--------|---|---|---|---|---|



Battery Back Up



IntelliFire app

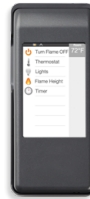

Touch Screen Remote



Wall Switch

Venting

Brick Extension Kit

| | | | | | | | | |
|--------------|--|-------|-------|---|----|----|----|---|
| HEAT-OUT-BEK | Exterior Heat-Zone brick extension kit | HTI 1 | \$ 73 | 8 | 21 | 21 | 14 | Y |
|--------------|--|-------|-------|---|----|----|----|---|

Venting Notes

- Requires SLP series or SLP-Flex series pipe when venting off top of unit. See Venting section.
- Requires DVP series pipe when venting off rear of unit. See Venting section.
- Approved for use with PVLP-SLP, PVI-SLP-B and PVV-SLP with power vent wire harness and RC400 remote control (order separately). See venting section of manual.

SlimLine 9X

Includes:

- 18,000 - 35,000 Btu/Hour Input (NG)
- 16,500 - 31,000 Btu/Hour Input (LP)
- Five HD ceramic logs
- Ceramic glass
- Ceramic brick refractory
- LED Illuminated embers
- RC400 touchscreen remote
- GFK-160A variable speed blower
- External air shutter adjustment
- Battery backup
- Gas flex connector with shut-off valve
- Junction box
- 4" x 6-5/8" top vent collar
- 5" x 8" rear vent collar
- IntelliFire Touch ignition system



Required to Complete - Sold Separately: • Front

| | | Disc. Code | MSRP USD | 004 IA | 010 PA | 014 CA | 016 NC | EXP |
|--------------|--|------------|----------|--------|--------|--------|--------|-----|
| SL-9X-IFT-S | SL-9X 42" Direct Vent gas fireplace top/rear vent with IntelliFire Touch and Stratford refractory (NG) | HNG 1 | \$ 4,459 | 14 | 14 | 14 | 14 | N |
| SL-9X-IFT-TG | SL-9X 42" Direct Vent gas fireplace top/rear vent with IntelliFire Touch and Tranquil Greige refractory (NG) | HNG 1 | \$ 4,529 | Y | Y | 14 | Y | N |
| SL-9X-IFT-G | SL-9X 42" Direct Vent gas fireplace top/rear vent with IntelliFire Touch and black glass refractory (NG) | HNG 1 | \$ 5,119 | Y | Y | 14 | Y | N |

Fronts - Non-Operable (Required to Complete)

Arcadia

| | | | | | | | | |
|-----------|---|-------|--------|----|----|----|----|---|
| ARC-42-BK | Arcadia overlap arched front - Black | HNG 1 | \$ 889 | Y | 14 | 14 | 14 | N |
| ARC-42-GM | Arcadia overlap arched front - Gun Metal | HNG 1 | \$ 939 | 14 | 14 | 14 | 14 | Y |
| ARC-42-NB | Arcadia overlap arched front - New Bronze | HNG 1 | \$ 939 | 14 | 14 | 14 | 14 | Y |

Chateau Forge

| | | | | | | | | |
|---------|----------------------------------|-------|----------|----|---|----|----|---|
| CHAF-42 | Chateau Forge hand-crafted front | HNG 1 | \$ 2,529 | 14 | Y | 14 | 14 | Y |
|---------|----------------------------------|-------|----------|----|---|----|----|---|

Clean Face Kit

| | | | | | | | | |
|----------|--|-------|--------|----|----|----|----|---|
| CF-42-BK | Clean Face kit- includes upper and lower solid louvers and clean face front - Black | HNG 1 | \$ 649 | Y | Y | Y | Y | Y |
| CF-42-GM | Clean Face kit - includes upper and lower solid louvers and clean face front - Gun Metal | HNG 1 | \$ 689 | 14 | 14 | 14 | 14 | Y |
| CF-42-NB | Clean Face kit- includes upper and lower solid louvers and clean face front - New Bronze | HNG 1 | \$ 689 | 14 | 14 | 14 | 14 | Y |

Firescreen

| | | | | | | | | |
|---------|------------------------------------|-------|--------|---|---|---|---|---|
| FS-9-BK | Firescreen inside fit front- Black | HNG 1 | \$ 339 | Y | Y | Y | Y | Y |
|---------|------------------------------------|-------|--------|---|---|---|---|---|

Halston

| | | | | | | | | |
|-----------|--|-------|----------|----|----|----|----|---|
| HAL-42-BK | Halston overlap fixed front - Black | HNG 1 | \$ 999 | Y | 14 | 14 | 14 | N |
| HAL-42-NB | Halston overlap fixed front - New Bronze | HNG 1 | \$ 1,059 | 14 | 14 | 14 | 14 | N |
| HAL-42-GM | Halston overlap fixed front - Gun Metal | HNG 1 | \$ 1,059 | 14 | 14 | 14 | 14 | N |



Arcadia



Chateau Forge



Clean Face Kit

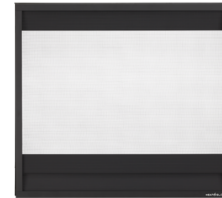

Firescreen

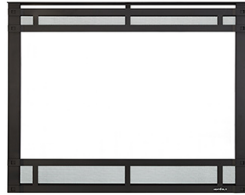

Halston

Conversion Kit

Conversion Kit

| | | | | | | | | |
|----------|-------------------------|-------|-------|---|---|---|---|---|
| LPK-SL9X | NG to LP conversion kit | HNG 1 | \$ 99 | Y | Y | Y | Y | Y |
|----------|-------------------------|-------|-------|---|---|---|---|---|

Refractory

Glass Refractory SL

| | | | | | | | | |
|----------|-----------------------------------|-------|--------|----|----|----|----|---|
| GLASS-9X | Reflective black glass refractory | HNG 1 | \$ 859 | 14 | 14 | 14 | 14 | Y |
|----------|-----------------------------------|-------|--------|----|----|----|----|---|

Fans

Fan

| | | | | | | | | |
|----------|--|-------|--------|---|---|---|---|---|
| GFK-160C | Fan kit 160 CFM (fan only) | HTI 1 | \$ 259 | Y | Y | Y | Y | Y |
| GFK-160A | Fan kit 160 CFM (includes rheostat and temperature sensor) | HTI 1 | \$ 319 | Y | Y | Y | Y | Y |

Heat Management

Heat Out Kit

| | | | | | | | | |
|--------------|---|-------|----------|---|----|---|----|---|
| HEAT-OUT-GAS | Heat out kit (includes termination cap, 25' of 6" round duct, fireplace adapter, damper, wall switch and 350CFM fan at termination) | HTI 1 | \$ 1,529 | Y | 14 | Y | 14 | Y |
|--------------|---|-------|----------|---|----|---|----|---|

Heat Zone Kit

| | | | | | | | | |
|---------------|--|-------|--------|---|---|---|---|---|
| HEAT-ZONE-GAS | Heat-Zone Kit includes fan, 20' of 6" round duct, vent, wall adapter & on/off control. Wire Plug Assembly 26D0619 required if controlling w/RC400 remote. Used in IFT units with ACM & not a GFK fan. Compatible for up to 2 HEAT-ZONE-GAS kits. See manual. | HTI 1 | \$ 569 | Y | Y | Y | Y | Y |
|---------------|--|-------|--------|---|---|---|---|---|

Control, remotes, wall switches

Battery Back Up

| | | | | | | | | |
|-------------|--|-------|--------|---|----|---|----|---|
| BATTERY-WSK | Battery backup wall switch kit for units with IFT control systems. Includes: On/Off Wall Switch, USB-C Port, Battery Backup, Cover Plate, 12' Wire Harness | HTI 1 | \$ 189 | Y | 14 | Y | 14 | Y |
|-------------|--|-------|--------|---|----|---|----|---|

IntelliFire app

| | | | | | | | | |
|---------|---|-------|--------|---|---|---|---|---|
| IFT-WFM | IntelliFire Wi-Fi Module that works with the IntelliFire iOS and Android app. Use to control all the features of your fireplace via a smart device. An RC400, RC450 or RC150 is required for thermostat control | HTI 1 | \$ 229 | Y | Y | Y | Y | Y |
|---------|---|-------|--------|---|---|---|---|---|

Touch Screen Remote

| | | | | | | | | |
|-----------|---|-------|--------|---|---|---|---|---|
| IFT-RC400 | IntelliFire Touch black remote control, docking station and auxiliary control module (on/off, flame height, thermostat mode, fan control, child lock, cold climate, timer mode, hot indicator, lights, on-screen maintenance and troubleshooting notifications) | HTI 1 | \$ 389 | Y | Y | Y | Y | Y |
|-----------|---|-------|--------|---|---|---|---|---|

Wall Switch

| | | | | | | | | |
|---------------|---|-------|--------|---|---|---|---|---|
| IFT-RC150-HNG | IntelliFire Touch white wireless wall switch (on/off, cold climate, battery strength indicator) | HNG 1 | \$ 121 | Y | Y | Y | Y | Y |
|---------------|---|-------|--------|---|---|---|---|---|



Battery Back Up



IntelliFire app



Touch Screen Remote



Wall Switch

Venting

Brick Extension Kit

| | | | | | | | | |
|--------------|--|-------|-------|---|----|----|----|---|
| HEAT-OUT-BEK | Exterior Heat-Zone brick extension kit | HTI 1 | \$ 73 | 8 | 21 | 21 | 14 | Y |
|--------------|--|-------|-------|---|----|----|----|---|

Venting Notes

Requires SLP series or SLP-Flex series pipe when venting off top of unit. See Venting section.

Requires DVP series pipe when venting off rear of unit. See Venting section.

Approved for use with PVLP-SLP, PVI-SLP-B and PVV-SLP with power vent wire harness (order separately) and IFT-RC400 remote. See venting section of manual.

SlimLine Fusion 5 w/ IFT

Includes:

- 12,000 -19,500 Btu/Hour Input (NG)
- 13,500-17,000 Btu/Hour Input (LP)
- Tempered glass
- 5" x 8" rear vent collar
- 4" x 6-5/8" top vent collar
- 12' control wire
- Full coverage mesh front
- Black hood
- Gas flex connector
- Log set
- Battery backup
- Junction box
- IntelliFire Touch ignition
- Optional Wi-Fi with Intellifire App



No additional items required to complete.

| | | Disc. | MSRP | 004 | 010 | 014 | 016 | EXP |
|-----------|---|-------|----------|-----|-----|-----|-----|-----|
| | | Code | USD | IA | PA | CA | NC | |
| SL-5F-IFT | SL-5 32" Direct Vent Gas Fireplace top/rear with IntelliFire Touch (NG) | HNG 1 | \$ 2,049 | Y | 14 | Y | 14 | N |

Conversion Kit

Conversion Kit

| | | | | | | | | |
|------------|---|-------|-------|---|---|---|----|---|
| LPK-SL-IFT | Conversion kit for base SL-IFT models, LP | HTI 1 | \$ 99 | Y | Y | Y | 14 | Y |
|------------|---|-------|-------|---|---|---|----|---|

Fronts - Non-Operable

Clean Face Kit

| | | | | | | | | |
|----------|--|-------|--------|----|----|----|----|---|
| CF-32-BK | Clean Face kit- includes upper and lower solid louvers and clean face front - Black | HNG 1 | \$ 499 | Y | Y | Y | 14 | Y |
| CF-32-NB | Clean Face kit- includes upper and lower solid louvers and clean face front - New Bronze | HNG 1 | \$ 549 | 14 | 14 | 14 | 14 | Y |
| CF-32-GM | Clean Face kit - includes upper and lower solid louvers and clean face front - Gun Metal | HNG 1 | \$ 549 | 14 | 14 | 14 | 14 | Y |



Clean Face Kit

Media

Crushed Glass Media

| | | | | | | | | |
|---------------|--|-------|--------|---|----|----|----|---|
| MEDIA-AMBER | Glass media, Amber | HTI 1 | \$ 123 | Y | 14 | Y | 14 | Y |
| MEDIA-COBALT | Glass media, Cobalt Blue | HTI 1 | \$ 123 | Y | 14 | 14 | 14 | Y |
| MEDIA-BLACK | Glass media, Ebony (black) | HTI 1 | \$ 123 | Y | Y | Y | Y | Y |
| MEDIA-CRYSTAL | Glass media, Crystal (translucent white) | HTI 1 | \$ 123 | Y | Y | Y | Y | Y |

Glass Bead Media

| | | | | | | | | |
|----------------|---------------------|-------|--------|----|----|----|----|---|
| MEDIA-BK2-GEMS | Glass beads, Black | HTI 1 | \$ 189 | Y | 21 | Y | 14 | Y |
| MEDIA-CL2-GEMS | Glass beads - Clear | HTI 1 | \$ 189 | 14 | 21 | 14 | 14 | Y |
| MEDIA-WH2-GEMS | Glass beads - White | HTI 1 | \$ 189 | 14 | 21 | 14 | 14 | Y |

| Stone Media | | | | | | | | | | |
|---|---|-------|--------|----|----|----|----|----|----|---|
| STONES-FUSION | Large, multi-colored fiber stone media | HTI 1 | \$ 299 | 14 | 14 | 14 | 14 | 14 | 14 | Y |
| Refractory | | | | | | | | | | |
| Slim Line 550 Glass Refractory | | | | | | | | | | |
| GLASS550-LINER | Reflective black ceramic glass refractory | HTI 1 | \$ 549 | 14 | 14 | 14 | 14 | 14 | 14 | Y |
| Fans | | | | | | | | | | |
| Fan | | | | | | | | | | |
| GFK-160C | Fan kit 160 CFM (fan only) | HTI 1 | \$ 259 | Y | Y | Y | Y | Y | Y | Y |
| GFK-160A | Fan kit 160 CFM (includes rheostat and temperature sensor) | HTI 1 | \$ 319 | Y | Y | Y | Y | Y | Y | Y |
| Trim Kits | | | | | | | | | | |
| Trim Kit 550 | | | | | | | | | | |
| 550-TRIM3-BK-B | Trim Kit, 3 Sided - Black (not for use with Clean Face Kit) | HTI 1 | \$ 309 | Y | Y | Y | 14 | 14 | 14 | Y |
| 550-TRIM4-BK-B | Trim Kit, 4 Sided - Black (not for use with Clean Face Kit) | HTI 1 | \$ 369 | Y | 14 | Y | 14 | 14 | 14 | Y |
| Control, remotes, wall switches | | | | | | | | | | |
| Battery Back Up | | | | | | | | | | |
| BATTERY-WSK | Battery backup wall switch kit for units with IFT control systems. Includes: On/Off Wall Switch, USB-C Port, Battery Backup, Cover Plate, 12' Wire Harness | HTI 1 | \$ 189 | Y | 14 | Y | 14 | 14 | 14 | Y |
| IntelliFire app | | | | | | | | | | |
| IFT-WFM | IntelliFire Wi-Fi Module that works with the IntelliFire iOS and Android app. Use to control all the features of your fireplace via a smart device. An RC400, RC450 or RC150 is required for thermostat control | HTI 1 | \$ 229 | Y | Y | Y | Y | Y | Y | Y |
| IntelliFire Touch Controls - Aux Module | | | | | | | | | | |
| IFT-ACM | IntelliFire Touch AUX Module. Must order if adding Fan, Lights or Power Vent and want to use the IFT-WFM. Do not need to order if using IFT-RC400 (includes IFT-ACM). | HTI 1 | \$ 98 | Y | Y | 14 | 14 | 14 | 14 | Y |
| Touch Screen Remote | | | | | | | | | | |
| IFT-RC400 | IntelliFire Touch black remote control, docking station and auxiliary control module (on/off, flame height, thermostat mode, fan control, child lock, cold climate, timer mode, hot indicator, lights, on-screen maintenance and troubleshooting notifications) | HTI 1 | \$ 389 | Y | Y | Y | Y | Y | Y | Y |
| Wall Switch | | | | | | | | | | |
| IFT-RC150-HNG | IntelliFire Touch white wireless wall switch (on/off, cold climate, battery strength indicator) | HNG 1 | \$ 121 | Y | Y | Y | Y | Y | Y | Y |



Battery Back Up



IntelliFire app

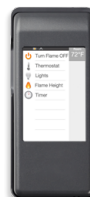

Touch Screen Remote



Wall Switch

Venting Notes

SL-5F Requires SLP series or SL-flex series pipe when venting off top of unit. See Venting section.

SL-5F Requires DVP series pipe when venting off rear of unit. See Venting section.

Approved for use with PVL-5F, PVI-5F-B and PVV-5F with power vent wire harness and RC400 remote control (order separately). See venting section of manual.

SlimLine Fusion 7 w/ IFT

Includes:

- 16,500-24,000 Btu/Hour Input (NG)
- 16,500-20,500 Btu/Hour Input (LP)
- Tempered glass
- 5" x 8" rear vent collar
- 4" x 6-5/8" top vent collar
- 12' control wire
- Full coverage mesh front
- Black hood
- Gas flex connector
- Log set
- Battery backup
- Junction box
- IntelliFire Touch ignition
- Optional Wi-Fi with Intellifire App



No additional items required to complete.

| | | Disc. | MSRP | 004 | 010 | 014 | 016 | EXP |
|-----------|--|-------|----------|-----|-----|-----|-----|-----|
| | | Code | USD | IA | PA | CA | NC | |
| SL-7F-IFT | SL-Fusion top/rear direct vent fireplace with IntelliFire Touch (NG) | HNG 1 | \$ 2,459 | Y | Y | Y | 14 | N |

Conversion Kit

Conversion Kit

| | | | | | | | | |
|------------|---|-------|-------|---|---|---|----|---|
| LPK-SL-IFT | Conversion kit for base SL-IFT models, LP | HTI 1 | \$ 99 | Y | Y | Y | 14 | Y |
|------------|---|-------|-------|---|---|---|----|---|

Fronts - Non-Operable

Clean Face Kit

| | | | | | | | | |
|----------|--|-------|--------|----|----|----|----|---|
| CF-36-BK | Clean Face kit- includes upper and lower solid louvers and clean face front - Black | HNG 1 | \$ 589 | Y | Y | Y | Y | Y |
| CF-36-NB | Clean Face kit- includes upper and lower solid louvers and clean face front - New Bronze | HNG 1 | \$ 649 | 14 | 14 | 14 | 14 | Y |
| CF-36-GM | Clean Face kit - includes upper and lower solid louvers and clean face front - Gun Metal | HNG 1 | \$ 649 | 14 | 14 | 14 | 14 | Y |



Clean Face Kit

Media

Crushed Glass Media

| | | | | | | | | |
|---------------|--|-------|--------|---|----|----|----|---|
| MEDIA-COBALT | Glass media, Cobalt Blue | HTI 1 | \$ 123 | Y | 14 | 14 | 14 | Y |
| MEDIA-BLACK | Glass media, Ebony (black) | HTI 1 | \$ 123 | Y | Y | Y | Y | Y |
| MEDIA-CRYSTAL | Glass media, Crystal (translucent white) | HTI 1 | \$ 123 | Y | Y | Y | Y | Y |
| MEDIA-AMBER | Glass media, Amber | HTI 1 | \$ 123 | Y | 14 | Y | 14 | Y |

Glass Bead Media

| | | | | | | | | |
|----------------|---------------------|-------|--------|----|----|----|----|---|
| MEDIA-WH2-GEMS | Glass beads - White | HTI 1 | \$ 189 | 14 | 21 | 14 | 14 | Y |
| MEDIA-CL2-GEMS | Glass beads - Clear | HTI 1 | \$ 189 | 14 | 21 | 14 | 14 | Y |
| MEDIA-BK2-GEMS | Glass beads, Black | HTI 1 | \$ 189 | Y | 21 | Y | 14 | Y |

| | | | | | | | | | | |
|--|---|-------|--------|----|----|----|----|----|----|---|
| Stone Media | | | | | | | | | | |
| STONES-FUSION | Large, multi-colored fiber stone media | HTI 1 | \$ 299 | 14 | 14 | 14 | 14 | 14 | 14 | Y |
| Refractory | | | | | | | | | | |
| Slim Line 750 Glass Refractory | | | | | | | | | | |
| GLASS750-LINER | Reflective black ceramic glass refractory | HTI 1 | \$ 619 | 14 | 14 | 14 | 14 | 14 | 14 | Y |
| Fans | | | | | | | | | | |
| Fan | | | | | | | | | | |
| GFK-160C | Fan kit 160 CFM (fan only) | HTI 1 | \$ 259 | Y | Y | Y | Y | Y | Y | Y |
| GFK-160A | Fan kit 160 CFM (includes rheostat and temperature sensor) | HTI 1 | \$ 319 | Y | Y | Y | Y | Y | Y | Y |
| Trim Kits | | | | | | | | | | |
| Trim Kits | | | | | | | | | | |
| 750-TRIM3-BK-B | Trim Kit, 3 Sided - Black (not for use with Clean Face Kit) | HTI 1 | \$ 329 | Y | 14 | 14 | 14 | 14 | 14 | Y |
| 750-TRIM4-BK-B | Trim Kit, 4 Sided - Black (not for use with Clean Face Kit) | HTI 1 | \$ 379 | Y | 14 | Y | 14 | 14 | 14 | Y |
| Control, remotes, wall switches | | | | | | | | | | |
| Battery Back Up | | | | | | | | | | |
| BATTERY-WSK | Battery backup wall switch kit for units with IFT control systems. Includes: On/Off Wall Switch, USB-C Port, Battery Backup, Cover Plate, 12' Wire Harness | HTI 1 | \$ 189 | Y | 14 | Y | 14 | 14 | 14 | Y |
| IntelliFire app | | | | | | | | | | |
| IFT-WFM | IntelliFire Wi-Fi Module that works with the IntelliFire iOS and Android app. Use to control all the features of your fireplace via a smart device. An RC400, RC450 or RC150 is required for thermostat control | HTI 1 | \$ 229 | Y | Y | Y | Y | Y | Y | Y |
| IntelliFire Touch Controls - Aux Module | | | | | | | | | | |
| IFT-ACM | IntelliFire Touch AUX Module. Must order if adding Fan, Lights or Power Vent and want to use the IFT-WFM. Do not need to order if using IFT-RC400 (includes IFT-ACM). | HTI 1 | \$ 98 | Y | Y | 14 | 14 | 14 | 14 | Y |
| Touch Screen Remote | | | | | | | | | | |
| IFT-RC400 | IntelliFire Touch black remote control, docking station and auxiliary control module (on/off, flame height, thermostat mode, fan control, child lock, cold climate, timer mode, hot indicator, lights, on-screen maintenance and troubleshooting notifications) | HTI 1 | \$ 389 | Y | Y | Y | Y | Y | Y | Y |
| Wall Switch | | | | | | | | | | |
| WSK-21-W | Wall switch kit- White (includes 20 ft of wire) | HTI 1 | \$ 40 | Y | Y | Y | Y | Y | Y | Y |
| Wall Switch | | | | | | | | | | |
| IFT-RC150-HNG | IntelliFire Touch white wireless wall switch (on/off, cold climate, battery strength indicator) | HNG 1 | \$ 121 | Y | Y | Y | Y | Y | Y | Y |



Battery Back Up



IntelliFire app

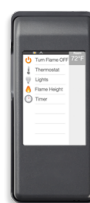

Touch Screen Remote



Wall Switch

Venting Notes

SL-7F Requires SLP series or SL-flex series pipe when venting off top of unit. See Venting section.

SL-7F Requires DVP series pipe when venting off rear of unit. See Venting section.

Approved for use with PVL-7F, PVI-7F-B and PVV-7F with power vent wire harness and RC400 remote control (order separately). See venting section of manual.

TRUE 36 IFT

Includes:

- 28,000 - 45,500 Btu/Hour Input (NG)
- 24,000 - 43,500 Btu/Hour Input (LP)
- RC400 touchscreen remote
- LED accent lighting
- LED illuminated embers
- 7 premium cast logs
- Full brick or black glass refractory
- Gas flex connector
- IntelliFire Touch ignition system
- Virtually invisible ceramic glass
- Junction box



Required to Complete - Sold Separately: • Front

| | | Disc. Code | MSRP USD | 004 IA | 010 PA | 014 CA | 016 NC | EXP |
|---------------|---|------------|----------|--------|--------|--------|--------|-----|
| TRUE-36TG-IFT | TRUE 36" Direct Vent Gas Fireplace with Tranquil Greige herringbone refractory (NG) | HNG 2 | \$ 6,799 | 14 | 14 | Y | 14 | N |
| TRUE-36S-IFT | TRUE 36" Direct Vent Gas Fireplace with Stratford refractory (NG) | HNG 2 | \$ 6,879 | 14 | 14 | 14 | 14 | N |
| TRUE-36G-IFT | TRUE 36" Direct Vent Gas Fireplace with Black glass refractory (NG) | HNG 2 | \$ 7,469 | 14 | 14 | 14 | 14 | N |

Fronts - Non-Operable (Required to Complete)

Firescreen

| | | | | | | | | |
|-------------|-------------------------------|-------|--------|----|----|----|----|---|
| FS-36IFT-BK | Firescreen front - Black | HNG 2 | \$ 709 | Y | 14 | Y | 21 | Y |
| FS-36IFT-NB | Firescreen front - New Bronze | HNG 2 | \$ 769 | 14 | 14 | 14 | 21 | Y |
| FS-36IFT-GM | Firescreen front - Gun Metal | HNG 2 | \$ 769 | 14 | 14 | 14 | 14 | Y |

Forge

| | | | | | | | | |
|-------------|--|-------|----------|----|----|----|----|---|
| FORGE-36IFT | Forge, hand-crafted, with forged bars and straps, natural finish | HNG 2 | \$ 2,239 | 14 | 14 | 14 | 21 | N |
|-------------|--|-------|----------|----|----|----|----|---|

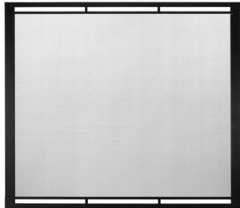

Firescreen

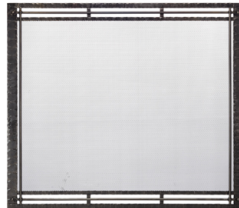

Forge

Fronts - Arched (Required to Complete)

Arched Forge - must include arch kit

| | | | | | | | | |
|--------------|---|-------|----------|----|----|----|----|---|
| FORGE-36AIFT | Arched Forge, hand-crafted, with forged bars and straps, natural finish | HNG 2 | \$ 2,419 | 14 | 14 | 14 | 21 | N |
|--------------|---|-------|----------|----|----|----|----|---|

Firescreen Arch - must include arch kit

| | | | | | | | | |
|--------------|--------------------------------------|-------|--------|----|----|----|----|---|
| FS-36AIFT-BK | Arched Firescreen front - Black | HNG 2 | \$ 779 | 14 | 14 | 14 | 21 | Y |
| FS-36AIFT-GM | Arched Firescreen front - Gun Metal | HNG 2 | \$ 819 | 14 | 14 | 14 | 14 | Y |
| FS-36AIFT-NB | Arched Firescreen front - New Bronze | HNG 2 | \$ 819 | 14 | 14 | 14 | 21 | Y |



Arched Forge

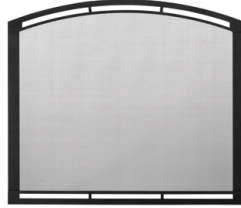

Firescreen Arch

Arch Kit

Arch Kit 36

| | | | | | | | | |
|-------------|--------------------------------------|-------|--------|----|----|----|----|---|
| ARCH-KIT-36 | Arch kit, required for arched fronts | HTI 2 | \$ 269 | 14 | 21 | 14 | 14 | Y |
|-------------|--------------------------------------|-------|--------|----|----|----|----|---|

Conversion Kit

LP Conversion Kit

| | | | | | | | | |
|------------|-------------------|-------|-------|--|----|----|----|---|
| LPK-TRUE36 | LP conversion kit | HNG 2 | \$ 99 | | 14 | 14 | 14 | Y |
|------------|-------------------|-------|-------|--|----|----|----|---|

Heat Management

Heat Out Kit

| | | | | | | | | |
|--------------|---|-------|----------|---|----|---|----|---|
| HEAT-OUT-GAS | Heat out kit (includes termination cap, 25' of 6" round duct, fireplace adapter, damper, wall switch and 350CFM fan at termination) | HTI 1 | \$ 1,529 | Y | 14 | Y | 14 | Y |
|--------------|---|-------|----------|---|----|---|----|---|

Heat Zone Kit

| | | | | | | | | |
|---------------|--|-------|--------|---|---|---|---|---|
| HEAT-ZONE-GAS | Heat-Zone Kit includes fan, 20' of 6" round duct, vent, wall adapter & on/off control. Wire Plug Assembly 26D0619 required if controlling w/RC400 remote. Used in IFT units with ACM & not a GFK fan. Compatible for up to 2 HEAT-ZONE-GAS kits. See manual. | HTI 1 | \$ 569 | Y | Y | Y | Y | Y |
|---------------|--|-------|--------|---|---|---|---|---|

Control, remotes, wall switches

Battery Back Up

| | | | | | | | | |
|-------------|--|-------|--------|---|----|---|----|---|
| BATTERY-WSK | Battery backup wall switch kit for units with IFT control systems. Includes: On/Off Wall Switch, USB-C Port, Battery Backup, Cover Plate, 12' Wire Harness | HTI 1 | \$ 189 | Y | 14 | Y | 14 | Y |
|-------------|--|-------|--------|---|----|---|----|---|

IntelliFire app

| | | | | | | | | |
|---------|---|-------|--------|---|---|---|---|---|
| IFT-WFM | IntelliFire Wi-Fi Module that works with the IntelliFire iOS and Android app. Use to control all the features of your fireplace via a smart device. An RC400, RC450 or RC150 is required for thermostat control | HTI 1 | \$ 229 | Y | Y | Y | Y | Y |
|---------|---|-------|--------|---|---|---|---|---|

Touch Screen Remote

| | | | | | | | | |
|-----------|---|-------|--------|---|---|---|---|---|
| IFT-RC400 | IntelliFire Touch black remote control, docking station and auxiliary control module (on/off, flame height, thermostat mode, fan control, child lock, cold climate, timer mode, hot indicator, lights, on-screen maintenance and troubleshooting notifications) | HTI 1 | \$ 389 | Y | Y | Y | Y | Y |
|-----------|---|-------|--------|---|---|---|---|---|

Wall Switch

| | | | | | | | | |
|---------------|---|-------|--------|---|---|---|---|---|
| IFT-RC150-HNG | IntelliFire Touch white wireless wall switch (on/off, cold climate, battery strength indicator) | HNG 1 | \$ 121 | Y | Y | Y | Y | Y |
|---------------|---|-------|--------|---|---|---|---|---|



Battery Back Up



IntelliFire app

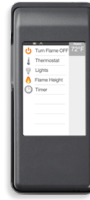

Touch Screen Remote



Wall Switch

Venting

Brick Extension Kit

| | | | | | | | | | |
|--------------|--|-------|----|----|---|----|----|----|---|
| HEAT-OUT-BEK | Exterior Heat-Zone brick extension kit | HTI 1 | \$ | 73 | 8 | 21 | 21 | 14 | Y |
|--------------|--|-------|----|----|---|----|----|----|---|

Venting Notes

Requires 8" DVP pipe. Must have a 24" minimum vertical vent before attaching a 90° elbow to unit. See Venting section.
 Approved for use with PVL P-SLP, PVI-SLP-B and PVV-SLP with power vent wire harness (order separately). See venting section of manual.

TRUE 42 IFT

Includes:

- 30,500 - 55,500 Btu/Hour Input (NG)
- 23,500 - 47,500 Btu/Hour Input (LP)
- RC400 touchscreen remote
- LED accent lighting
- LED illuminated embers
- 8 premium cast logs
- Full brick or black glass refractory
- Gas flex connector
- Intellifire Touch ignition system
- Virtually invisible ceramic glass
- Junction box



Required to Complete - Sold Separately: • Front

| | | Disc. Code | MSRP USD | 004 IA | 010 PA | 014 CA | 016 NC | EXP |
|---------------|---|------------|----------|--------|--------|--------|--------|-----|
| TRUE-42TG-IFT | TRUE 42" Direct Vent Gas Fireplace with Tranquil Greige herringbone refractory (NG) | HNG 2 | \$ 7,609 | Y | Y | Y | 14 | N |
| TRUE-42S-IFT | TRUE 42" Direct Vent Gas Fireplace with Stratford brick refractory (NG) | HNG 2 | \$ 7,669 | 14 | 14 | 14 | 14 | N |
| TRUE-42G-IFT | TRUE 42" Direct Vent Gas Fireplace with Black glass refractory (NG) | HNG 2 | \$ 8,419 | Y | 14 | 14 | 14 | N |

Fronts - Non-Operable (Required to Complete)

Firescreen

| | | | | | | | | |
|-------------|-------------------------------|-------|--------|----|----|----|----|---|
| FS-42IFT-BK | Firescreen front - Black | HNG 2 | \$ 779 | Y | Y | Y | Y | Y |
| FS-42IFT-NB | Firescreen front - New Bronze | HNG 2 | \$ 819 | 14 | 14 | 14 | 21 | Y |
| FS-42IFT-GM | Firescreen front - Gun Metal | HNG 2 | \$ 819 | 14 | 14 | 14 | 14 | Y |

Forge

| | | | | | | | | |
|-------------|--|-------|----------|----|----|----|----|---|
| FORGE-42IFT | Forge, hand-crafted, with forged bars and straps, natural finish | HNG 2 | \$ 2,359 | 14 | 14 | 14 | 21 | N |
|-------------|--|-------|----------|----|----|----|----|---|

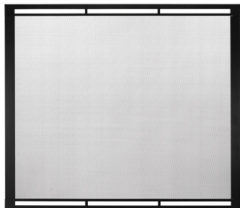

Firescreen



Forge

Fronts - Arched (Required to Complete)

Arched Forge - must include arch kit

| | | | | | | | | |
|--------------|---|-------|----------|----|----|----|----|---|
| FORGE-42AIFT | Arched Forge, hand-crafted, with forged bars and straps, natural finish | HNG 2 | \$ 2,469 | 14 | 14 | 14 | 21 | N |
|--------------|---|-------|----------|----|----|----|----|---|

Firescreen Arch - must include arch kit

| | | | | | | | | |
|--------------|--------------------------------------|-------|--------|----|----|----|----|---|
| FS-42AIFT-BK | Arched Firescreen front - Black | HNG 2 | \$ 839 | 14 | 14 | 14 | 14 | Y |
| FS-42AIFT-NB | Arched Firescreen front - New Bronze | HNG 2 | \$ 889 | 14 | 14 | 14 | 21 | Y |
| FS-42AIFT-GM | Arched Firescreen front - Gun Metal | HNG 2 | \$ 889 | 14 | 14 | 14 | 14 | Y |



Arched Forge

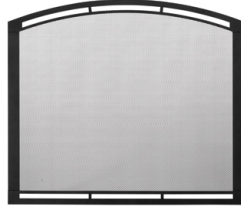

Firescreen Arch

| Arch Kit | | | | | | | | | | |
|---------------------------------|---|-------|----------|----|----|----|----|----|----|---|
| Arch Kit 42 | | | | | | | | | | |
| ARCH-KIT-42 | Arch kit, required for arched fronts | HTI 2 | \$ 329 | 14 | 14 | 14 | 14 | 14 | 14 | Y |
| Conversion Kit | | | | | | | | | | |
| LP Conversion Kit | | | | | | | | | | |
| LPK-TRUE42 | LP conversion kit | HNG 2 | \$ 99 | | 14 | 14 | 14 | 14 | 14 | Y |
| Heat Management | | | | | | | | | | |
| Heat Out Kit | | | | | | | | | | |
| HEAT-OUT-GAS | Heat out kit (includes termination cap, 25' of 6" round duct, fireplace adapter, damper, wall switch and 350CFM fan at termination) | HTI 1 | \$ 1,529 | Y | 14 | Y | 14 | Y | 14 | Y |
| Heat Zone Kit | | | | | | | | | | |
| HEAT-ZONE-GAS | Heat-Zone Kit includes fan, 20' of 6" round duct, vent, wall adapter & on/off control. Wire Plug Assembly 26D0619 required if controlling w/RC400 remote. Used in IFT units with ACM & not a GFK fan. Compatible for up to 2 HEAT-ZONE-GAS kits. See manual. | HTI 1 | \$ 569 | Y | Y | Y | Y | Y | Y | Y |
| Control, remotes, wall switches | | | | | | | | | | |
| Battery Back Up | | | | | | | | | | |
| BATTERY-WSK | Battery backup wall switch kit for units with IFT control systems. Includes: On/Off Wall Switch, USB-C Port, Battery Backup, Cover Plate, 12' Wire Harness | HTI 1 | \$ 189 | Y | 14 | Y | 14 | Y | 14 | Y |
| IntelliFire app | | | | | | | | | | |
| IFT-WFM | IntelliFire Wi-Fi Module that works with the IntelliFire iOS and Android app. Use to control all the features of your fireplace via a smart device. An RC400, RC450 or RC150 is required for thermostat control | HTI 1 | \$ 229 | Y | Y | Y | Y | Y | Y | Y |
| Touch Screen Remote | | | | | | | | | | |
| IFT-RC400 | IntelliFire Touch black remote control, docking station and auxiliary control module (on/off, flame height, thermostat mode, fan control, child lock, cold climate, timer mode, hot indicator, lights, on-screen maintenance and troubleshooting notifications) | HTI 1 | \$ 389 | Y | Y | Y | Y | Y | Y | Y |
| Wall Switch | | | | | | | | | | |
| IFT-RC150-HNG | IntelliFire Touch white wireless wall switch (on/off, cold climate, battery strength indicator) | HNG 1 | \$ 121 | Y | Y | Y | Y | Y | Y | Y |



Battery Back Up



IntelliFire app

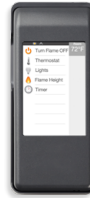

Touch Screen Remote



Wall Switch

Venting

Brick Extension Kit

| | | | | | | | | | |
|--------------|--|-------|----|----|---|----|----|----|---|
| HEAT-OUT-BEK | Exterior Heat-Zone brick extension kit | HTI 1 | \$ | 73 | 8 | 21 | 21 | 14 | Y |
|--------------|--|-------|----|----|---|----|----|----|---|

Venting Notes

Requires 8" DVP pipe. Must have a 24" minimum vertical vent before attaching a 90° elbow to unit (36" for LP). See Venting section.

Approved for use with PVLP-SLP, PVI-SLP-B and PVV-SLP with power vent wire harness (order separately). See venting section of manual.

TRUE 50 IFT

Includes:

- 36,000 - 65,000 Btu/Hour Input (NG)
- 30,250 - 57,500 Btu/Hour Input (LP)
- RC400 touchscreen remote
- LED accent lighting
- LED illuminated embers
- 9 premium cast logs
- Full brick refractory
- Gas flex connector
- IntelliFire Touch ignition system
- Virtually invisible ceramic glass
- Junction box



Required to Complete - Sold Separately: • Front

| | | Disc. Code | MSRP USD | 004 IA | 010 PA | 014 CA | 016 NC | EXP |
|---------------|---|------------|-----------|--------|--------|--------|--------|-----|
| TRUE-50TG-IFT | TRUE 50" Direct Vent Gas Fireplace with Tranquil Greige herringbone refractory (NG) | HNG 2 | \$ 10,509 | Y | 14 | Y | 14 | N |
| TRUE-50S-IFT | TRUE 50" Direct Vent Gas Fireplace with Stratford brick refractory (NG) | HNG 2 | \$ 10,609 | 14 | 14 | 14 | 14 | N |

Fronts - Non-Operable (Required to Complete)

Firescreen

| | | | | | | | | |
|-------------|-------------------------------|-------|--------|----|----|----|----|---|
| FS-50IFT-BK | Firescreen front - Black | HNG 2 | \$ 919 | Y | 14 | Y | 21 | N |
| FS-50IFT-GM | Firescreen front - Gun Metal | HNG 2 | \$ 959 | 14 | 14 | 14 | 14 | Y |
| FS-50IFT-NB | Firescreen front - New Bronze | HNG 2 | \$ 959 | 14 | 14 | 14 | 21 | Y |

Forge

| | | | | | | | | |
|-------------|--|-------|----------|----|----|----|----|---|
| FORGE-50IFT | Forge, hand-crafted, with forged bars and straps, natural finish | HNG 2 | \$ 2,829 | 14 | 14 | 14 | 21 | N |
|-------------|--|-------|----------|----|----|----|----|---|

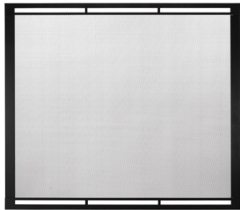

Firescreen

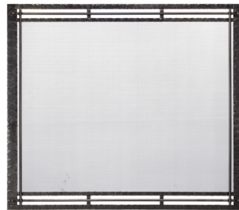

Forge

Fronts - Arched (Required to Complete)

Arched Forge - must include arch kit

| | | | | | | | | |
|--------------|---|-------|----------|----|----|----|----|---|
| FORGE-50AIFT | Arched Forge, hand-crafted, with forged bars and straps, natural finish | HNG 2 | \$ 2,949 | 14 | 14 | 14 | 21 | N |
|--------------|---|-------|----------|----|----|----|----|---|

Firescreen Arch - must include arch kit

| | | | | | | | | |
|--------------|--------------------------------------|-------|----------|----|----|----|----|---|
| FS-50AIFT-BK | Arched Firescreen front - Black | HNG 2 | \$ 979 | 14 | 14 | 14 | 21 | Y |
| FS-50AIFT-NB | Arched Firescreen front - New Bronze | HNG 2 | \$ 1,019 | 14 | 14 | 14 | 21 | Y |
| FS-50AIFT-GM | Arched Firescreen front - Gun Metal | HNG 2 | \$ 1,019 | 14 | 14 | 14 | 14 | Y |



Arched Forge

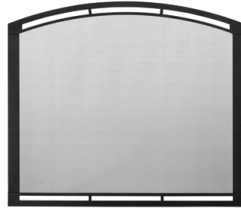

Firescreen Arch

| Arch Kit | | | | | | | | | | |
|---------------------------------|---|-------|----|-------|----|----|----|----|----|---|
| Arch Kit 50 | | | | | | | | | | |
| ARCH-KIT-50 | Arch kit, required for arched fronts | HTI 2 | \$ | 389 | 14 | 21 | 14 | 14 | 14 | Y |
| Conversion Kit | | | | | | | | | | |
| LP Conversion Kit | | | | | | | | | | |
| LPK-TRUE50 | LP conversion kit | HNG 2 | \$ | 239 | | 21 | 14 | 14 | 14 | Y |
| Heat Management | | | | | | | | | | |
| Heat Out Kit | | | | | | | | | | |
| HEAT-OUT-GAS | Heat out kit (includes termination cap, 25' of 6" round duct, fireplace adapter, damper, wall switch and 350CFM fan at termination) | HTI 1 | \$ | 1,529 | Y | 14 | Y | 14 | Y | Y |
| Heat Zone Kit | | | | | | | | | | |
| HEAT-ZONE-GAS | Heat-Zone Kit includes fan, 20' of 6" round duct, vent, wall adapter & on/off control. Wire Plug Assembly 26D0619 required if controlling w/RC400 remote. Used in IFT units with ACM & not a GFK fan. Compatible for up to 2 HEAT-ZONE-GAS kits. See manual. | HTI 1 | \$ | 569 | Y | Y | Y | Y | Y | Y |
| Control, remotes, wall switches | | | | | | | | | | |
| Battery Back Up | | | | | | | | | | |
| BATTERY-WSK | Battery backup wall switch kit for units with IFT control systems. Includes: On/Off Wall Switch, USB-C Port, Battery Backup, Cover Plate, 12' Wire Harness | HTI 1 | \$ | 189 | Y | 14 | Y | 14 | Y | Y |
| IntelliFire app | | | | | | | | | | |
| IFT-WFM | IntelliFire Wi-Fi Module that works with the IntelliFire iOS and Android app. Use to control all the features of your fireplace via a smart device. An RC400, RC450 or RC150 is required for thermostat control | HTI 1 | \$ | 229 | Y | Y | Y | Y | Y | Y |
| Touch Screen Remote | | | | | | | | | | |
| IFT-RC400 | IntelliFire Touch black remote control, docking station and auxiliary control module (on/off, flame height, thermostat mode, fan control, child lock, cold climate, timer mode, hot indicator, lights, on-screen maintenance and troubleshooting notifications) | HTI 1 | \$ | 389 | Y | Y | Y | Y | Y | Y |
| Wall Switch | | | | | | | | | | |
| IFT-RC150-HNG | IntelliFire Touch white wireless wall switch (on/off, cold climate, battery strength indicator) | HNG 1 | \$ | 121 | Y | Y | Y | Y | Y | Y |



Battery Back Up



IntelliFire app

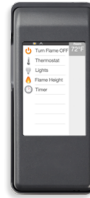

Touch Screen Remote



Wall Switch

Venting

Brick Extension Kit

| | | | | | | | | | |
|--------------|--|-------|----|----|---|----|----|----|---|
| HEAT-OUT-BEK | Exterior Heat-Zone brick extension kit | HTI 1 | \$ | 73 | 8 | 21 | 21 | 14 | Y |
|--------------|--|-------|----|----|---|----|----|----|---|

Venting Notes

Requires 8" DVP pipe. Must have a 24" minimum vertical vent before attaching a 90° elbow to unit. See Venting section.
 Approved for use with PVL-PSLP, PVI-SLP-B and PVV-SLP with power vent wire harness (order separately). See venting section of manual.

| | | |
|-------------------------|-------------------------------------|---|
| <h1>Heat & Glo</h1> | <h2>Fireplace - Gas - TrueView</h2> | Stocked Item/Lead Time 004=Mt. Pleasant RDC 010=Kutztown RDC 014=Sacramento RDC 016=Charlotte RDC EXP=Factory Expedite Program |
|-------------------------|-------------------------------------|---|

Prices in USD

Page printed 3/31/2025, 8:22:26 AM CDT
 Current pricing updated 03/30/2025
 * Please Contact Who You Purchase This Through for MSRP Pricing

Non-stock and custom product cannot be cancelled.

Customer is responsible for freight for orders made outside of assigned RDC facility.

Phoenix 42

Includes:

- No glass - 42" x 28 1/2" opening
- 65,000 Btu/Hour input (NG)
- 65,000 Btu/Hour input (LP)
- Power vent termination cap
- Exterior wall firestop/damper
- Ember lights
- RC400 remote control
- IntelliFire Touch control system
- Molded fiber burner
- Gas flex connector
- Junction box
- 2 optional outside air hook ups
- glowing embers
- Square steel grate
- Safety firescreen



Special Considerations:

- Advanced Technology Product training required before product ships
- Not available in Canada

Required to Complete - Sold Separately:

- Hearth Kit (includes logs, refractory, base filler pieces)
- Wire Harness

| | | Disc. Code | MSRP USD | 004 IA | 010 PA | 014 CA | 016 NC | EXP |
|---------------|---|------------|----------|--------|--------|--------|--------|-----|
| PHOENIX42-IFT | Phoenix 42" top/rear TrueView gas fireplace powered by WhisperTone technology with Intellifire Touch ignition system (NG)(Includes horizontal termination cap and wall fire stop) | HNG 3 | \$ 5,869 | Y | Y | 14 | 14 | N |

Hearth Kit (Required to Complete)

Hearth Kit

| | | | | | | | | |
|----------------|--|-------|----------|---|----|----|----|---|
| PHX42-HK-TR-B | Traditional style fiber brick refractory, high definition logs, molded fiber base front and side trim pieces | HNG 3 | \$ 2,449 | Y | 14 | 14 | 14 | N |
| PHX42-HK-GLA-B | Reflective black glass refractory, high definition logs, molded fiber base front and side trim pieces | HNG 3 | \$ 3,039 | 8 | 14 | 14 | 14 | N |

Wire Harness (Required to Complete)

TrueView Wire Harness

| | | | | | | | | |
|---------|-----------------------------|-------|--------|----|----|----|----|---|
| TV-WH10 | TrueView wire harness - 10' | HTI 1 | \$ 131 | Y | Y | Y | 14 | Y |
| TV-WH25 | TrueView wire harness - 25' | HTI 1 | \$ 183 | Y | Y | Y | 14 | Y |
| TV-WH50 | TrueView wire harness - 50' | HTI 1 | \$ 238 | 21 | 21 | 21 | 21 | Y |

Conversion Kit

Conversion Kit

| | | | | | | | | |
|--------|---------------------------------|-------|-------|---|----|----|----|---|
| NGK-OH | NG Conversion Kit - TrueView 42 | HHR 1 | \$ 99 | 8 | 14 | 14 | 14 | Y |
| LPK-OH | LP conversion kit - 42 TrueView | HTI 1 | \$ 99 | Y | Y | 14 | 14 | Y |

Mesh Doors - Operable

Grand Vista 80

| | | | | | | | | |
|--------|--|-------|----------|---|----|----|----|---|
| GV80BK | Grand Vista cabinet style mesh doors - Black | HTI 1 | \$ 1,449 | Y | 14 | 14 | 14 | N |
|--------|--|-------|----------|---|----|----|----|---|

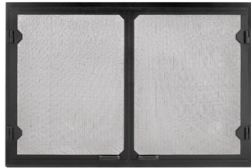

Grand Vista 80

Options & Accessories

Speaker Kit (Optional - not required to complete)

| | | | | | | | | |
|-------------|---|-------|--------|---|----|----|----|---|
| SPEAKER-KIT | Speaker's (2) and blue tooth amplifier system | HNG 1 | \$ 539 | 8 | 14 | 14 | 21 | Y |
|-------------|---|-------|--------|---|----|----|----|---|

Control, remotes, wall switches

IntelliFire app

| | | | | | | | | |
|---------|---|-------|--------|---|---|---|---|---|
| IFT-WFM | IntelliFire Wi-Fi Module that works with the IntelliFire iOS and Android app. Use to control all the features of your fireplace via a smart device. An RC400, RC450 or RC150 is required for thermostat control | HTI 1 | \$ 229 | Y | Y | Y | Y | Y |
|---------|---|-------|--------|---|---|---|---|---|



IntelliFire app

Venting

DVP Components-SinglePk - Firestop/Straps/Support

| | | | | | | | | |
|---------|-------------------------|-------|-------|---|---|----|----|---|
| DVP-HVS | Horizontal pipe support | HTI 1 | \$ 50 | Y | Y | 14 | 14 | Y |
| DVP-WS | Wall Firestop | HTI 1 | \$ 96 | Y | Y | Y | Y | Y |

DVP Components-SinglePk - Shield/Flashing/Collars

| | | | | | | | | |
|----------|---|-------|-------|---|---|---|---|---|
| UNIV-AS2 | Attic insulation shield (firestop not included) | HTI 1 | \$ 54 | Y | Y | Y | Y | Y |
|----------|---|-------|-------|---|---|---|---|---|

Insulated Flex Duct - Chimney Air Kits/Flex Duct

| | | | | | | | | |
|-----|---|-------|-------|---|---|----|---|---|
| ID4 | 4" (100mm) insulated flex duct for outside air - includes two 42" (1065mm) sections | HTI 1 | \$ 87 | Y | Y | 14 | Y | Y |
|-----|---|-------|-------|---|---|----|---|---|

Outside Air Kit

| | | | | | | | | |
|------|---------------------------------------|-------|-------|---|---|---|---|---|
| AK22 | Outside air kit - (flex not included) | HTI 1 | \$ 70 | Y | Y | Y | Y | Y |
|------|---------------------------------------|-------|-------|---|---|---|---|---|

Uninsulated Flex Duct - Chimney Air Kits/Flex Duct

| | | | | | | | | |
|-----|---|-------|-------|---|---|---|---|---|
| UD4 | 4" (100mm) uninsulated flex duct for outside air - includes two 42" (1065mm) sections | HTI 1 | \$ 56 | Y | Y | Y | Y | Y |
|-----|---|-------|-------|---|---|---|---|---|

| Snap Lock Gas Venting - Straight Pipe | | | | | | | | | | |
|---------------------------------------|--|-------|----|-----|---|---|----|----|----|---|
| SLG4 | Snap Lock Gas 4" pipe section | HTI 1 | \$ | 61 | Y | Y | 14 | 14 | Y | |
| SLG6 | Snap Lock Gas 6" pipe section | HTI 1 | \$ | 70 | Y | Y | 14 | 14 | Y | |
| SLG6A | Snap Lock Gas 2" - 4.5" adjustable pipe section | HTI 1 | \$ | 75 | Y | | 14 | 14 | 14 | Y |
| SLG12 | Snap Lock Gas 12" pipe section | HTI 1 | \$ | 76 | Y | Y | 14 | Y | Y | |
| SLG12A | Snap Lock Gas 2" - 10.5" adjustable pipe section | HTI 1 | \$ | 80 | Y | Y | 14 | Y | Y | |
| SLG24 | Snap Lock Gas 24" pipe section | HTI 1 | \$ | 105 | Y | | 14 | 14 | Y | Y |
| SLG36 | Snap Lock Gas 36" pipe section | HTI 1 | \$ | 117 | Y | Y | 14 | 14 | Y | |
| SLG48 | Snap Lock Gas 48" pipe section | HTI 1 | \$ | 137 | Y | Y | Y | Y | Y | |

| Snap Lock Gas Venting - Components | | | | | | | | | | |
|------------------------------------|--|-------|----|----|---|--|----|----|----|---|
| SLG-FS | Snap Lock Gas ceiling firestop | HTI 1 | \$ | 61 | Y | | 14 | 14 | 14 | Y |
| SLG-D-EXT | SLG damper extension; For use when finish wall depth is between 7" to 30" thick; DVP-HSM-B is also required and ordered separately | HTI 1 | \$ | 68 | Y | | 21 | 14 | 14 | Y |
| SLG-BEK | SLG power vent cap brick extension 14" x 16" | HTI 1 | \$ | 76 | Y | | 14 | 14 | 14 | Y |

| Snap Lock Gas Venting - Elbow | | | | | | | | | | |
|-------------------------------|-------------------------|-------|----|-----|---|---|----|---|---|--|
| SLG45 | Snap Lock Gas 45' elbow | HTI 1 | \$ | 98 | Y | Y | 14 | Y | Y | |
| SLG90 | Snap Lock Gas 90' elbow | HTI 1 | \$ | 105 | Y | Y | 14 | Y | Y | |

| Venting Notes | | | | | | | | | | |
|--|--|--|--|--|--|--|--|--|--|--|
| Uses 8" Snap Lock Gas (SLG) venting with some DVP components. See venting section in manual. | | | | | | | | | | |
| Can be vented off the top or rear of the unit. | | | | | | | | | | |
| Must terminate horizontally. | | | | | | | | | | |
| UL/ULC listed. | | | | | | | | | | |

Heat & Glo

Fireplace - Gas - Freestanding

Stocked Item/Lead Time
 004=Mt. Pleasant RDC
 010=Kutztown RDC
 014=Sacramento RDC
 016=Charlotte RDC
 EXP=Factory Expedite Program

Prices in USD

Page printed 3/31/2025, 8:22:26 AM CDT
 Current pricing updated 03/30/2025
 * Please Contact Who You Purchase This Through for MSRP Pricing

Non-stock and custom product cannot be cancelled.
 Customer is responsible for freight for orders made outside of assigned RDC facility.

Supreme Freestanding 30"

- Includes:
- 22,890 - 32,700 BTU/Hour Input (NG)
 - 22,400 - 32,000 BTU/Hour Input (LP)
 - IntelliFire Touch Ignition System
 - RC400 Remote Control
 - GFK-160A Variable Fan
 - Ceramic Glass
 - Glowing Embers/Mystic Embers
 - Battery Back Up
 - Electrical Cord - 10' 3" Left
 - Gas Flex Connector
 - 5 Ceramic Fiber Logs



- Special Considerations:
- BIR unit requires LP conversion, order LPK-MI-IFT
 - Must order 2532-301 (USB-C plug & Bracket from service parts list) to use battery back up

- Required to Complete - Sold Separately:
- INFIT-30-BK
 - ADP-CK Adapter kit
 - CK-30 Cabinet kit

| | | Disc. Code | MSRP USD | 004 IA | 010 PA | 014 CA | 016 NC | EXP |
|-----------------|--|------------|----------|--------|--------|--------|--------|-----|
| SUPREME-I30-IFT | Medium 30" direct vent gas fireplace insert with intellifire touch system (NG) | HNG 3 | \$ 2,969 | Y | Y | Y | Y | N |
| SUPRM-I30LP-IFT | Medium 30" direct vent gas fireplace insert with intellifire touch system (LP) | HNG 3 | \$ 3,039 | Y | Y | Y | 14 | N |
| SUPREME-I30-BIR | Medium 30" direct vent gas fireplace insert with intellifire touch system (NG) | HNG 3 | \$ 3,169 | Y | Y | Y | 14 | N |

Fronts - Non-Operable (Required to Complete)

Inside Fit

| | | | | | | | | |
|-------------|-------------------------------------|-------|--------|---|---|---|----|---|
| INFIT-30-BK | Inside fit 30" screen front - Black | HTI 3 | \$ 369 | Y | Y | Y | 14 | Y |
|-------------|-------------------------------------|-------|--------|---|---|---|----|---|



Inside Fit

Cabinet (Required to Complete)

Cabinet - Steel

| | | | | | | | | |
|-------|---|-------|----------|---|---|---|----|---|
| CK-30 | Steel cabinet with pedestal base for use with 30" gas inserts | HTI 3 | \$ 1,029 | Y | Y | Y | 14 | N |
|-------|---|-------|----------|---|---|---|----|---|

| Venting (Required to Complete) | | | | | | | | | |
|---------------------------------|---|-------|----|-----|---|---|---|----|---|
| Adaptor | | | | | | | | | |
| ADP-CK30 | Adapter kit (required for use with CK-30) | HTI 3 | \$ | 221 | Y | Y | Y | 14 | Y |
| Conversion Kit | | | | | | | | | |
| Conversion Kit | | | | | | | | | |
| LPK-MI-IFT | LP conversion kit for metal insert with IntelliFire Touch | HTI 3 | \$ | 0 | | Y | Y | Y | Y |
| Lighting | | | | | | | | | |
| Accent Light Kit | | | | | | | | | |
| MI-ALK | Ambient Light Kit (not for use in 25" models) (Not recommended for use with Reflective Black Glass Liner) | HTI 3 | \$ | 499 | Y | Y | Y | 14 | Y |
| Liner Kit | | | | | | | | | |
| Glass Liner | | | | | | | | | |
| LINER-BK-30 | Reflective Black Glass Liner 30" traditional units | HTI 3 | \$ | 549 | Y | Y | Y | 14 | Y |
| Refractory Upgrade | | | | | | | | | |
| Fiber Refractory | | | | | | | | | |
| BRICK-MI30-TR | Traditional 30" Brick interior panels - Stratford | HNG 3 | \$ | 299 | Y | Y | Y | 14 | Y |
| Fiber Refractory | | | | | | | | | |
| BRICK-MI30-HB | Herringbone 30" Brick interior panels - Tranquil Greige | HNG 3 | \$ | 329 | Y | Y | Y | 14 | Y |
| Control, remotes, wall switches | | | | | | | | | |
| IntelliFire app | | | | | | | | | |
| IFT-WFM | IntelliFire Wi-Fi Module that works with the IntelliFire iOS and Android app. Use to control all the features of your fireplace via a smart device. An RC400, RC450 or RC150 is required for thermostat control | HTI 1 | \$ | 229 | Y | Y | Y | Y | Y |
| Touch Screen Remote | | | | | | | | | |
| IFT-RC400 | IntelliFire Touch black remote control, docking station and auxiliary control module (on/off, flame height, thermostat mode, fan control, child lock, cold climate, timer mode, hot indicator, lights, on-screen maintenance and troubleshooting notifications) | HTI 1 | \$ | 389 | Y | Y | Y | Y | Y |
| Wall Switch | | | | | | | | | |
| IFT-RC150-HNG | IntelliFire Touch white wireless wall switch (on/off, cold climate, battery strength indicator) | HNG 1 | \$ | 121 | Y | Y | Y | Y | Y |



IntelliFire app



Touch Screen Remote



Wall Switch

Venting Notes
 SLP Pipe. Appliance ship with SLP starting collar. DuraVent pipe, purchase STOVEDV-BK starting collar. ICC pipe, purchase STOVEICC-BK adapter.

Heat & Glo

Fireplace - Gas - Multi-Sided

Stocked Item/Lead Time
 004=Mt. Pleasant RDC
 010=Kutztown RDC
 014=Sacramento RDC
 016=Charlotte RDC
 EXP=Factory Expedite Program

Prices in USD

Page printed 3/31/2025, 8:22:26 AM CDT
 Current pricing updated 03/30/2025
 * Please Contact Who You Purchase This Through for MSRP Pricing

Non-stock and custom product cannot be cancelled.
 Customer is responsible for freight for orders made outside of assigned RDC facility.

Escape See-Through IFT

Includes:

- 43,500 - 57,500 Btu/Hour Input (NG)
- 41,000 - 56,500 Btu/Hour Input (LP)
- RC400 touchscreen remote
- Accent lights
- Electric ember bed
- 9 ceramic fiber logs
- Stratford brick refractory
- Gas flex connector
- IntelliFire Touch ignition system
- Virtually invisible ceramic glass
- Battery backup
- Non-combustible board
- Junction box
- Glowing embers



Required to Complete - Sold Separately: • 2 Fronts

| | | Disc. Code | MSRP USD | 004 IA | 010 PA | 014 CA | 016 NC | EXP |
|--------------|---|------------|-----------|--------|--------|--------|--------|-----|
| ESC-42ST-IFT | Escape-ST 42" See-Through Direct Vent Gas Fireplace top vent clean face unit with IntelliFire Touch Ignition (NG) | HNG 2 | \$ 10,209 | Y | Y | Y | 14 | N |

Fronts - Non-Operable (Required to Complete)

Firescreen

| | | | | | | | | |
|---------------|-------------------------------|-------|--------|----|----|----|----|---|
| FS-42STIFT-BK | Firescreen Front - Black | HNG 2 | \$ 769 | Y | Y | Y | 21 | Y |
| FS-42STIFT-NB | Firescreen Front - New Bronze | HNG 2 | \$ 809 | 14 | 14 | 14 | 21 | Y |
| FS-42STIFT-GM | Firescreen front - Gun Metal | HNG 1 | \$ 809 | 14 | 14 | 14 | 14 | Y |



Firescreen

Fronts - Arched (Required to Complete)

Firescreen Arch - must include arch kit

| | | | | | | | | |
|----------------|---|-------|--------|----|----|----|----|---|
| FSA-42STIFT-BK | Arched Firescreen front - must install ARCHKIT-ESC42ST - Black | HNG 2 | \$ 829 | Y | 14 | 14 | 21 | Y |
| FSA-42STIFT-GM | Arched Firescreen front - must install ARCHKIT-ESC42ST - Gun Metal | HNG 1 | \$ 869 | 14 | 14 | 14 | 14 | Y |
| FSA-42STIFT-NB | Arched Firescreen front - must install ARCHKIT-ESC42ST - New Bronze | HNG 2 | \$ 869 | 14 | 14 | 14 | 21 | Y |



Firescreen Arch

| Arch Kit | | | | | | | | | | |
|----------------------|--------------------------------------|-------|----|-----|----|----|----|----|---|--|
| Arched Finishing Kit | | | | | | | | | | |
| ARCHKIT-ESC42ST | Arched finishing kit - one side only | HNG 1 | \$ | 479 | 14 | 14 | 14 | 14 | Y | |

| Andirons | | | | | | | | | | |
|-------------|--|-------|----|-----|---|----|----|----|---|--|
| Andirons | | | | | | | | | | |
| ANDIRON-ESC | Andiron (qty 2) - order two sets to complete | HNG 2 | \$ | 299 | 8 | 21 | 14 | 14 | Y | |



Andirons

| Conversion Kit | | | | | | | | | | |
|-----------------|-------------------|-------|----|----|--|----|----|----|---|--|
| Conversion Kits | | | | | | | | | | |
| LPKMARQ42ST | LP conversion kit | HTI 1 | \$ | 99 | | 21 | 14 | 14 | Y | |

| Heat Management | | | | | | | | | | |
|-----------------|---|-------|----|-------|---|----|---|----|---|--|
| Heat Out Kit | | | | | | | | | | |
| HEAT-OUT-GAS | Heat out kit (includes termination cap, 25' of 6" round duct, fireplace adapter, damper, wall switch and 350CFM fan at termination) | HTI 1 | \$ | 1,529 | Y | 14 | Y | 14 | Y | |

| Heat Zone Kit | | | | | | | | | | |
|---------------|--|-------|----|-----|---|---|---|---|---|--|
| HEAT-ZONE-GAS | Heat-Zone Kit includes fan, 20' of 6" round duct, vent, wall adapter & on/off control. Wire Plug Assembly 26D0619 required if controlling w/RC400 remote. Used in IFT units with ACM & not a GFK fan. Compatible for up to 2 HEAT-ZONE-GAS kits. See manual. | HTI 1 | \$ | 569 | Y | Y | Y | Y | Y | |

| Control, remotes, wall switches | | | | | | | | | | |
|---------------------------------|--|-------|----|-----|---|----|---|----|---|--|
| Battery Back Up | | | | | | | | | | |
| BATTERY-WSK | Battery backup wall switch kit for units with IFT control systems. Includes: On/Off Wall Switch, USB-C Port, Battery Backup, Cover Plate, 12' Wire Harness | HTI 1 | \$ | 189 | Y | 14 | Y | 14 | Y | |

| IntelliFire app | | | | | | | | | | |
|-----------------|---|-------|----|-----|---|---|---|---|---|--|
| IFT-WFM | IntelliFire Wi-Fi Module that works with the IntelliFire iOS and Android app. Use to control all the features of your fireplace via a smart device. An RC400, RC450 or RC150 is required for thermostat control | HTI 1 | \$ | 229 | Y | Y | Y | Y | Y | |

Touch Screen Remote

| | | | | | | | | |
|-----------|---|-------|--------|---|---|---|---|---|
| IFT-RC400 | IntelliFire Touch black remote control, docking station and auxiliary control module (on/off, flame height, thermostat mode, fan control, child lock, cold climate, timer mode, hot indicator, lights, on-screen maintenance and troubleshooting notifications) | HTI 1 | \$ 389 | Y | Y | Y | Y | Y |
|-----------|---|-------|--------|---|---|---|---|---|

Wall Switch

| | | | | | | | | |
|---------------|---|-------|--------|---|---|---|---|---|
| IFT-RC150-HNG | IntelliFire Touch white wireless wall switch (on/off, cold climate, battery strength indicator) | HNG 1 | \$ 121 | Y | Y | Y | Y | Y |
|---------------|---|-------|--------|---|---|---|---|---|



Battery Back Up



IntelliFire app



Touch Screen Remote



Wall Switch

Venting

Brick Extension Kit

| | | | | | | | | |
|--------------|--|-------|-------|---|----|----|----|---|
| HEAT-OUT-BEK | Exterior Heat-Zone brick extension kit | HTI 1 | \$ 73 | 8 | 21 | 21 | 14 | Y |
|--------------|--|-------|-------|---|----|----|----|---|

Venting Notes

Requires 8" DVP pipe. Must have a 24" minimum vertical vent before attaching a 90° elbow to unit. See Venting section.
 Approved for use with PVLP-SLP, PVI-SLP-B and PVV-SLP and power vent wire harness (order separately) and IFT-RC400 remote. See venting section of manual.

MEZZO 36 See-Through

Includes:

- 17,500 - 30,000 Btu/Hour Input(NG)
- 15,500 - 29,000 Btu/Hour Input (LP)
- Clear LED dimmable lights
- Black glass refractory
- RC400 Remote Control
- Ceramic Glass
- Junction box
- Gas flex connector
- Battery backup
- IntelliFire Touch ignition system
- Not available for sale in Rhode Island



Special Considerations:

- If installing driftwood log set & river rock stones, only 1 stone set can be used
- If installing only river rock stones, 2 sets can be used

Required to Complete - Sold Separately: • 2 Fronts • Crushed Glass Media

| | | Disc. Code | MSRP USD | 004 IA | 010 PA | 014 CA | 016 NC | EXP |
|-------------|---|------------|----------|--------|--------|--------|--------|-----|
| MEZZO36ST-C | MEZZO 36ST top direct vent fireplace with IntelliFire Touch Ignition (NG) | HNG 1 | \$ 6,559 | 14 | 14 | 14 | 14 | N |

Fronts - Non-Operable (Required to Complete)

Clean Face Trim

| | | | | | | | | |
|-------------|-----------------------------------|-------|--------|----|----|----|----|---|
| CFT-36-BK-C | Clean face trim - Black | HTI 1 | \$ 439 | Y | Y | Y | Y | Y |
| CFT-36-NB-C | Clean Face Trim - New Bronze | HTI 1 | \$ 489 | 14 | 14 | 14 | 14 | Y |
| CFT-36-GM-C | Clean face trim - Gun Metal | HTI 1 | \$ 489 | 14 | 14 | 14 | 14 | Y |
| CFT-36-SS-C | Clean face trim - Stainless Steel | HTI 1 | \$ 749 | 14 | 14 | 14 | 14 | Y |

Loft Forge 36

| | | | | | | | | |
|--------------|--|-------|----------|----|----|----|----|---|
| LOFTFORGE-36 | Loft Forge hand-crafted front. Max finishing material depth = 1" | HNG 1 | \$ 1,389 | 14 | 14 | 14 | 14 | N |
|--------------|--|-------|----------|----|----|----|----|---|

Quattro 36

| | | | | | | | | |
|----------|----------------------------|-------|--------|----|----|----|----|---|
| QT-36-BK | Quattro front - Black | HNG 1 | \$ 759 | 14 | 14 | 14 | 14 | N |
| QT-36-NB | Quattro front - New Bronze | HNG 1 | \$ 799 | 14 | 14 | 14 | 14 | N |



Clean Face Trim



Loft Forge 36



Quattro 36

Media (Required to Complete)

Crushed Glass Media

| | | | | | | | | |
|-----------------|--|-------|--------|----|----|----|----|---|
| MEDIA-CLEAR-36 | Glass media, crystal (translucent white) | HTI 1 | \$ 129 | Y | Y | Y | 14 | Y |
| MEDIA-RED-36 | Glass media, scarlet (red) | HTI 1 | \$ 259 | 14 | 21 | 14 | 14 | Y |
| MEDIA-EBONY-36 | Glass media, ebony (black) | HTI 1 | \$ 259 | Y | 21 | 14 | 14 | Y |
| MEDIA-FOG-36 | Iced fog media (requires black spray paint finish) | HNG 1 | \$ 259 | Y | 21 | Y | 14 | Y |
| MEDIA-AMBER-36 | Glass media, amber | HTI 1 | \$ 259 | 14 | 21 | 14 | 14 | Y |
| MEDIA-COBALT-36 | Glass media, cobalt (blue) | HTI 1 | \$ 259 | 14 | 21 | 14 | 14 | Y |

| MEDIA | | | | | | | | | | |
|---------------------------------|--|-------|----|-------|----|----|----|----|---|--|
| STONES-36 | River Rock Stone Set (requires media) | HNG 1 | \$ | 129 | Y | 28 | 21 | 28 | Y | |
| Conversion Kit | | | | | | | | | | |
| Conversion Kit | | | | | | | | | | |
| LPK-4836 | LP conversion kit | HTI 1 | \$ | 99 | Y | Y | 14 | Y | Y | |
| NGK-MC-C | NG Conversion Kit | HTI 1 | \$ | 99 | 14 | 14 | 14 | 14 | Y | |
| Gas Logs - Log Set Option | | | | | | | | | | |
| Driftwood Log Set | | | | | | | | | | |
| DRIFTLOGS-36 | Driftwood Log Set (requires media) | HNG 1 | \$ | 399 | 21 | 14 | 14 | 14 | Y | |
| Natural Log Set | | | | | | | | | | |
| LOGS-36 | Natural Log set (requires media) | HTI 1 | \$ | 279 | 14 | 14 | 14 | 14 | Y | |
| Options & Accessories | | | | | | | | | | |
| Options & Accessories | | | | | | | | | | |
| ST36-CFP | Light baffle kit. Recommended for use when two CFT fronts are being installed. | HTI 1 | \$ | 99 | 14 | 21 | 14 | 14 | Y | |
| Heat Management | | | | | | | | | | |
| Heat Management | | | | | | | | | | |
| PH-SIDETRIM | Passive Heat trim kit for side discharge (includes 2 side registers)(Starting collars sold separately) | HTI 1 | \$ | 110 | Y | Y | Y | Y | Y | |
| PH-MCE | Starting Collars for Non-Ducted Passive Heat (Required when using passive heat - For use with Front, Side, Top Discharges) | HTI 1 | \$ | 179 | Y | Y | Y | Y | Y | |
| PH-FRTRIM-36 | Passive Heat Vent Trim Kit For Front Discharge (36")(Starting collars sold separately) | HTI 1 | \$ | 209 | Y | Y | Y | 21 | Y | |
| Heat Management - Ducted | | | | | | | | | | |
| PHTRIM-MCE-36 | Ducted vent trim for front discharge using ducted Passive Heat (PHFR-MCE-36) | HTI 1 | \$ | 249 | 14 | 14 | 14 | 14 | Y | |
| PHSI-MCE | Ducted Passive Heat kit for side discharge (includes duct and 2 side registers) | HTI 1 | \$ | 569 | 14 | 21 | 14 | 14 | Y | |
| PHFR-MCE-36 | Ducted Passive Heat kit for front discharge (requires PHTRIM-MCE-36 front trim) | HTI 1 | \$ | 629 | 14 | 14 | 14 | 14 | Y | |
| Heat Out Kit | | | | | | | | | | |
| HEAT-OUT-GAS | Heat out kit (includes termination cap, 25' of 6" round duct, fireplace adapter, damper, wall switch and 350CFM fan at termination) | HTI 1 | \$ | 1,529 | Y | 14 | Y | 14 | Y | |
| Heat Zone Kit | | | | | | | | | | |
| HZLIN-ADP | Heat Zone adaptor, must order for using HEAT-ZONE-GAS | HTI 1 | \$ | 179 | Y | Y | Y | 14 | Y | |
| HEAT-ZONE-GAS | Heat-Zone Kit includes fan, 20' of 6" round duct, vent, wall adapter & on/off control. Wire Plug Assembly 26D0619 required if controlling w/RC400 remote. Used in IFT units with ACM & not a GFK fan. Compatible for up to 2 HEAT-ZONE-GAS kits. See manual. | HTI 1 | \$ | 569 | Y | Y | Y | Y | Y | |
| Control, remotes, wall switches | | | | | | | | | | |
| Battery Back Up | | | | | | | | | | |
| BATTERY-WSK | Battery backup wall switch kit for units with IFT control systems. Includes: On/Off Wall Switch, USB-C Port, Battery Backup, Cover Plate, 12' Wire Harness | HTI 1 | \$ | 189 | Y | 14 | Y | 14 | Y | |

| IntelliFire app | | | | | |
|---------------------|---|-------|--------|---|---|
| IFT-WFM | IntelliFire Wi-Fi Module that works with the IntelliFire iOS and Android app. Use to control all the features of your fireplace via a smart device. An RC400, RC450 or RC150 is required for thermostat control | HTI 1 | \$ 229 | Y | Y |
| Touch Screen Remote | | | | | |
| IFT-RC400 | IntelliFire Touch black remote control, docking station and auxiliary control module (on/off, flame height, thermostat mode, fan control, child lock, cold climate, timer mode, hot indicator, lights, on-screen maintenance and troubleshooting notifications) | HTI 1 | \$ 389 | Y | Y |
| Wall Switch | | | | | |
| IFT-RC150-HNG | IntelliFire Touch white wireless wall switch (on/off, cold climate, battery strength indicator) | HNG 1 | \$ 121 | Y | Y |



Battery Back Up



IntelliFire app

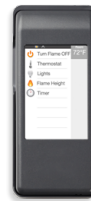

Touch Screen Remote



Wall Switch

Venting

Brick Extension Kit

| | | | | | | | | |
|--------------|--|-------|-------|---|----|----|----|---|
| HEAT-OUT-BEK | Exterior Heat-Zone brick extension kit | HTI 1 | \$ 73 | 8 | 21 | 21 | 14 | Y |
|--------------|--|-------|-------|---|----|----|----|---|

Venting Notes

Requires 8" DVP pipe. Must have 18" minimum vertical before attaching a 90 degree elbow to the unit. See Venting section.
 Approved for use with PVL-PSL, PVI-PSL-B and PVV-PSL with power vent wire harness (order separately) and IFT-RC400 remote. See venting section of manual.

MEZZO 48 See-Through

Includes:

- 21,000 - 40,000 Btu/Hour Input (NG)
- 19,500 - 36,000 Btu/Hour Input (LP)
- Clear LED dimmable lights
- Black glass refractory
- RC400 Remote Control
- Ceramic Glass
- Junction box
- Gas flex connector
- Battery backup
- IntelliFire Touch ignition system



Special Considerations:

- If installing driftwood log set & river rock stones, only 1 stone set can be used
- If installing only river rock stones, 2 sets can be used

Required to Complete - Sold Separately: • 2 Fronts • Crushed Glass Media

| | | Disc. Code | MSRP USD | 004 IA | 010 PA | 014 CA | 016 NC | EXP |
|-------------|---|------------|----------|--------|--------|--------|--------|-----|
| MEZZO48ST-C | MEZZO 48ST top direct vent fireplace with IntelliFire Touch Ignition (NG) | HNG 1 | \$ 7,809 | 14 | 14 | 14 | 14 | N |

Fronts - Non-Operable (Required to Complete)

Clean Face Trim

| | | | | | | | | |
|-------------|-----------------------------------|-------|--------|----|----|----|----|---|
| CFT-48-BK-C | Clean face trim - Black | HTI 1 | \$ 469 | Y | Y | Y | Y | Y |
| CFT-48-GM-C | Clean face trim - Gun Metal | HTI 1 | \$ 509 | 14 | 14 | 14 | 14 | Y |
| CFT-48-NB-C | Clean Face Trim - New Bronze | HTI 1 | \$ 509 | 14 | 14 | 14 | 14 | Y |
| CFT-48-SS-C | Clean face trim - Stainless Steel | HTI 1 | \$ 849 | 14 | 14 | 14 | 14 | Y |

Loft Forge 48

| | | | | | | | | |
|--------------|--|-------|----------|----|----|----|----|---|
| LOFTFORGE-48 | Loft Forge hand-crafted front. Max finishing material depth = 1" | HNG 1 | \$ 1,509 | 14 | 14 | 14 | 14 | N |
|--------------|--|-------|----------|----|----|----|----|---|

Quattro 48

| | | | | | | | | |
|----------|----------------------------|-------|--------|----|----|----|----|---|
| QT-48-BK | Quattro front - Black | HNG 1 | \$ 809 | 14 | 14 | 14 | 14 | N |
| QT-48-NB | Quattro front - New Bronze | HNG 1 | \$ 849 | 14 | 14 | 14 | 14 | N |



Clean Face Trim



Loft Forge 48



Quattro 48

Media (Required to Complete)

Crushed Glass Media

| | | | | | | | | |
|-----------------|--|-------|--------|----|----|----|----|---|
| MEDIA-CLEAR-48 | Glass media, crystal (translucent white) | HTI 1 | \$ 259 | Y | Y | Y | Y | Y |
| MEDIA-RED-48 | Glass media, scarlet (red) | HTI 1 | \$ 369 | 14 | 21 | 14 | 14 | Y |
| MEDIA-FOG-48 | Iced fog media (requires black spray paint finish) | HNG 1 | \$ 369 | Y | Y | Y | 14 | Y |
| MEDIA-EBONY-48 | Glass media, ebony (black) | HTI 1 | \$ 369 | Y | Y | Y | Y | Y |
| MEDIA-COBALT-48 | Glass media, cobalt (blue) | HTI 1 | \$ 369 | Y | 21 | Y | 14 | Y |
| MEDIA-AMBER-48 | Glass media, amber | HTI 1 | \$ 369 | Y | Y | Y | Y | Y |

| | | | | | | | | | | |
|--|--|-------|----|-------|----|----|----|----|---|---|
| MEDIA | | | | | | | | | | |
| STONES-48 | River Rock Stone Set (requires media) | HNG 1 | \$ | 169 | Y | 14 | Y | 14 | Y | Y |
| Conversion Kit | | | | | | | | | | |
| Conversion Kit | | | | | | | | | | |
| NGK-MC-C | NG Conversion Kit | HTI 1 | \$ | 99 | 14 | 14 | 14 | 14 | Y | Y |
| LPK-6048 | LP conversion kit | HTI 1 | \$ | 99 | Y | Y | Y | Y | Y | Y |
| Gas Logs - Log Set Option | | | | | | | | | | |
| Driftwood Log Set | | | | | | | | | | |
| DRIFTLOGS-48 | Driftwood Log Set (requires media) | HNG 1 | \$ | 539 | Y | Y | Y | 14 | Y | Y |
| Natural Log Set | | | | | | | | | | |
| LOGS-48 | Natural Log Set (requires media) | HTI 1 | \$ | 399 | Y | Y | Y | 14 | Y | Y |
| Options & Accessories | | | | | | | | | | |
| Options & Accessories | | | | | | | | | | |
| ST48-CFP | Light baffle kit. Recommended for use when two CFT fronts are being installed. | HTI 1 | \$ | 99 | 14 | 21 | 14 | 14 | Y | Y |
| Heat Management | | | | | | | | | | |
| Heat Management | | | | | | | | | | |
| PH-SIDETRIM | Passive Heat trim kit for side discharge (includes 2 side registers)(Starting collars sold separately) | HTI 1 | \$ | 110 | Y | Y | Y | Y | Y | Y |
| PH-MCE | Starting Collars for Non-Ducted Passive Heat (Required when using passive heat - For use with Front, Side, Top Discharges) | HTI 1 | \$ | 179 | Y | Y | Y | Y | Y | Y |
| PH-FRTRIM-48 | Passive Heat Vent Trim Kit For Front Discharge (48")(Starting collars sold separately) | HTI 1 | \$ | 219 | Y | Y | Y | Y | Y | Y |
| Heat Management - Ducted | | | | | | | | | | |
| PHTRIM-MCE-48 | Ducted vent trim for front discharge using ducted Passive Heat (PHFR-MCE-48) | HTI 1 | \$ | 269 | 14 | 14 | 14 | Y | Y | Y |
| PHSI-MCE | Ducted Passive Heat kit for side discharge (includes duct and 2 side registers) | HTI 1 | \$ | 569 | 14 | 21 | 14 | 14 | Y | Y |
| PHFR-MCE-48 | Ducted Passive Heat kit for front discharge (requires PHTRIM-MCE-48 front trim) | HTI 1 | \$ | 689 | 14 | 14 | Y | Y | Y | Y |
| Heat Out Kit | | | | | | | | | | |
| HEAT-OUT-GAS | Heat out kit (includes termination cap, 25' of 6" round duct, fireplace adapter, damper, wall switch and 350CFM fan at termination) | HTI 1 | \$ | 1,529 | Y | 14 | Y | 14 | Y | Y |
| Heat Zone Kit | | | | | | | | | | |
| HZLIN-ADP | Heat Zone adaptor, must order for using HEAT-ZONE-GAS | HTI 1 | \$ | 179 | Y | Y | Y | 14 | Y | Y |
| HEAT-ZONE-GAS | Heat-Zone Kit includes fan, 20' of 6" round duct, vent, wall adapter & on/off control. Wire Plug Assembly 26D0619 required if controlling w/RC400 remote. Used in IFT units with ACM & not a GFK fan. Compatible for up to 2 HEAT-ZONE-GAS kits. See manual. | HTI 1 | \$ | 569 | Y | Y | Y | Y | Y | Y |
| Control, remotes, wall switches | | | | | | | | | | |
| Battery Back Up | | | | | | | | | | |
| BATTERY-WSK | Battery backup wall switch kit for units with IFT control systems. Includes: On/Off Wall Switch, USB-C Port, Battery Backup, Cover Plate, 12' Wire Harness | HTI 1 | \$ | 189 | Y | 14 | Y | 14 | Y | Y |

| IntelliFire app | | | | | | | | |
|---------------------|---|-------|--------|---|---|---|---|---|
| IFT-WFM | IntelliFire Wi-Fi Module that works with the IntelliFire iOS and Android app. Use to control all the features of your fireplace via a smart device. An RC400, RC450 or RC150 is required for thermostat control | HTI 1 | \$ 229 | Y | Y | Y | Y | Y |
| Touch Screen Remote | | | | | | | | |
| IFT-RC400 | IntelliFire Touch black remote control, docking station and auxiliary control module (on/off, flame height, thermostat mode, fan control, child lock, cold climate, timer mode, hot indicator, lights, on-screen maintenance and troubleshooting notifications) | HTI 1 | \$ 389 | Y | Y | Y | Y | Y |
| Wall Switch | | | | | | | | |
| IFT-RC150-HNG | IntelliFire Touch white wireless wall switch (on/off, cold climate, battery strength indicator) | HNG 1 | \$ 121 | Y | Y | Y | Y | Y |



Battery Back Up



IntelliFire app

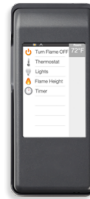

Touch Screen Remote



Wall Switch

Venting

Brick Extension Kit

| | | | | | | | | |
|--------------|--|-------|-------|---|----|----|----|---|
| HEAT-OUT-BEK | Exterior Heat-Zone brick extension kit | HTI 1 | \$ 73 | 8 | 21 | 21 | 14 | Y |
|--------------|--|-------|-------|---|----|----|----|---|

Venting Notes

Requires 8" DVP pipe. Must have 18" minimum vertical before attaching a 90 degree elbow to the unit. See venting section of manual.

Approved for use with PVL-PSLP, PVI-SLP-B and PVV-SLP with power vent wire harness (order separately) and IFT-RC400 remote. See venting section of manual.

MEZZO 60 See-Through

Includes:

- 26,500 - 50,000 Btu/Hour Input(NG)
- 22,000 - 41,000 Btu/Hour Input (LP)
- Clear LED dimmable lights
- Black glass refractory
- RC400 Remote Control
- Ceramic Glass
- Junction box
- Gas flex connector
- Battery backup
- IntelliFire Touch ignition system



Special Considerations:

- If installing driftwood log set & river rock stones, only 1 stone set can be used
- If installing only river rock stones, 2 sets can be used

Required to Complete - Sold Separately: • 2 Fronts • Crushed Glass Media

| | | Disc. Code | MSRP USD | 004 IA | 010 PA | 014 CA | 016 NC | EXP |
|-------------|---|------------|----------|--------|--------|--------|--------|-----|
| MEZZO60ST-C | MEZZO 60ST top direct vent fireplace with IntelliFire Touch Ignition (NG) | HNG 1 | \$ 9,989 | 14 | 14 | 14 | 14 | N |

Fronts - Non-Operable (Required to Complete)

Clean Face Trim

| | | | | | | | | |
|-------------|-----------------------------------|-------|----------|----|----|----|----|---|
| CFT-60-BK-C | Clean face trim - Black | HTI 1 | \$ 789 | Y | Y | Y | Y | Y |
| CFT-60-GM-C | Clean face trim - Gun Metal | HTI 1 | \$ 829 | 14 | 14 | 14 | 14 | Y |
| CFT-60-NB-C | Clean Face Trim - New Bronze | HTI 1 | \$ 829 | 14 | 14 | 14 | 14 | Y |
| CFT-60-SS-C | Clean face trim - Stainless Steel | HTI 1 | \$ 1,099 | 14 | 14 | 14 | 14 | Y |

Loft Forge 60

| | | | | | | | | |
|--------------|--|-------|----------|----|----|----|----|---|
| LOFTFORGE-60 | Loft Forge hand-crafted front. Max finishing material depth = 1" | HNG 1 | \$ 1,829 | 14 | 14 | 14 | 14 | N |
|--------------|--|-------|----------|----|----|----|----|---|

Quattro 60

| | | | | | | | | |
|----------|----------------------------|-------|----------|----|----|----|----|---|
| QT-60-BK | Quattro front - Black | HNG 1 | \$ 1,149 | 14 | 14 | 14 | 14 | N |
| QT-60-NB | Quattro front - New Bronze | HNG 1 | \$ 1,199 | 14 | 14 | 21 | 14 | N |



Clean Face Trim



Loft Forge 60



Quattro 60

Media (Required to Complete)

Crushed Glass Media

| | | | | | | | | |
|-----------------|--|-------|--------|----|----|----|----|---|
| MEDIA-CLEAR-60 | Glass media, crystal (translucent white) | HTI 1 | \$ 369 | Y | Y | Y | Y | Y |
| MEDIA-EBONY-60 | Glass media, ebony (black) | HTI 1 | \$ 479 | Y | Y | Y | Y | Y |
| MEDIA-FOG-60 | Iced fog media (requires black spray paint finish) | HNG 1 | \$ 479 | Y | Y | Y | 14 | Y |
| MEDIA-RED-60 | Glass media, scarlet (red) | HTI 1 | \$ 479 | 14 | 21 | 14 | 14 | Y |
| MEDIA-AMBER-60 | Glass media, amber | HTI 1 | \$ 479 | Y | 21 | Y | 14 | Y |
| MEDIA-COBALT-60 | Glass media, cobalt (blue) | HTI 1 | \$ 479 | 14 | 21 | 14 | 14 | Y |

| MEDIA | | | | | | | | | | |
|---------------------------------|--|-------|----|-------|----|----|----|----|----|---|
| STONES-60 | River Rock Stone Set (requires media) | HNG 1 | \$ | 209 | Y | 14 | 14 | 14 | 14 | Y |
| Conversion Kit | | | | | | | | | | |
| Conversion Kit | | | | | | | | | | |
| LPK-7260 | LP conversion kit | HTI 1 | \$ | 99 | Y | Y | Y | Y | Y | Y |
| NGK-MC-C | NG Conversion Kit | HTI 1 | \$ | 99 | 14 | 14 | 14 | 14 | 14 | Y |
| Gas Logs - Log Set Option | | | | | | | | | | |
| Driftwood Log Set | | | | | | | | | | |
| DRIFTLOGS-60 | Driftwood Log Set (requires media) | HNG 1 | \$ | 659 | Y | 14 | Y | 14 | Y | Y |
| Natural Log Set | | | | | | | | | | |
| LOGS-60 | Natural Log Set (requires media) | HTI 1 | \$ | 529 | Y | 14 | 14 | 14 | 14 | Y |
| Options & Accessories | | | | | | | | | | |
| Options & Accessories | | | | | | | | | | |
| ST60-CFP | Light baffle kit. Recommended for use when two CFT fronts are being installed. | HTI 1 | \$ | 111 | 14 | 21 | 14 | 14 | 14 | Y |
| Heat Management | | | | | | | | | | |
| Heat Management | | | | | | | | | | |
| PH-SIDETRIM | Passive Heat trim kit for side discharge (includes 2 side registers)(Starting collars sold separately) | HTI 1 | \$ | 110 | Y | Y | Y | Y | Y | Y |
| PH-MCE | Starting Collars for Non-Ducted Passive Heat (Required when using passive heat - For use with Front, Side, Top Discharges) | HTI 1 | \$ | 179 | Y | Y | Y | Y | Y | Y |
| PH-FRTRIM-60 | Passive Heat Vent Trim Kit For Front Discharge (60")(Starting collars sold separately) | HTI 1 | \$ | 229 | Y | Y | Y | 14 | Y | Y |
| Heat Management - Ducted | | | | | | | | | | |
| PHTRIM-MCE-60 | Ducted vent trim for front discharge using ducted Passive Heat (PHFR-MCE-60) | HTI 1 | \$ | 279 | Y | Y | 14 | 14 | N | Y |
| PHFR-MCE-60 | Ducted Passive Heat kit for front discharge (requires PHTRIM-MCE-60 front trim) | HTI 1 | \$ | 759 | Y | Y | Y | 14 | Y | Y |
| Heat Out Kit | | | | | | | | | | |
| HEAT-OUT-GAS | Heat out kit (includes termination cap, 25' of 6" round duct, fireplace adapter, damper, wall switch and 350CFM fan at termination) | HTI 1 | \$ | 1,529 | Y | 14 | Y | 14 | Y | Y |
| Heat Zone Kit | | | | | | | | | | |
| HZLIN-ADP | Heat Zone adaptor, must order for using HEAT-ZONE-GAS | HTI 1 | \$ | 179 | Y | Y | Y | 14 | Y | Y |
| HEAT-ZONE-GAS | Heat-Zone Kit includes fan, 20' of 6" round duct, vent, wall adapter & on/off control. Wire Plug Assembly 26D0619 required if controlling w/RC400 remote. Used in IFT units with ACM & not a GFK fan. Compatible for up to 2 HEAT-ZONE-GAS kits. See manual. | HTI 1 | \$ | 569 | Y | Y | Y | Y | Y | Y |
| Control, remotes, wall switches | | | | | | | | | | |
| Battery Back Up | | | | | | | | | | |
| BATTERY-WSK | Battery backup wall switch kit for units with IFT control systems. Includes: On/Off Wall Switch, USB-C Port, Battery Backup, Cover Plate, 12' Wire Harness | HTI 1 | \$ | 189 | Y | 14 | Y | 14 | Y | Y |
| IntelliFire app | | | | | | | | | | |
| IFT-WFM | IntelliFire Wi-Fi Module that works with the IntelliFire iOS and Android app. Use to control all the features of your fireplace via a smart device. An RC400, RC450 or RC150 is required for thermostat control | HTI 1 | \$ | 229 | Y | Y | Y | Y | Y | Y |

Touch Screen Remote

| | | | | | | | | |
|-----------|---|-------|--------|---|---|---|---|---|
| IFT-RC400 | IntelliFire Touch black remote control, docking station and auxiliary control module (on/off, flame height, thermostat mode, fan control, child lock, cold climate, timer mode, hot indicator, lights, on-screen maintenance and troubleshooting notifications) | HTI 1 | \$ 389 | Y | Y | Y | Y | Y |
|-----------|---|-------|--------|---|---|---|---|---|

Wall Switch

| | | | | | | | | |
|---------------|---|-------|--------|---|---|---|---|---|
| IFT-RC150-HNG | IntelliFire Touch white wireless wall switch (on/off, cold climate, battery strength indicator) | HNG 1 | \$ 121 | Y | Y | Y | Y | Y |
|---------------|---|-------|--------|---|---|---|---|---|



Battery Back Up



IntelliFire app

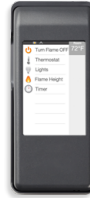

Touch Screen Remote



Wall Switch

Venting

Brick Extension Kit

| | | | | | | | | |
|--------------|--|-------|-------|---|----|----|----|---|
| HEAT-OUT-BEK | Exterior Heat-Zone brick extension kit | HTI 1 | \$ 73 | 8 | 21 | 21 | 14 | Y |
|--------------|--|-------|-------|---|----|----|----|---|

Venting Notes

Requires 8" DVP pipe. Must have 18" minimum vertical before attaching a 90 degree elbow to the unit. See venting section of manual.

Approved for use with PVL-PSLP, PVI-SLP-B and PVV-SLP with power vent wire harness (order separately) and IFT-RC400 remote. See venting section of manual.

MEZZO 72 See-Through

Includes:

- 30,500 - 58,000 Btu/Hour Input(NG)
- 24,000 - 46,000 Btu/Hour Input (LP)
- Clear LED dimmable lights
- Black glass refractory
- RC400 Remote Control
- Ceramic Glass
- Junction box
- Gas flex connector
- Battery backup
- IntelliFire Touch ignition system



Special Considerations:

- If installing driftwood log set & river rock stones, only 1 stone set can be used
- If installing only river rock stones, 2 sets can be used

Required to Complete - Sold Separately: • 2 Fronts • Crushed Glass Media

| | | Disc. Code | MSRP USD | 004 IA | 010 PA | 014 CA | 016 NC | EXP |
|-------------|---|---------------|-------------|-----------|-----------|-----------|-----------|-----|
| MEZZO72ST-C | MEZZO 72ST top direct vent fireplace with IntelliFire Touch Ignition (NG) | HNG 1 | \$ 12,669 | 14 | 14 | 14 | 14 | N |

Fronts - Non-Operable (Required to Complete)

Clean Face Trim

| | | | | | | | | |
|-------------|-----------------------------------|-------|----------|----|----|----|----|---|
| CFT-72-BK-C | Clean face trim - Black | HTI 1 | \$ 839 | Y | Y | Y | Y | Y |
| CFT-72-GM-C | Clean face trim - Gun Metal | HTI 1 | \$ 899 | 14 | 14 | 14 | 14 | Y |
| CFT-72-NB-C | Clean Face Trim - New Bronze | HTI 1 | \$ 899 | 14 | 14 | 14 | 14 | Y |
| CFT-72-SS-C | Clean face trim - Stainless Steel | HTI 1 | \$ 1,229 | 14 | 14 | 14 | 14 | Y |



Clean Face Trim

Media (Required to Complete)

Crushed Glass Media

| | | | | | | | | |
|-----------------|--|-------|--------|----|----|----|----|---|
| MEDIA-CLEAR-72 | Glass media, crystal (translucent white) | HTI 1 | \$ 479 | Y | Y | Y | 14 | Y |
| MEDIA-AMBER-72 | Glass media, amber | HTI 1 | \$ 589 | 14 | 21 | 14 | 14 | Y |
| MEDIA-COBALT-72 | Glass media, cobalt (blue) | HTI 1 | \$ 589 | 14 | 21 | 14 | 14 | Y |
| MEDIA-EBONY-72 | Glass media, ebony (black) | HTI 1 | \$ 589 | Y | 21 | Y | 14 | Y |
| MEDIA-FOG-72 | Iced fog media (requires black spray paint finish) | HNG 1 | \$ 589 | Y | 21 | 14 | 14 | Y |
| MEDIA-RED-72 | Glass media, scarlet (red) | HTI 1 | \$ 589 | 14 | 21 | 14 | 14 | Y |

MEDIA

| | | | | | | | | |
|-----------|---------------------------------------|-------|--------|----|----|----|----|---|
| STONES-72 | River Rock Stone Set (requires media) | HNG 1 | \$ 239 | 21 | 14 | 14 | 14 | Y |
|-----------|---------------------------------------|-------|--------|----|----|----|----|---|

Conversion Kit

Conversion Kit

| | | | | | | | | |
|----------|-------------------|-------|-------|----|----|----|----|---|
| NGK-MC-C | NG Conversion Kit | HTI 1 | \$ 99 | 14 | 14 | 14 | 14 | Y |
| LPK-8472 | LP conversion kit | HTI 1 | \$ 99 | Y | 21 | Y | 14 | Y |

| Gas Logs - Log Set Option | | | | | | | | | | |
|---------------------------------|---|-------|----------|--|----|----|----|----|---|--|
| Driftwood Log Set | | | | | | | | | | |
| DRIFTLOGS-72 | Driftwood Log Set (requires media) | HNG 1 | \$ 779 | | 14 | 14 | 14 | 14 | Y | |
| Natural Log Set | | | | | | | | | | |
| LOGS-72 | Natural Log Set (requires media) | HTI 1 | \$ 659 | | 14 | 14 | 14 | 14 | Y | |
| Options & Accessories | | | | | | | | | | |
| Options & Accessories | | | | | | | | | | |
| ST72-CFP | Light baffle kit. Recommended for use when two CFT fronts are being installed. | HTI 1 | \$ 111 | | 14 | 21 | 14 | 14 | Y | |
| Heat Management | | | | | | | | | | |
| Heat Management | | | | | | | | | | |
| PH-SIDETRIM | Passive Heat trim kit for side discharge (includes 2 side registers)(Starting collars sold separately) | HTI 1 | \$ 110 | | Y | Y | Y | Y | Y | |
| PH-MCE | Starting Collars for Non-Ducted Passive Heat (Required when using passive heat - For use with Front, Side, Top Discharges) | HTI 1 | \$ 179 | | Y | Y | Y | Y | Y | |
| PH-FRTRIM-72 | Passive Heat Vent Trim Kit For Front Discharge (72")(Starting collars sold separately) | HTI 1 | \$ 239 | | Y | 14 | Y | 14 | Y | |
| Heat Management - Ducted | | | | | | | | | | |
| PHTRIM-MCE-72 | Ducted vent trim for front discharge using ducted Passive Heat (PHFR-MCE-72) | HTI 1 | \$ 289 | | 14 | 14 | 14 | 14 | Y | |
| PHFR-MCE-72 | Ducted Passive Heat kit for front discharge (requires PHTRIM-MCE-72 front trim) | HTI 1 | \$ 809 | | 14 | 14 | 14 | 14 | Y | |
| Heat Out Kit | | | | | | | | | | |
| HEAT-OUT-GAS | Heat out kit (includes termination cap, 25' of 6" round duct, fireplace adapter, damper, wall switch and 350CFM fan at termination) | HTI 1 | \$ 1,529 | | Y | 14 | Y | 14 | Y | |
| Heat Zone Kit | | | | | | | | | | |
| HZLIN-ADP | Heat Zone adaptor, must order for using HEAT-ZONE-GAS | HTI 1 | \$ 179 | | Y | Y | Y | 14 | Y | |
| HEAT-ZONE-GAS | Heat-Zone Kit includes fan, 20' of 6" round duct, vent, wall adapter & on/off control. Wire Plug Assembly 26D0619 required if controlling w/RC400 remote. Used in IFT units with ACM & not a GFK fan. Compatible for up to 2 HEAT-ZONE-GAS kits. See manual. | HTI 1 | \$ 569 | | Y | Y | Y | Y | Y | |
| Control, remotes, wall switches | | | | | | | | | | |
| Battery Back Up | | | | | | | | | | |
| BATTERY-WSK | Battery backup wall switch kit for units with IFT control systems. Includes: On/Off Wall Switch, USB-C Port, Battery Backup, Cover Plate, 12' Wire Harness | HTI 1 | \$ 189 | | Y | 14 | Y | 14 | Y | |
| IntelliFire app | | | | | | | | | | |
| IFT-WFM | IntelliFire Wi-Fi Module that works with the IntelliFire iOS and Android app. Use to control all the features of your fireplace via a smart device. An RC400, RC450 or RC150 is required for thermostat control | HTI 1 | \$ 229 | | Y | Y | Y | Y | Y | |
| Touch Screen Remote | | | | | | | | | | |
| IFT-RC400 | IntelliFire Touch black remote control, docking station and auxiliary control module (on/off, flame height, thermostat mode, fan control, child lock, cold climate, timer mode, hot indicator, lights, on-screen maintenance and troubleshooting notifications) | HTI 1 | \$ 389 | | Y | Y | Y | Y | Y | |

Wall Switch

| | | | | | | | | | |
|---------------|---|-------|----|-----|---|---|---|---|---|
| IFT-RC150-HNG | IntelliFire Touch white wireless wall switch (on/off, cold climate, battery strength indicator) | HNG 1 | \$ | 121 | Y | Y | Y | Y | Y |
|---------------|---|-------|----|-----|---|---|---|---|---|



Battery Back Up



IntelliFire app

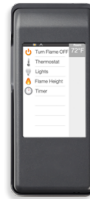

Touch Screen Remote



Wall Switch

Venting

Brick Extension Kit

| | | | | | | | | | |
|--------------|--|-------|----|----|---|----|----|----|---|
| HEAT-OUT-BEK | Exterior Heat-Zone brick extension kit | HTI 1 | \$ | 73 | 8 | 21 | 21 | 14 | Y |
|--------------|--|-------|----|----|---|----|----|----|---|

Venting Notes

Requires 8" DVP pipe. Must have 30" minimum vertical before attaching a 90 degree elbow to the unit. See venting section of manual.

Approved for use with PVL-PSLP, PVI-SLP-B and PVV-SLP with power vent wire harness (order separately) and IFT-RC400 remote. See venting section of manual.

Primo II 48ST

Includes:

- 45,000 - 31,500 BTU/Hour Input (NG)
- 45,000 - 31,500 BTU/Hour Input (LP)
- 48" W x 18" H Glass Viewing Size
- Intellifire Touch 2.0 Ignition System
- RC-450 Remote Control
- Multi-Colored LED Lights
- 6" Outside Air Starting Collar & Exterior Hood (6" Insulated Flex Sold Separately)
- Suction Cups Recommended (Not Included) to Install and Remove Safe Surface & Firebox Glass
- Advanced Technology Product Training Required Before Product Ships



Special Considerations:

- Crushed Glass Media Only (Not Included): 4 Bags
- Crushed Glass Media With Logs (Not Included): 3 Bags
- Stones (Not Included): use only 1 set, requires media, cannot be used with logs
- When Terminating Horizontal The HZTERM-ADP Kit Is Required Along With a Standard Trap Cap

Required to Complete - Sold Separately:

- Safe Surface Glass (QTY 2)
- Liner Kit
- Crushed Glass Media
- 6" Insulated Flex Duct

| | | | Disc. Code | MSRP USD | 004 IA | 010 PA | 014 CA | 016 NC | EXP |
|---------------|--|-------|------------|----------|--------|--------|--------|--------|-----|
| PRIMO-II-48ST | 48" See Through Direct Vent Gas Fireplace Top Vent With IntelliFire Touch 2.0 Ignition System (NG) | HNG 1 | | \$ 9,799 | 14 | 14 | 14 | 14 | N |

Fronts - Non-Operable (Required to Complete)

Safe Surface Glass

| | | | | | | | | | |
|-------------|-------------------------------|-------|--|--------|---|----|---|----|---|
| GLASS-SS-48 | 48" SafeSurface Barrier Glass | HNG 1 | | \$ 419 | Y | 14 | Y | 14 | Y |
|-------------|-------------------------------|-------|--|--------|---|----|---|----|---|



Safe Surface Glass

Media (Required to Complete)

Crushed Glass Media

| | | | | | | | | | |
|----------|---|-------|--|-------|---|---|---|---|---|
| MEDIA-CP | Copper Embers - Crushed Glass Media (1 bag, 5lbs) | HTI 1 | | \$ 77 | Y | Y | Y | Y | Y |
| MEDIA-CY | Crystal Embers - Crushed Glass Media (1 bag, 5lbs) | HTI 1 | | \$ 77 | Y | Y | Y | Y | Y |
| MEDIA-GT | Graphite Embers - Crushed Glass Media (1 bag, 5lbs) | HTI 1 | | \$ 77 | Y | Y | Y | Y | Y |
| MEDIA-SM | Smoked Embers - Crushed Glass Media (1 bag, 5lbs) | HTI 1 | | \$ 77 | Y | Y | Y | Y | Y |

MEDIA

| | | | | | | | | | |
|-----------|---------------------------------------|-------|--|--------|---|----|---|----|---|
| STONES-48 | River Rock Stone Set (requires media) | HNG 1 | | \$ 169 | Y | 14 | Y | 14 | Y |
|-----------|---------------------------------------|-------|--|--------|---|----|---|----|---|

| Liner Kit (Required to Complete) | | | | | | | | | | |
|---|---|-------|----|-----|----|----|----|----|----|---|
| Architectural Fiber Refractory | | | | | | | | | | |
| ACT-PR-ST | See Through Architectural Fiber Refractory | HNG 1 | \$ | 349 | Y | 14 | 14 | 14 | 14 | Y |
| Black Glass Liner - Fluted | | | | | | | | | | |
| BGK-FL-PR-ST | See Through Black Glass Liner - Fluted | HNG 1 | \$ | 459 | Y | 14 | 14 | 14 | 14 | Y |
| Black Glass Liner - Marbled | | | | | | | | | | |
| BGK-MAR-PR-ST | See Through Black Glass Liner - Marbled | HNG 1 | \$ | 459 | Y | 14 | 14 | 14 | 14 | Y |
| Black Glass Liner - Reflective | | | | | | | | | | |
| BGK-PR-ST | See Through Black Glass Liner - Reflective | HNG 1 | \$ | 459 | Y | 14 | 14 | 14 | 14 | Y |
| Column Fiber Refractory | | | | | | | | | | |
| COL-PR-ST | See Through Stone Column Fiber Refractory | HNG 1 | \$ | 349 | Y | 14 | 14 | 14 | 14 | Y |
| Venting (Required to Complete) | | | | | | | | | | |
| Insulated Flex Duct - Chimney Air Kits/Flex Duct | | | | | | | | | | |
| ID6 | 6" (152mm) insulated flex duct for use with outside air kit - includes two 42" (1065mm) sections | HTI 1 | \$ | 100 | Y | Y | Y | Y | Y | Y |
| 6" Insulated Flex Duct | | | | | | | | | | |
| FLEXDUCT6AI | 6" (152mm) insulated flex duct for outside air - 25' | HTI 1 | \$ | 100 | Y | Y | Y | Y | Y | Y |
| LP Conversion Kit | | | | | | | | | | |
| LP Conversion Kit | | | | | | | | | | |
| LPK-PRIMOII | LP Conversion Kit for Primo II Series | HNG 1 | \$ | 99 | Y | Y | Y | Y | Y | Y |
| Gas Logs - Log Set Option | | | | | | | | | | |
| Birch Logs | | | | | | | | | | |
| BIRLG-LIN-SM | 48" Birch Log Set (Requires Crushed Glass Media) | HNG 1 | \$ | 549 | Y | 14 | 14 | 14 | 14 | Y |
| Driftwood Logs | | | | | | | | | | |
| DWLG-LIN-SM | 48" Driftwood Log Set (Requires Crushed Glass Media) | HTI 1 | \$ | 549 | | 28 | 28 | 28 | 28 | Y |
| Traditional Logs | | | | | | | | | | |
| OAKLG-LIN-SM | 48" Traditional Log Set (Requires Crushed Glass Media) | HTI 1 | \$ | 549 | 21 | 14 | 14 | 14 | 14 | Y |
| Options & Accessories | | | | | | | | | | |
| Carry Handle | | | | | | | | | | |
| CARRY-HANDLE | Reusable Carry Handle for use with PRIMO-II (1 pcs, need 2 per unit) | HTI 1 | \$ | 179 | 14 | 14 | 14 | 14 | 14 | Y |
| Heat Management | | | | | | | | | | |
| Primo Heat Duct | | | | | | | | | | |
| PRIMO-HEAT-DUCT | Heat Zone Duct Kit - Includes Unit Collar, 10" x 4" x 6" 90 Degree Register Duct Boot, 10" x 4" White Sidewall and Ceiling Register, 25' of 6" Insulated Flex Duct | HNG 1 | \$ | 169 | Y | 14 | Y | 14 | Y | Y |
| Control, remotes, wall switches | | | | | | | | | | |
| IntelliFire app | | | | | | | | | | |
| IFT-WFM | IntelliFire Wi-Fi Module that works with the IntelliFire iOS and Android app. Use to control all the features of your fireplace via a smart device. An RC400, RC450 or RC150 is required for thermostat control | HTI 1 | \$ | 229 | Y | Y | Y | Y | Y | Y |

| IntelliFire Touch Controls - Aux Module | | | | | | | | | |
|---|--|-------|-----|-----|----|----|----|----|---|
| IFT2-PACM | IntelliFire Touch 2.0 Premium AUX Module. Controls Lights, Fans, Power Vents, HTI 1 or Heat Management. Does not include RC450 Touchscreen remote | \$ | 144 | 14 | 14 | 14 | 14 | Y | |
| Touch Screen Remote | | | | | | | | | |
| IFT2-RC450 | IntelliFire Touch 2.0 touchscreen remote and docking station. Controls flame On/Off, Lights, Fans, Heat Management, Timer, Thermostat, Flame Height, On-screen maintenance and troubleshooting notifications (IFT2-PACM sold separately) | HTI 1 | \$ | 259 | 14 | 14 | 14 | 14 | Y |
| Wall Switch | | | | | | | | | |
| IFT-RC150U | Universally compatible with IntelliFire Touch and IntelliFire Touch 2.0 systems. White wireless wall switch for On/Off and Cold Climate control | HTI 1 | \$ | 121 | 14 | 14 | 14 | 14 | Y |



IntelliFire app

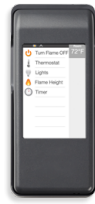

Touch Screen Remote



Wall Switch

Termination Kits

Horizontal Termination Kit

| | | | | | | | | | |
|------------|---|-------|----|-----|---|---|---|---|---|
| HZTERM-ADP | Horizontal Termination Adaptor Kit - Includes Base and Face Trim (Required For All Horizontal Terminations, To Be Used With Standard DVP and SLP Trap Caps) | HNG 1 | \$ | 169 | Y | Y | Y | Y | Y |
|------------|---|-------|----|-----|---|---|---|---|---|

Miscellaneous ACC

Indoor/Outdoor Kit

| | | | | | | | | | |
|-----------|---|-------|----|-----|----|----|----|----|---|
| ODK-PR-48 | 48" Indoor/Outdoor Kit (for use with PRIMO-II-48ST, 1 kit required only when installing as an indoor/outdoor unit) (Kit does not include a window, window provided by others) | HNG 1 | \$ | 419 | 14 | 14 | 14 | 14 | Y |
|-----------|---|-------|----|-----|----|----|----|----|---|

Venting Notes

| |
|---|
| DVP and SLP Venting Approved (DVP Starting Collar) |
| See Venting Section In Install Manual For Approved Pipe and Termination Caps |
| 6" Insulated Flex Duct For Outside Air |
| When Terminating Horizontal the HZTERM-ADP Kit Is Required Along With a Standard Trap Cap |

Primo II 60ST

Includes:

- 55,000 - 38,500 BTU/Hour Input (NG)
- 55,000 - 38,500 BTU/Hour Input (LP)
- 60" W x 18" H Glass Viewing Size
- Intellifire Touch 2.0 Ignition System
- RC-450 Remote Control
- Multi-Colored LED Lights
- 6" Outside Air Starting Collar & Exterior Hood (6" Insulated Flex Sold Separately)
- Suction Cups Recommended (Not Included) to Install and Remove Safe Surface & Firebox Glass
- Advanced Technology Product Training Required Before Product Ships



Special Considerations:

- Crushed Glass Media Only (Not Included): 5 Bags
- Crushed Glass Media With Logs (Not Included): 4 Bags
- Stones (Not Included): use only 1 set, requires media, cannot be used with logs
- When Terminating Horizontal The HZTERM-ADP Kit Is Required Along With a Standard Trap Cap

Required to Complete - Sold Separately: • Safe Surface Glass (QTY 2) • Liner Kit
 • Crushed Glass Media • 6" Insulated Flex Duct

| | | Disc. Code | MSRP USD | 004 IA | 010 PA | 014 CA | 016 NC | EXP |
|---------------|--|------------|-----------|--------|--------|--------|--------|-----|
| PRIMO-II-60ST | 60" See Through Direct Vent Gas Fireplace Top Vent With IntelliFire Touch 2.0 Ignition System (NG) | HNG 1 | \$ 12,279 | 14 | 14 | 14 | 14 | N |

Fronts - Non-Operable (Required to Complete)

Safe Surface Glass

| | | | | | | | | |
|-------------|-------------------------------|-------|--------|---|---|---|---|---|
| GLASS-SS-60 | 60" SafeSurface Barrier Glass | HNG 1 | \$ 469 | Y | Y | Y | Y | Y |
|-------------|-------------------------------|-------|--------|---|---|---|---|---|



Safe Surface Glass

Media (Required to Complete)

Crushed Glass Media

| | | | | | | | | |
|----------|---|-------|-------|---|---|---|---|---|
| MEDIA-CP | Copper Embers - Crushed Glass Media (1 bag, 5lbs) | HTI 1 | \$ 77 | Y | Y | Y | Y | Y |
| MEDIA-CY | Crystal Embers - Crushed Glass Media (1 bag, 5lbs) | HTI 1 | \$ 77 | Y | Y | Y | Y | Y |
| MEDIA-GT | Graphite Embers - Crushed Glass Media (1 bag, 5lbs) | HTI 1 | \$ 77 | Y | Y | Y | Y | Y |
| MEDIA-SM | Smoked Embers - Crushed Glass Media (1 bag, 5lbs) | HTI 1 | \$ 77 | Y | Y | Y | Y | Y |

MEDIA

| | | | | | | | | |
|-----------|---------------------------------------|-------|--------|---|----|----|----|---|
| STONES-60 | River Rock Stone Set (requires media) | HNG 1 | \$ 209 | Y | 14 | 14 | 14 | Y |
|-----------|---------------------------------------|-------|--------|---|----|----|----|---|

| Liner Kit (Required to Complete) | | | | | | | | | | |
|---|---|-------|----|-----|----|----|----|----|----|---|
| Architectural Fiber Refractory | | | | | | | | | | |
| ACT-PR-ST | See Through Architectural Fiber Refractory | HNG 1 | \$ | 349 | Y | 14 | 14 | 14 | 14 | Y |
| Black Glass Liner - Fluted | | | | | | | | | | |
| BGK-FL-PR-ST | See Through Black Glass Liner - Fluted | HNG 1 | \$ | 459 | Y | 14 | 14 | 14 | 14 | Y |
| Black Glass Liner - Marbled | | | | | | | | | | |
| BGK-MAR-PR-ST | See Through Black Glass Liner - Marbled | HNG 1 | \$ | 459 | Y | 14 | 14 | 14 | 14 | Y |
| Black Glass Liner - Reflective | | | | | | | | | | |
| BGK-PR-ST | See Through Black Glass Liner - Reflective | HNG 1 | \$ | 459 | Y | 14 | 14 | 14 | 14 | Y |
| Column Fiber Refractory | | | | | | | | | | |
| COL-PR-ST | See Through Stone Column Fiber Refractory | HNG 1 | \$ | 349 | Y | 14 | 14 | 14 | 14 | Y |
| Venting (Required to Complete) | | | | | | | | | | |
| Insulated Flex Duct - Chimney Air Kits/Flex Duct | | | | | | | | | | |
| ID6 | 6" (152mm) insulated flex duct for use with outside air kit - includes two 42" (1065mm) sections | HTI 1 | \$ | 100 | Y | Y | Y | Y | Y | Y |
| 6" Insulated Flex Duct | | | | | | | | | | |
| FLEXDUCT6AI | 6" (152mm) insulated flex duct for outside air - 25' | HTI 1 | \$ | 100 | Y | Y | Y | Y | Y | Y |
| LP Conversion Kit | | | | | | | | | | |
| LP Conversion Kit | | | | | | | | | | |
| LPK-PRIMOII | LP Conversion Kit for Primo II Series | HNG 1 | \$ | 99 | Y | Y | Y | Y | Y | Y |
| Gas Logs - Log Set Option | | | | | | | | | | |
| Birch Logs | | | | | | | | | | |
| BIRLG-LIN-LG | 60" & 72" Birch Log Set (Requires Crushed Glass Media) | HNG 1 | \$ | 649 | Y | 14 | 14 | 14 | 14 | Y |
| Driftwood Logs | | | | | | | | | | |
| DWLG-LIN-LG | 60" & 72" Driftwood Log Set (Requires Crushed Glass Media) | HTI 1 | \$ | 649 | Y | 14 | 21 | 14 | 14 | Y |
| Traditional Logs | | | | | | | | | | |
| OAKLG-LIN-LG | 60" & 72" Traditional Log Set (Requires Crushed Glass Media) | HTI 1 | \$ | 649 | 21 | 14 | 14 | 14 | 14 | Y |
| Options & Accessories | | | | | | | | | | |
| Carry Handle | | | | | | | | | | |
| CARRY-HANDLE | Reusable Carry Handle for use with PRIMO-II (1 pcs, need 2 per unit) | HTI 1 | \$ | 179 | 14 | 14 | 14 | 14 | 14 | Y |
| Heat Management | | | | | | | | | | |
| Primo Heat Duct | | | | | | | | | | |
| PRIMO-HEAT-DUCT | Heat Zone Duct Kit - Includes Unit Collar, 10" x 4" x 6" 90 Degree Register Duct Boot, 10" x 4" White Sidewall and Ceiling Register, 25' of 6" Insulated Flex Duct | HNG 1 | \$ | 169 | Y | 14 | Y | 14 | Y | Y |
| Control, remotes, wall switches | | | | | | | | | | |
| IntelliFire app | | | | | | | | | | |
| IFT-WFM | IntelliFire Wi-Fi Module that works with the IntelliFire iOS and Android app. Use to control all the features of your fireplace via a smart device. An RC400, RC450 or RC150 is required for thermostat control | HTI 1 | \$ | 229 | Y | Y | Y | Y | Y | Y |

IntelliFire Touch Controls - Aux Module

| | | | | | | | | |
|-----------|---|--------|-------|----|----|----|----|---|
| IFT2-PACM | IntelliFire Touch 2.0 Premium AUX Module. Controls Lights, Fans, Power Vents, HTI 1 or Heat Management. Does not include RC450 Touchscreen remote | \$ 144 | HTI 1 | 14 | 14 | 14 | 14 | Y |
|-----------|---|--------|-------|----|----|----|----|---|

Touch Screen Remote

| | | | | | | | | |
|------------|--|--------|-------|----|----|----|----|---|
| IFT2-RC450 | IntelliFire Touch 2.0 touchscreen remote and docking station. Controls flame On/Off, Lights, Fans, Heat Management, Timer, Thermostat, Flame Height, On-screen maintenance and troubleshooting notifications (IFT2-PACM sold separately) | \$ 259 | HTI 1 | 14 | 14 | 14 | 14 | Y |
|------------|--|--------|-------|----|----|----|----|---|

Wall Switch

| | | | | | | | | |
|------------|---|--------|-------|----|----|----|----|---|
| IFT-RC150U | Universally compatible with IntelliFire Touch and IntelliFire Touch 2.0 systems. White wireless wall switch for On/Off and Cold Climate control | \$ 121 | HTI 1 | 14 | 14 | 14 | 14 | Y |
|------------|---|--------|-------|----|----|----|----|---|



IntelliFire app

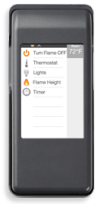

Touch Screen Remote



Wall Switch

Termination Kits

Horizontal Termination Kit

| | | | | | | | | |
|------------|---|--------|-------|---|---|---|---|---|
| HZTERM-ADP | Horizontal Termination Adaptor Kit - Includes Base and Face Trim (Required For All Horizontal Terminations, To Be Used With Standard DVP and SLP Trap Caps) | \$ 169 | HNG 1 | Y | Y | Y | Y | Y |
|------------|---|--------|-------|---|---|---|---|---|

Miscellaneous ACC

Indoor/Outdoor Kit

| | | | | | | | | |
|-----------|---|--------|-------|----|----|----|----|---|
| ODK-PR-60 | 60" Indoor/Outdoor Kit (for use with PRIMO-II-60ST, 1 kit required only when installing as an indoor/outdoor unit) (Kit does not include a window, window provided by others) | \$ 529 | HNG 1 | 14 | 14 | 14 | 14 | Y |
|-----------|---|--------|-------|----|----|----|----|---|

Venting Notes

| |
|---|
| DVP and SLP Venting Approved (DVP Starting Collar) |
| See Venting Section In Install Manual For Approved Pipe and Termination Caps |
| 6" Insulated Flex Duct For Outside Air |
| When Terminating Horizontal the HZTERM-ADP Kit Is Required Along With a Standard Trap Cap |

Primo II 72ST

Includes:

- 59,000 - 38,500 BTU/Hour Input (NG)
- 59,000 - 38,500 BTU/Hour Input (LP)
- 72" W x 18" H Glass Viewing Size
- Intellifire Touch 2.0 Ignition System
- RC-450 Remote Control
- Multi-Colored LED Lights
- 6" Outside Air Starting Collar & Exterior Hood (6" Insulated Flex Sold Separately)
- Suction Cups Recommended (Not Included) to Install and Remove Safe Surface & Firebox Glass
- Advanced Technology Product Training Required Before Product Ships



Special Considerations:

- Crushed Glass Media Only (Not Included): 6 Bags
- Crushed Glass Media With Logs (Not Included): 5 Bags
- Stones (Not Included): use only 1 set, requires media, cannot be used with logs
- When Terminating Horizontal The HZTERM-ADP Kit Is Required Along With a Standard Trap Cap

Required to Complete - Sold Separately:

- Safe Surface Glass (QTY 2)
- Liner Kit
- Crushed Glass Media
- 6" Insulated Flex Duct

| | | Disc. Code | MSRP USD | 004 IA | 010 PA | 014 CA | 016 NC | EXP |
|---------------|--|------------|-----------|--------|--------|--------|--------|-----|
| PRIMO-II-72ST | 72" See Through Direct Vent Gas Fireplace Top Vent With IntelliFire Touch 2.0 Ignition System (NG) | HNG 1 | \$ 15,059 | 14 | 14 | 14 | 14 | N |

Fronts - Non-Operable (Required to Complete)

Safe Surface Glass

| | | | | | | | | |
|-------------|-------------------------------|-------|--------|---|----|---|----|---|
| GLASS-SS-72 | 72" SafeSurface Barrier Glass | HNG 1 | \$ 529 | Y | 14 | Y | 14 | Y |
|-------------|-------------------------------|-------|--------|---|----|---|----|---|



Safe Surface Glass

Media (Required to Complete)

Crushed Glass Media

| | | | | | | | | |
|----------|---|-------|-------|---|---|---|---|---|
| MEDIA-CP | Copper Embers - Crushed Glass Media (1 bag, 5lbs) | HTI 1 | \$ 77 | Y | Y | Y | Y | Y |
| MEDIA-CY | Crystal Embers - Crushed Glass Media (1 bag, 5lbs) | HTI 1 | \$ 77 | Y | Y | Y | Y | Y |
| MEDIA-GT | Graphite Embers - Crushed Glass Media (1 bag, 5lbs) | HTI 1 | \$ 77 | Y | Y | Y | Y | Y |
| MEDIA-SM | Smoked Embers - Crushed Glass Media (1 bag, 5lbs) | HTI 1 | \$ 77 | Y | Y | Y | Y | Y |

MEDIA

| | | | | | | | | |
|-----------|---------------------------------------|-------|--------|----|----|----|----|---|
| STONES-72 | River Rock Stone Set (requires media) | HNG 1 | \$ 239 | 21 | 14 | 14 | 14 | Y |
|-----------|---------------------------------------|-------|--------|----|----|----|----|---|

| Liner Kit (Required to Complete) | | | | | | | | | | |
|--|---|-------|----|-----|----|----|----|----|----|---|
| Architectural Fiber Refractory | | | | | | | | | | |
| ACT-PR-ST | See Through Architectural Fiber Refractory | HNG 1 | \$ | 349 | Y | 14 | 14 | 14 | 14 | Y |
| Black Glass Liner - Fluted | | | | | | | | | | |
| BGK-FL-PR-ST | See Through Black Glass Liner - Fluted | HNG 1 | \$ | 459 | Y | 14 | 14 | 14 | 14 | Y |
| Black Glass Liner - Marbled | | | | | | | | | | |
| BGK-MAR-PR-ST | See Through Black Glass Liner - Marbled | HNG 1 | \$ | 459 | Y | 14 | 14 | 14 | 14 | Y |
| Black Glass Liner - Reflective | | | | | | | | | | |
| BGK-PR-ST | See Through Black Glass Liner - Reflective | HNG 1 | \$ | 459 | Y | 14 | 14 | 14 | 14 | Y |
| Column Fiber Refractory | | | | | | | | | | |
| COL-PR-ST | See Through Stone Column Fiber Refractory | HNG 1 | \$ | 349 | Y | 14 | 14 | 14 | 14 | Y |
| Venting (Required to Complete) | | | | | | | | | | |
| Insulated Flex Duct - Chimney Air Kits/Flex Duct | | | | | | | | | | |
| ID6 | 6" (152mm) insulated flex duct for use with outside air kit - includes two 42" (1065mm) sections | HTI 1 | \$ | 100 | Y | Y | Y | Y | Y | Y |
| 6" Insulated Flex Duct | | | | | | | | | | |
| FLEXDUCT6AI | 6" (152mm) insulated flex duct for outside air - 25' | HTI 1 | \$ | 100 | Y | Y | Y | Y | Y | Y |
| LP Conversion Kit | | | | | | | | | | |
| LP Conversion Kit | | | | | | | | | | |
| LPK-PRIMOII | LP Conversion Kit for Primo II Series | HNG 1 | \$ | 99 | Y | Y | Y | Y | Y | Y |
| Gas Logs - Log Set Option | | | | | | | | | | |
| Birch Logs | | | | | | | | | | |
| BIRLG-LIN-LG | 60" & 72" Birch Log Set (Requires Crushed Glass Media) | HNG 1 | \$ | 649 | Y | 14 | 14 | 14 | 14 | Y |
| Driftwood Logs | | | | | | | | | | |
| DWLG-LIN-LG | 60" & 72" Driftwood Log Set (Requires Crushed Glass Media) | HTI 1 | \$ | 649 | Y | 14 | 21 | 14 | 14 | Y |
| Traditional Logs | | | | | | | | | | |
| OAKLG-LIN-LG | 60" & 72" Traditional Log Set (Requires Crushed Glass Media) | HTI 1 | \$ | 649 | 21 | 14 | 14 | 14 | 14 | Y |
| Options & Accessories | | | | | | | | | | |
| Carry Handle | | | | | | | | | | |
| CARRY-HANDLE | Reusable Carry Handle for use with PRIMO-II (1 pcs, need 2 per unit) | HTI 1 | \$ | 179 | 14 | 14 | 14 | 14 | 14 | Y |
| Heat Management | | | | | | | | | | |
| Primo Heat Duct | | | | | | | | | | |
| PRIMO-HEAT-DUCT | Heat Zone Duct Kit - Includes Unit Collar, 10" x 4" x 6" 90 Degree Register Duct Boot, 10" x 4" White Sidewall and Ceiling Register, 25' of 6" Insulated Flex Duct | HNG 1 | \$ | 169 | Y | 14 | Y | 14 | Y | Y |
| Control, remotes, wall switches | | | | | | | | | | |
| IntelliFire app | | | | | | | | | | |
| IFT-WFM | IntelliFire Wi-Fi Module that works with the IntelliFire iOS and Android app. Use to control all the features of your fireplace via a smart device. An RC400, RC450 or RC150 is required for thermostat control | HTI 1 | \$ | 229 | Y | Y | Y | Y | Y | Y |

| IntelliFire Touch Controls - Aux Module | | | | | | | | |
|---|--|-------|--------|----|----|----|----|---|
| IFT2-PACM | IntelliFire Touch 2.0 Premium AUX Module. Controls Lights, Fans, Power Vents, HTI 1 or Heat Management. Does not include RC450 Touchscreen remote | HTI 1 | \$ 144 | 14 | 14 | 14 | 14 | Y |
| Touch Screen Remote | | | | | | | | |
| IFT2-RC450 | IntelliFire Touch 2.0 touchscreen remote and docking station. Controls flame On/Off, Lights, Fans, Heat Management, Timer, Thermostat, Flame Height, On-screen maintenance and troubleshooting notifications (IFT2-PACM sold separately) | HTI 1 | \$ 259 | 14 | 14 | 14 | 14 | Y |
| Wall Switch | | | | | | | | |
| IFT-RC150U | Universally compatible with IntelliFire Touch and IntelliFire Touch 2.0 systems. White wireless wall switch for On/Off and Cold Climate control | HTI 1 | \$ 121 | 14 | 14 | 14 | 14 | Y |



IntelliFire app

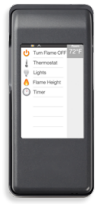

Touch Screen Remote



Wall Switch

Termination Kits

Horizontal Termination Kit

| | | | | | | | | |
|------------|---|-------|--------|---|---|---|---|---|
| HZTERM-ADP | Horizontal Termination Adaptor Kit - Includes Base and Face Trim (Required For All Horizontal Terminations, To Be Used With Standard DVP and SLP Trap Caps) | HNG 1 | \$ 169 | Y | Y | Y | Y | Y |
|------------|---|-------|--------|---|---|---|---|---|

Miscellaneous ACC

Indoor/Outdoor Kit

| | | | | | | | | |
|-----------|---|-------|--------|----|----|----|----|---|
| ODK-PR-72 | 72" Indoor/Outdoor Kit (for use with PRIMO-II-72ST, 1 kit required only when installing as an indoor/outdoor unit) (Kit does not include a window, window provided by others) | HNG 1 | \$ 629 | 14 | 14 | 14 | 14 | Y |
|-----------|---|-------|--------|----|----|----|----|---|

Venting Notes

| |
|---|
| DVP and SLP Venting Approved (DVP Starting Collar) |
| See Venting Section In Install Manual For Approved Pipe and Termination Caps |
| 6" Insulated Flex Duct For Outside Air |
| When Terminating Horizontal the HZTERM-ADP Kit Is Required Along With a Standard Trap Cap |

Heat & Glo

Fireplace - Wood - Single-Sided

Stocked Item/Lead Time
 004=Mt. Pleasant RDC
 010=Kutztown RDC
 014=Sacramento RDC
 016=Charlotte RDC
 EXP=Factory Expedite Program

Page printed 3/31/2025, 8:22:26 AM CDT
 Current pricing updated 03/30/2025
 * Please Contact Who You Purchase This Through for MSRP Pricing

Prices in USD
 Non-stock and custom product cannot be cancelled.
 Customer is responsible for freight for orders made outside of assigned RDC facility.

Exclaim 36

- Includes:
- 36" x 28 1/2" opening
 - Radiant heat
 - Insulated
 - Refractory lining
 - Colored lining
 - Ash lip
 - Safety firescreen
 - Outside air standard
 - UL listed
 - Dual gas knockouts
 - Steel grate
 - Powder coated finish
 - Attic Insulation Shield



No additional items required to complete.

| | | Disc. Code | MSRP USD | 004 IA | 010 PA | 014 CA | 016 NC | EXP |
|-------------|---|------------|----------|--------|--------|--------|--------|-----|
| EXCLAIM-36T | Exclaim 36 Wood Fireplace 36" insulated radiant heat fireplace with traditional brick styling | HNG 1 | \$ 2,259 | 8 | 14 | 14 | 14 | N |
| EXCLAIM-36H | Exclaim 36 Wood Fireplace 36" insulated radiant heat fireplace with herringbone brick styling | HNG 1 | \$ 2,319 | 8 | 14 | 14 | 14 | N |

Doors - Operable

Cottagewood Glass Doors

| | | | | | | | | |
|----------|---|-------|--------|---|----|----|----|---|
| DM6036-S | 36" stainless steel bi-fold doors for the 36" Cottagewood | HTI 3 | \$ 509 | 8 | 14 | 14 | 14 | Y |
|----------|---|-------|--------|---|----|----|----|---|

Glass Doors - Operable

Glass Bi-Fold Door

| | | | | | | | | |
|--------|--|-------|--------|---|---|---|---|---|
| DM6036 | Original bi-fold glass doors with black trim | HTI 1 | \$ 579 | Y | Y | Y | Y | Y |
|--------|--|-------|--------|---|---|---|---|---|



Glass Bi-Fold Door

Mesh Doors - Operable

Grand Vista 60

| | | | | | | | | |
|--------|--|-------|----------|---|----|----|----|---|
| GV60BK | Grand Vista cabinet style mesh doors - Black | HTI 1 | \$ 1,279 | 8 | 14 | 14 | 14 | N |
|--------|--|-------|----------|---|----|----|----|---|

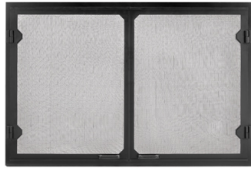

Grand Vista 60

Gas Logs - Log Set Option

Campfire Gas Log Sets

| | | | | | | | | |
|--------------|--|-------|----------|----|----|----|----|---|
| CFL-18LP-C | 18" Campfire fiber gas log set with Stainless Steel Burner and hearth kit - 60,000 Btu/Hour Input (LP). | HTI 3 | \$ 1,039 | 14 | 14 | 14 | 14 | Y |
| CFL-18NG-C | 18" Campfire fiber gas log set with Stainless Steel Burner and hearth kit - 60,000 Btu/Hour Input (NG). | HTI 3 | \$ 1,039 | 14 | 14 | 14 | 14 | Y |
| CFL-24LP-C | 24" Campfire fiber gas log set with Stainless Steel Burner and hearth kit - 60,000 Btu/Hour Input (LP) | HTI 3 | \$ 1,109 | 14 | 14 | 14 | 14 | N |
| CFL-24NG-C | 24" Campfire fiber gas log set with Stainless Steel Burner and hearth kit - 60,000 Btu/Hour Input (NG) | HTI 3 | \$ 1,109 | 14 | 14 | 14 | 14 | Y |
| CFL-24NG-IPI | 24" Campfire fiber gas log set with Stainless Steel Burner and hearth kit, IPI ignition - 60,000 Btu/Hour Input (NG) | HTI 3 | \$ 1,209 | 14 | 21 | 14 | 14 | Y |
| CFL-24LP-IPI | 24" Campfire fiber gas log set with Stainless Steel Burner and hearth kit, IPI ignition - 60,000 Btu/Hour Input (LP) | HTI 3 | \$ 1,209 | 14 | 21 | 14 | 14 | Y |

DUZY2 Logs

| | | | | | | | | |
|---------------|--|-------|--------|---|----|----|----|---|
| DUZY2LS-18-24 | 4-piece Fiber Ceramic log set for use with 18/24" Radiant Burner | HTI 3 | \$ 359 | Y | Y | 14 | Y | Y |
| DUZY2LS-30 | 4-piece Fiber Ceramic log set for use with 30" Radiant Burner | HTI 3 | \$ 429 | 8 | 14 | 14 | 14 | Y |

DUZY3 Logs

| | | | | | | | | |
|---------------|--|-------|--------|---|----|----|----|---|
| DUZY3LS-18-24 | 6-piece Refractory Cement log set for use with 18/24" Radiant Burner | HTI 3 | \$ 429 | Y | Y | 14 | Y | N |
| DUZY3LS-30 | 6-piece Refractory Cement log set for use with 30" Radiant Burner | HTI 3 | \$ 489 | Y | 14 | 14 | 14 | N |

DUZY5 Logs

| | | | | | | | | |
|---------------|--|-------|--------|---|----|----|----|---|
| DUZY5LS-18-24 | 8-piece Fiber Ceramic log set for use with 18/24" Radiant Burner | HTI 3 | \$ 489 | Y | Y | 14 | Y | Y |
| DUZY5LS-30 | 8-piece Fiber Ceramic log set for use with 30" Radiant Burner | HTI 3 | \$ 599 | 8 | 14 | 14 | 14 | Y |

Fireside Grand Oak Gas Log Sets

| | | | | | | | | |
|-----------------|--|-------|----------|----|----|----|----|---|
| GO24MTCH-HK | 24" Match Light Grand Oak Burner/Hearth Kit - 2 Tier | HTI 3 | \$ 1,029 | 21 | 21 | 14 | 21 | Y |
| GO24-IPI-LP-HK | 24" IPI Grand Oak LP Burner/Hearth Kit - 2 Tier | HTI 3 | \$ 1,329 | Y | 21 | 21 | 21 | Y |
| GO24-IPI-NG-HK | 24" IPI Grand Oak NG Burner/Hearth Kit - 2 Tier | HTI 3 | \$ 1,329 | Y | 14 | 14 | Y | Y |
| GO318-IPI-LP-HK | 18" IPI Grand Oak LP Burner/Hearth Kit - 3 Tier | HTI 3 | \$ 1,399 | 21 | 21 | 28 | 21 | Y |
| GO318-IPI-NG-HK | 18" IPI Grand Oak NG Burner/Hearth Kit - 3 Tier | HTI 3 | \$ 1,399 | 21 | 21 | 14 | 21 | Y |

Fireside Realwood Gas Log Sets

| | | | | | | | | |
|--------|---|-------|--------|----|----|---|----|---|
| FRW118 | 18" Fireside Realwood refractory cement log set (order hearth kit separately) | HTI 3 | \$ 199 | Y | 14 | Y | 14 | N |
| FRW124 | 24" Fireside Realwood refractory cement log set (order hearth kit separately) | HTI 3 | \$ 239 | 21 | 14 | Y | 21 | N |

Fireside Supreme Oak Gas Logs

| | | | | | | | | |
|-------|--|-------|--------|----|----|----|----|---|
| FSO18 | 18" Fireside Supreme Oak refractory cement log set (order hearth kit separately) | HTI 3 | \$ 509 | Y | 14 | 14 | 21 | N |
| FSO24 | 24" Fireside Supreme Oak refractory cement log set (order hearth kit separately) | HTI 3 | \$ 549 | 21 | 14 | 21 | 21 | N |

Grand Oak Logs 24

| | | | | | | | | |
|------|---------------------------------------|-------|--------|----|---|----|----|---|
| GO24 | 24" Grand Oak Log Set - 11pcs, 2 Tier | HTI 3 | \$ 449 | 21 | Y | 14 | 14 | N |
|------|---------------------------------------|-------|--------|----|---|----|----|---|

Grand Oak Logs 318

| | | | | | | | | |
|-------|---------------------------------------|-------|--------|---|----|----|----|---|
| GO318 | 18" Grand Oak Log Set - 10pcs, 3 Tier | HTI 3 | \$ 609 | Y | 21 | 14 | 21 | N |
|-------|---------------------------------------|-------|--------|---|----|----|----|---|



Campfire Gas Log Sets



DUZY2 Logs



DUZY3 Logs



DUZY5 Logs



Fireside Grand Oak Gas Log Sets



Fireside Realwood Gas Log Sets



Fireside Supreme Oak Gas Logs

Gas Logs - Burner Option Indoor

Match Light Hearth Kit

| | | | | | | | | |
|---------|--|-------|--------|---|----|----|----|---|
| MHK18NG | Hearth Kits Sand Pan Burners for Single-Sided Fireplaces 18" matchlight hearth kit - 60,000 Btu/Hour Input (NG only) | HTI 3 | \$ 279 | Y | 14 | Y | 14 | N |
| MHK24NG | Hearth Kits Sand Pan Burners for Single-Sided Fireplaces 24" matchlight hearth kit - 74,000 Btu/Hour Input (NG only) | HTI 3 | \$ 339 | Y | 14 | 21 | 21 | N |

Radiant Burner 18/24"

| | | | | | | | | |
|------------|--|-------|----------|---|---|----|---|---|
| RB-18-24PI | 18"/24" Radiant Vented Burner Assembly IPI w/remote L.P. 50,000 BTUs | HTI 3 | \$ 1,479 | Y | Y | 14 | Y | Y |
| RB-18-24NI | 18"/24" Radiant Vented Burner Assembly IPI w/remote N.G. 50,000 BTUs | HTI 3 | \$ 1,479 | Y | Y | 14 | Y | Y |

Radiant Burner 30"

| | | | | | | | | |
|---------|--|-------|----------|---|----|----|----|---|
| RB-30NI | 30" Radiant Vented Burner Assembly IPI w/remote N.G. 65,000 BTUs | HTI 3 | \$ 1,569 | Y | Y | 14 | Y | Y |
| RB-30PI | 30" Radiant Vented Burner Assembly IPI w/remote L.P. 65,000 BTUs | HTI 3 | \$ 1,569 | Y | 14 | 14 | 14 | Y |

Safety Pilot Hearth Kit

| | | | | | | | | |
|--------|---|-------|--------|----|----|----|----|---|
| SP18LP | Hearth Kits Sand Pan Burners for Single-Sided Fireplaces 18" safety pilot hearth kit - 40,000 Btu/Hour Input (LP) | HTI 3 | \$ 529 | 21 | 14 | 14 | 21 | N |
| SP18NG | Hearth Kits Sand Pan Burners for Single-Sided Fireplaces 18" safety pilot hearth kit - 60,000 Btu/Hour Input (NG) | HTI 3 | \$ 529 | Y | 14 | 14 | 14 | N |



Radiant Burner 18/24"



Radiant Burner 30"

| Floor Protector (HP) | | | | | | | | | |
|---|---|-------|----|-----|---|---|----|----|---|
| Micore Hearth Extension - Hearth Extension | | | | | | | | | |
| HX4M | Hearth extension for all size models (70"x 20"x 1/2") - pack of 5 | HTI 1 | \$ | 429 | Y | Y | Y | Y | N |
| Venting | | | | | | | | | |
| Insulated Flex Duct - Chimney Air Kits/Flex Duct | | | | | | | | | |
| ID4 | 4" (100mm) insulated flex duct for outside air - includes two 42" (1065mm) sections | HTI 1 | \$ | 87 | Y | Y | 14 | Y | Y |
| Uninsulated Flex Duct - Chimney Air Kits/Flex Duct | | | | | | | | | |
| UD4 | 4" (100mm) uninsulated flex duct for outside air - includes two 42" (1065mm) sections | HTI 1 | \$ | 56 | Y | Y | Y | Y | Y |
| SL400 Series Pipe - Term Kits & Acc - Sng Pk - Chimney Air Kits/Flex Duct | | | | | | | | | |
| CAK5A | Chimney air kit for SL1100 and SL400 series pipe (required in Canada) | HTI 1 | \$ | 142 | Y | Y | 14 | 14 | Y |
| Venting Notes | | | | | | | | | |
| U.S. uses SL1100 series chimney. Canada uses SL400 series chimney and requires SLA-10 and CAK5A | | | | | | | | | |
| See Venting section | | | | | | | | | |

Exclaim 42

Includes:

- 42" x 28 1/2" opening
- Radiant heat
- Insulated
- Refractory lining
- Colored lining
- Ash lip
- Safety firescreen
- Outside air standard
- UL listed
- Dual gas knockouts
- Steel grate
- Powder coated finish
- Attic Insulation Shield



No additional items required to complete.

| | | Disc. Code | MSRP USD | 004 IA | 010 PA | 014 CA | 016 NC | EXP |
|-------------|---|------------|----------|--------|--------|--------|--------|-----|
| EXCLAIM-42T | Exclaim 42 Wood Fireplace 42" insulated radiant heat fireplace with traditional brick styling | HNG 1 | \$ 3,029 | Y | Y | 14 | 14 | N |
| EXCLAIM-42H | Exclaim 42 Wood Fireplace 42" insulated radiant heat fireplace with herringbone brick styling | HNG 1 | \$ 3,089 | Y | 14 | 14 | 14 | N |

Doors - Operable

Cottagewood Glass Doors

| | | | | | | | | |
|----------|---|-------|--------|---|----|----|----|---|
| DM8042-S | 42" stainless steel bi-fold doors for the 42" Cottagewood | HTI 3 | \$ 649 | Y | 14 | 14 | 14 | Y |
|----------|---|-------|--------|---|----|----|----|---|

Glass Doors - Operable

Glass Bi-Fold Door

| | | | | | | | | |
|--------|--|-------|--------|---|---|---|---|---|
| DM8042 | Original bi-fold glass doors with black trim | HTI 1 | \$ 729 | Y | Y | Y | Y | Y |
|--------|--|-------|--------|---|---|---|---|---|



Glass Bi-Fold Door

Mesh Doors - Operable

Grand Vista 80

| | | | | | | | | |
|--------|--|-------|----------|---|----|----|----|---|
| GV80BK | Grand Vista cabinet style mesh doors - Black | HTI 1 | \$ 1,449 | Y | 14 | 14 | 14 | N |
|--------|--|-------|----------|---|----|----|----|---|



Grand Vista 80

Gas Logs - Log Set Option**Campfire Gas Log Sets**

| | | | | | | | | |
|--------------|--|-------|----------|----|----|----|----|---|
| CFL-18LP-C | 18" Campfire fiber gas log set with Stainless Steel Burner and hearth kit - 60,000 Btu/Hour Input (LP). | HTI 3 | \$ 1,039 | 14 | 14 | 14 | 14 | Y |
| CFL-18NG-C | 18" Campfire fiber gas log set with Stainless Steel Burner and hearth kit - 60,000 Btu/Hour Input (NG). | HTI 3 | \$ 1,039 | 14 | 14 | 14 | 14 | Y |
| CFL-24LP-C | 24" Campfire fiber gas log set with Stainless Steel Burner and hearth kit - 60,000 Btu/Hour Input (LP) | HTI 3 | \$ 1,109 | 14 | 14 | 14 | 14 | N |
| CFL-24NG-C | 24" Campfire fiber gas log set with Stainless Steel Burner and hearth kit - 60,000 Btu/Hour Input (NG) | HTI 3 | \$ 1,109 | 14 | 14 | 14 | 14 | Y |
| CFL-30LP-C | 30" Campfire fiber gas log set with Stainless Steel Burner and hearth kit - 60,000 Btu/Hour Input (LP) | HTI 3 | \$ 1,189 | 14 | 14 | 14 | 14 | N |
| CFL-30NG-C | 30" Campfire fiber gas log set with Stainless Steel Burner and hearth kit - 60,000 Btu/Hour Input (NG) | HTI 3 | \$ 1,189 | 14 | 14 | 14 | 14 | Y |
| CFL-24NG-IPI | 24" Campfire fiber gas log set with Stainless Steel Burner and hearth kit, IPI ignition - 60,000 Btu/Hour Input (NG) | HTI 3 | \$ 1,209 | 14 | 21 | 14 | 14 | Y |
| CFL-24LP-IPI | 24" Campfire fiber gas log set with Stainless Steel Burner and hearth kit, IPI ignition - 60,000 Btu/Hour Input (LP) | HTI 3 | \$ 1,209 | 14 | 21 | 14 | 14 | Y |

DUZY2 Logs

| | | | | | | | | |
|---------------|--|-------|--------|---|----|----|----|---|
| DUZY2LS-18-24 | 4-piece Fiber Ceramic log set for use with 18/24" Radiant Burner | HTI 3 | \$ 359 | Y | Y | 14 | Y | Y |
| DUZY2LS-30 | 4-piece Fiber Ceramic log set for use with 30" Radiant Burner | HTI 3 | \$ 429 | 8 | 14 | 14 | 14 | Y |

DUZY3 Logs

| | | | | | | | | |
|---------------|--|-------|--------|---|----|----|----|---|
| DUZY3LS-18-24 | 6-piece Refractory Cement log set for use with 18/24" Radiant Burner | HTI 3 | \$ 429 | Y | Y | 14 | Y | N |
| DUZY3LS-30 | 6-piece Refractory Cement log set for use with 30" Radiant Burner | HTI 3 | \$ 489 | Y | 14 | 14 | 14 | N |

DUZY5 Logs

| | | | | | | | | |
|---------------|--|-------|--------|---|----|----|----|---|
| DUZY5LS-18-24 | 8-piece Fiber Ceramic log set for use with 18/24" Radiant Burner | HTI 3 | \$ 489 | Y | Y | 14 | Y | Y |
| DUZY5LS-30 | 8-piece Fiber Ceramic log set for use with 30" Radiant Burner | HTI 3 | \$ 599 | 8 | 14 | 14 | 14 | Y |

Fireside Grand Oak Gas Log Sets

| | | | | | | | | |
|-----------------|--|-------|----------|----|----|----|----|---|
| GO24MTCH-HK | 24" Match Light Grand Oak Burner/Hearth Kit - 2 Tier | HTI 3 | \$ 1,029 | 21 | 21 | 14 | 21 | Y |
| GO30MTCH-HK | 30" Match Light Grand Oak Burner/Hearth Kit - 2 Tier | HTI 3 | \$ 1,029 | 21 | 14 | 14 | 21 | N |
| GO24-IPI-NG-HK | 24" IPI Grand Oak NG Burner/Hearth Kit - 2 Tier | HTI 3 | \$ 1,329 | Y | 14 | 14 | Y | Y |
| GO24-IPI-LP-HK | 24" IPI Grand Oak LP Burner/Hearth Kit - 2 Tier | HTI 3 | \$ 1,329 | Y | 21 | 21 | 21 | Y |
| GO30-IPI-NG-HK | 30" IPI Grand Oak NG Burner/Hearth Kit - 2 Tier | HTI 3 | \$ 1,369 | Y | 14 | 14 | 14 | N |
| GO30-IPI-LP-HK | 30" IPI Grand Oak LP Burner/Hearth Kit - 2 Tier | HTI 3 | \$ 1,369 | Y | 21 | 14 | 14 | Y |
| GO324-IPI-NG-HK | 24" IPI Grand Oak NG Burner/Hearth Kit - 3 Tier | HTI 3 | \$ 1,499 | Y | 14 | 14 | 14 | N |
| GO324-IPI-LP-HK | 24" IPI Grand Oak LP Burner/Hearth Kit - 3 Tier | HTI 3 | \$ 1,499 | 21 | 21 | 21 | 21 | Y |

Fireside Realwood Gas Log Sets

| | | | | | | | | |
|--------|---|-------|--------|----|----|---|----|---|
| FRW118 | 18" Fireside Realwood refractory cement log set (order hearth kit separately) | HTI 3 | \$ 199 | Y | 14 | Y | 14 | N |
| FRW124 | 24" Fireside Realwood refractory cement log set (order hearth kit separately) | HTI 3 | \$ 239 | 21 | 14 | Y | 21 | N |

Fireside Supreme Oak Gas Logs

| | | | | | | | | |
|-------|--|-------|--------|----|----|----|----|---|
| FSO18 | 18" Fireside Supreme Oak refractory cement log set (order hearth kit separately) | HTI 3 | \$ 509 | Y | 14 | 14 | 21 | N |
| FSO24 | 24" Fireside Supreme Oak refractory cement log set (order hearth kit separately) | HTI 3 | \$ 549 | 21 | 14 | 21 | 21 | N |
| FSO30 | 30" Fireside Supreme Oak refractory cement log set (order hearth kit separately) | HTI 3 | \$ 589 | 21 | 14 | 14 | 21 | N |

| Grand Oak Logs 24 | | | | | | | | | |
|--------------------|---------------------------------------|-------|--------|----|----|----|----|---|--|
| GO24 | 24" Grand Oak Log Set - 11pcs, 2 Tier | HTI 3 | \$ 449 | 21 | Y | 14 | 14 | N | |
| Grand Oak Logs 24 | | | | | | | | | |
| GO30 | 30" Grand Oak Log Set - 12pcs, 2 Tier | HTI 3 | \$ 539 | 21 | 21 | 14 | 14 | N | |
| Grand Oak Logs 318 | | | | | | | | | |
| GO318 | 18" Grand Oak Log Set - 10pcs, 3 Tier | HTI 3 | \$ 609 | Y | 21 | 14 | 21 | N | |
| Grand Oak Logs 324 | | | | | | | | | |
| GO324 | 24" Grand Oak Log Set - 11pcs, 3 Tier | HTI 3 | \$ 619 | 21 | 14 | 14 | Y | N | |



Campfire Gas Log Sets



DUZY2 Logs



DUZY3 Logs



DUZY5 Logs



Fireside Grand Oak Gas Log Sets



Fireside Realwood Gas Log Sets



Fireside Supreme Oak Gas Logs

Gas Logs - Burner Option Indoor

Match Light Hearth Kit

| | | | | | | | | | |
|---------|--|-------|--------|---|----|----|----|---|--|
| MHK18NG | Hearth Kits Sand Pan Burners for Single-Sided Fireplaces 18" matchlight hearth kit - 60,000 Btu/Hour Input (NG only) | HTI 3 | \$ 279 | Y | 14 | Y | 14 | N | |
| MHK24NG | Hearth Kits Sand Pan Burners for Single-Sided Fireplaces 24" matchlight hearth kit - 74,000 Btu/Hour Input (NG only) | HTI 3 | \$ 339 | Y | 14 | 21 | 21 | N | |

Radiant Burner 18/24"

| | | | | | | | | | |
|------------|--|-------|----------|---|---|----|---|---|--|
| RB-18-24PI | 18"/24" Radiant Vented Burner Assembly IPI w/remote L.P. 50,000 BTUs | HTI 3 | \$ 1,479 | Y | Y | 14 | Y | Y | |
| RB-18-24NI | 18"/24" Radiant Vented Burner Assembly IPI w/remote N.G. 50,000 BTUs | HTI 3 | \$ 1,479 | Y | Y | 14 | Y | Y | |

Radiant Burner 30"

| | | | | | | | | | |
|---------|--|-------|----------|---|----|----|----|---|--|
| RB-30NI | 30" Radiant Vented Burner Assembly IPI w/remote N.G. 65,000 BTUs | HTI 3 | \$ 1,569 | Y | Y | 14 | Y | Y | |
| RB-30PI | 30" Radiant Vented Burner Assembly IPI w/remote L.P. 65,000 BTUs | HTI 3 | \$ 1,569 | Y | 14 | 14 | 14 | Y | |

Safety Pilot Hearth Kit

| | | | | | | | | | |
|--------|---|-------|--------|----|----|----|----|---|--|
| SP18NG | Hearth Kits Sand Pan Burners for Single-Sided Fireplaces 18" safety pilot hearth kit - 60,000 Btu/Hour Input (NG) | HTI 3 | \$ 529 | Y | 14 | 14 | 14 | N | |
| SP18LP | Hearth Kits Sand Pan Burners for Single-Sided Fireplaces 18" safety pilot hearth kit - 40,000 Btu/Hour Input (LP) | HTI 3 | \$ 529 | 21 | 14 | 14 | 21 | N | |

| Safety Pilot Hearth Kit | | | | | | | | | |
|-------------------------|---|-------|----|-----|---|----|----|----|---|
| SP24LP | Hearth Kits Sand Pan Burners for Single-Sided Fireplaces 24" safety pilot hearth kit - 40,000 Btu/Hour Input (LP) | HTI 3 | \$ | 539 | Y | 14 | 14 | 21 | N |
| SP24NG | Hearth Kits Sand Pan Burners for Single-Sided Fireplaces 24" safety pilot hearth kit - 67,000 Btu/Hour Input (NG) | HTI 3 | \$ | 539 | Y | 14 | 14 | 21 | N |

| Safety Pilot Hearth Kit | | | | | | | | | |
|-------------------------|--|-------|----|-----|----|----|----|----|---|
| SP30NG | 30" safety pilot hearth kit - 80,000 Btu/Hour Input (NG) | HTI 3 | \$ | 559 | 21 | 21 | 21 | 21 | N |
| SP30LP | 30" safety pilot hearth kit - 60,000 Btu/Hour Input (LP) | HTI 3 | \$ | 559 | 21 | 21 | 21 | 14 | N |



Radiant Burner 18/24"



Radiant Burner 30"

| Floor Protector (HP) | | | | | | | | | |
|--|---|-------|----|-----|---|---|---|---|---|
| Micore Hearth Extension - Hearth Extension | | | | | | | | | |
| HX4M | Hearth extension for all size models (70"x 20"x 1/2") - pack of 5 | HTI 1 | \$ | 429 | Y | Y | Y | Y | N |

| Venting | | | | | | | | | |
|--|---|-------|----|----|---|---|----|---|---|
| Insulated Flex Duct - Chimney Air Kits/Flex Duct | | | | | | | | | |
| ID4 | 4" (100mm) insulated flex duct for outside air - includes two 42" (1065mm) sections | HTI 1 | \$ | 87 | Y | Y | 14 | Y | Y |

| Uninsulated Flex Duct - Chimney Air Kits/Flex Duct | | | | | | | | | |
|--|---|-------|----|----|---|---|---|---|---|
| UD4 | 4" (100mm) uninsulated flex duct for outside air - includes two 42" (1065mm) sections | HTI 1 | \$ | 56 | Y | Y | Y | Y | Y |

| SL400 Series Pipe - Term Kits & Acc - Sng Pk - Chimney Air Kits/Flex Duct | | | | | | | | | |
|---|---|-------|----|-----|---|---|----|----|---|
| CAK5A | Chimney air kit for SL1100 and SL400 series pipe (required in Canada) | HTI 1 | \$ | 142 | Y | Y | 14 | 14 | Y |

| Venting Notes | | | | | | | | | |
|---|--|--|--|--|--|--|--|--|--|
| U.S. uses SL1100 series chimney. Canada uses SL400 series chimney and requires SLA-10 and CAK5A | | | | | | | | | |
| See Venting section | | | | | | | | | |

Exclaim 50 (unavailable for Canadian installation)

Includes:

- 50" x 33" opening
- Radiant heat
- Insulated
- Refractory lining
- Colored lining
- Ash lip
- Safety firescreen
- Outside air standard
- UL listed
- Dual gas knockouts
- Steel grate
- Powder coated finish
- Attic Insulation Shield



No additional items required to complete.

| | | Disc. Code | MSRP USD | 004 IA | 010 PA | 014 CA | 016 NC | EXP |
|-------------|---|------------|----------|--------|--------|--------|--------|-----|
| EXCLAIM-50T | Exclaim 50 Wood Fireplace 50" insulated radiant heat fireplace with traditional brick styling | HNG 1 | \$ 4,379 | 8 | 14 | 14 | 14 | N |
| EXCLAIM-50H | Exclaim 50 Wood Fireplace 50" insulated radiant heat fireplace with herringbone brick styling | HNG 1 | \$ 4,439 | 8 | 14 | 14 | 14 | N |

Glass Doors - Operable

Glass Bi-Fold Door

| | | | | | | | | |
|-------|--|-------|----------|---|----|----|----|---|
| DM100 | Original bi-fold glass doors with black trim | HTI 1 | \$ 1,479 | Y | 14 | 14 | 14 | N |
|-------|--|-------|----------|---|----|----|----|---|



Glass Bi-Fold Door

Mesh Doors - Operable

Grand Vista 100

| | | | | | | | | |
|---------|--|-------|----------|---|----|----|----|---|
| GV100BK | Grand Vista cabinet style mesh doors - Black | HTI 1 | \$ 1,909 | 8 | 14 | 14 | 14 | N |
|---------|--|-------|----------|---|----|----|----|---|



Grand Vista 100

Gas Logs - Log Set Option**Campfire Gas Log Sets**

| | | | | | | | | |
|--------------|--|-------|----------|----|----|----|----|---|
| CFL-18NG-C | 18" Campfire fiber gas log set with Stainless Steel Burner and hearth kit - 60,000 Btu/Hour Input (NG). | HTI 3 | \$ 1,039 | 14 | 14 | 14 | 14 | Y |
| CFL-18LP-C | 18" Campfire fiber gas log set with Stainless Steel Burner and hearth kit - 60,000 Btu/Hour Input (LP). | HTI 3 | \$ 1,039 | 14 | 14 | 14 | 14 | Y |
| CFL-24LP-C | 24" Campfire fiber gas log set with Stainless Steel Burner and hearth kit - 60,000 Btu/Hour Input (LP) | HTI 3 | \$ 1,109 | 14 | 14 | 14 | 14 | N |
| CFL-24NG-C | 24" Campfire fiber gas log set with Stainless Steel Burner and hearth kit - 60,000 Btu/Hour Input (NG) | HTI 3 | \$ 1,109 | 14 | 14 | 14 | 14 | Y |
| CFL-30LP-C | 30" Campfire fiber gas log set with Stainless Steel Burner and hearth kit - 60,000 Btu/Hour Input (LP) | HTI 3 | \$ 1,189 | 14 | 14 | 14 | 14 | N |
| CFL-30NG-C | 30" Campfire fiber gas log set with Stainless Steel Burner and hearth kit - 60,000 Btu/Hour Input (NG) | HTI 3 | \$ 1,189 | 14 | 14 | 14 | 14 | Y |
| CFL-24LP-IPI | 24" Campfire fiber gas log set with Stainless Steel Burner and hearth kit, IPI ignition - 60,000 Btu/Hour Input (LP) | HTI 3 | \$ 1,209 | 14 | 21 | 14 | 14 | Y |
| CFL-24NG-IPI | 24" Campfire fiber gas log set with Stainless Steel Burner and hearth kit, IPI ignition - 60,000 Btu/Hour Input (NG) | HTI 3 | \$ 1,209 | 14 | 21 | 14 | 14 | Y |

DUZY2 Logs

| | | | | | | | | |
|---------------|--|-------|--------|---|----|----|----|---|
| DUZY2LS-18-24 | 4-piece Fiber Ceramic log set for use with 18/24" Radiant Burner | HTI 3 | \$ 359 | Y | Y | 14 | Y | Y |
| DUZY2LS-30 | 4-piece Fiber Ceramic log set for use with 30" Radiant Burner | HTI 3 | \$ 429 | 8 | 14 | 14 | 14 | Y |

DUZY3 Logs

| | | | | | | | | |
|---------------|--|-------|--------|---|----|----|----|---|
| DUZY3LS-18-24 | 6-piece Refractory Cement log set for use with 18/24" Radiant Burner | HTI 3 | \$ 429 | Y | Y | 14 | Y | N |
| DUZY3LS-30 | 6-piece Refractory Cement log set for use with 30" Radiant Burner | HTI 3 | \$ 489 | Y | 14 | 14 | 14 | N |

DUZY5 Logs

| | | | | | | | | |
|---------------|--|-------|--------|---|----|----|----|---|
| DUZY5LS-18-24 | 8-piece Fiber Ceramic log set for use with 18/24" Radiant Burner | HTI 3 | \$ 489 | Y | Y | 14 | Y | Y |
| DUZY5LS-30 | 8-piece Fiber Ceramic log set for use with 30" Radiant Burner | HTI 3 | \$ 599 | 8 | 14 | 14 | 14 | Y |

Fireside Grand Oak Gas Log Sets

| | | | | | | | | |
|-----------------|--|-------|----------|----|----|----|----|---|
| GO30MTCH-HK | 30" Match Light Grand Oak Burner/Hearth Kit - 2 Tier | HTI 3 | \$ 1,029 | 21 | 14 | 14 | 21 | N |
| GO24MTCH-HK | 24" Match Light Grand Oak Burner/Hearth Kit - 2 Tier | HTI 3 | \$ 1,029 | 21 | 21 | 14 | 21 | Y |
| GO24-IPI-NG-HK | 24" IPI Grand Oak NG Burner/Hearth Kit - 2 Tier | HTI 3 | \$ 1,329 | Y | 14 | 14 | Y | Y |
| GO24-IPI-LP-HK | 24" IPI Grand Oak LP Burner/Hearth Kit - 2 Tier | HTI 3 | \$ 1,329 | Y | 21 | 21 | 21 | Y |
| GO30-IPI-NG-HK | 30" IPI Grand Oak NG Burner/Hearth Kit - 2 Tier | HTI 3 | \$ 1,369 | Y | 14 | 14 | 14 | N |
| GO30-IPI-LP-HK | 30" IPI Grand Oak LP Burner/Hearth Kit - 2 Tier | HTI 3 | \$ 1,369 | Y | 21 | 14 | 14 | Y |
| GO330-IPI-LP-HK | 30" IPI Grand Oak LP Burner/Hearth Kit - 3 Tier | HTI 3 | \$ 1,549 | Y | 21 | 14 | 14 | N |
| GO330-IPI-NG-HK | 30" IPI Grand Oak NG Burner/Hearth Kit - 3 Tier | HTI 3 | \$ 1,549 | Y | 21 | 21 | 14 | N |

Fireside Realwood Gas Log Sets

| | | | | | | | | |
|--------|---|-------|--------|----|----|---|----|---|
| FRW118 | 18" Fireside Realwood refractory cement log set (order hearth kit separately) | HTI 3 | \$ 199 | Y | 14 | Y | 14 | N |
| FRW124 | 24" Fireside Realwood refractory cement log set (order hearth kit separately) | HTI 3 | \$ 239 | 21 | 14 | Y | 21 | N |

Fireside Supreme Oak Gas Logs

| | | | | | | | | |
|-------|--|-------|--------|----|----|----|----|---|
| FSO18 | 18" Fireside Supreme Oak refractory cement log set (order hearth kit separately) | HTI 3 | \$ 509 | Y | 14 | 14 | 21 | N |
| FSO24 | 24" Fireside Supreme Oak refractory cement log set (order hearth kit separately) | HTI 3 | \$ 549 | 21 | 14 | 21 | 21 | N |
| FSO30 | 30" Fireside Supreme Oak refractory cement log set (order hearth kit separately) | HTI 3 | \$ 589 | 21 | 14 | 14 | 21 | N |

| Grand Oak Logs 24 | | | | | | | | | |
|--------------------|---------------------------------------|-------|--------|----|----|----|----|---|--|
| GO24 | 24" Grand Oak Log Set - 11pcs, 2 Tier | HTI 3 | \$ 449 | 21 | Y | 14 | 14 | N | |
| Grand Oak Logs 24 | | | | | | | | | |
| GO30 | 30" Grand Oak Log Set - 12pcs, 2 Tier | HTI 3 | \$ 539 | 21 | 21 | 14 | 14 | N | |
| Grand Oak Logs 330 | | | | | | | | | |
| GO330 | 30" Grand Oak Log Set - 12pcs, 3 Tier | HTI 3 | \$ 689 | Y | 21 | 14 | 14 | N | |



Campfire Gas Log Sets



DUZY2 Logs



DUZY3 Logs



DUZY5 Logs



Fireside Grand Oak Gas Log Sets



Fireside Realwood Gas Log Sets



Fireside Supreme Oak Gas Logs

Gas Logs - Burner Option Indoor

Match Light Hearth Kit

| | | | | | | | | | |
|---------|--|-------|--------|---|----|----|----|---|--|
| MHK18NG | Hearth Kits Sand Pan Burners for Single-Sided Fireplaces 18" matchlight hearth kit - 60,000 Btu/Hour Input (NG only) | HTI 3 | \$ 279 | Y | 14 | Y | 14 | N | |
| MHK24NG | Hearth Kits Sand Pan Burners for Single-Sided Fireplaces 24" matchlight hearth kit - 74,000 Btu/Hour Input (NG only) | HTI 3 | \$ 339 | Y | 14 | 21 | 21 | N | |

Radiant Burner 18/24"

| | | | | | | | | | |
|------------|--|-------|----------|---|---|----|---|---|--|
| RB-18-24PI | 18"/24" Radiant Vented Burner Assembly IPI w/remote L.P. 50,000 BTUs | HTI 3 | \$ 1,479 | Y | Y | 14 | Y | Y | |
| RB-18-24NI | 18"/24" Radiant Vented Burner Assembly IPI w/remote N.G. 50,000 BTUs | HTI 3 | \$ 1,479 | Y | Y | 14 | Y | Y | |

Radiant Burner 30"

| | | | | | | | | | |
|---------|--|-------|----------|---|----|----|----|---|--|
| RB-30PI | 30" Radiant Vented Burner Assembly IPI w/remote L.P. 65,000 BTUs | HTI 3 | \$ 1,569 | Y | 14 | 14 | 14 | Y | |
| RB-30NI | 30" Radiant Vented Burner Assembly IPI w/remote N.G. 65,000 BTUs | HTI 3 | \$ 1,569 | Y | Y | 14 | Y | Y | |

Safety Pilot Hearth Kit

| | | | | | | | | | |
|--------|---|-------|--------|----|----|----|----|---|--|
| SP18NG | Hearth Kits Sand Pan Burners for Single-Sided Fireplaces 18" safety pilot hearth kit - 60,000 Btu/Hour Input (NG) | HTI 3 | \$ 529 | Y | 14 | 14 | 14 | N | |
| SP18LP | Hearth Kits Sand Pan Burners for Single-Sided Fireplaces 18" safety pilot hearth kit - 40,000 Btu/Hour Input (LP) | HTI 3 | \$ 529 | 21 | 14 | 14 | 21 | N | |

Safety Pilot Hearth Kit

| | | | | | | | | | |
|--------|---|-------|--------|---|----|----|----|---|--|
| SP24LP | Hearth Kits Sand Pan Burners for Single-Sided Fireplaces 24" safety pilot hearth kit - 40,000 Btu/Hour Input (LP) | HTI 3 | \$ 539 | Y | 14 | 14 | 21 | N | |
| SP24NG | Hearth Kits Sand Pan Burners for Single-Sided Fireplaces 24" safety pilot hearth kit - 67,000 Btu/Hour Input (NG) | HTI 3 | \$ 539 | Y | 14 | 14 | 21 | N | |

Safety Pilot Hearth Kit

| | | | | | | | | |
|--------|--|-------|--------|----|----|----|----|---|
| SP30NG | 30" safety pilot hearth kit - 80,000 Btu/Hour Input (NG) | HTI 3 | \$ 559 | 21 | 21 | 21 | 21 | N |
| SP30LP | 30" safety pilot hearth kit - 60,000 Btu/Hour Input (LP) | HTI 3 | \$ 559 | 21 | 21 | 21 | 14 | N |



Radiant Burner 18/24"



Radiant Burner 30"

Floor Protector (HP)

Micore Hearth Extension - Hearth Extension

| | | | | | | | | |
|------|---|-------|--------|---|---|---|---|---|
| HX4M | Hearth extension for all size models (70"x 20"x 1/2") - pack of 5 | HTI 1 | \$ 429 | Y | Y | Y | Y | N |
|------|---|-------|--------|---|---|---|---|---|

Venting

Insulated Flex Duct - Chimney Air Kits/Flex Duct

| | | | | | | | | |
|-----|---|-------|-------|---|---|----|---|---|
| ID4 | 4" (100mm) insulated flex duct for outside air - includes two 42" (1065mm) sections | HTI 1 | \$ 87 | Y | Y | 14 | Y | Y |
|-----|---|-------|-------|---|---|----|---|---|

Uninsulated Flex Duct - Chimney Air Kits/Flex Duct

| | | | | | | | | |
|-----|---|-------|-------|---|---|---|---|---|
| UD4 | 4" (100mm) uninsulated flex duct for outside air - includes two 42" (1065mm) sections | HTI 1 | \$ 56 | Y | Y | Y | Y | Y |
|-----|---|-------|-------|---|---|---|---|---|

SL400 Series Pipe - Term Kits & Acc - Sng Pk - Chimney Air Kits/Flex Duct

| | | | | | | | | |
|-------|---|-------|--------|---|---|----|----|---|
| CAK5A | Chimney air kit for SL1100 and SL400 series pipe (required in Canada) | HTI 1 | \$ 142 | Y | Y | 14 | 14 | Y |
|-------|---|-------|--------|---|---|----|----|---|

Venting Notes

Requires SL1100 series pipe. See Venting section
 Model not approved for use in Canada

Northstar

Includes:

- Up to 68,200 Btu/Hour
- Ceramic glass
- Junction box
- Dual fans
- Arched steel face
- CAK4A
- Outside air hood
- Lined with firebrick
- Cast iron door and grilles
- Attic Insulation Shield



Special Considerations:

- Advanced Install Product training required before product ships
- Certified to 2020 EPA emissions standards

No additional items required to complete.

| | | Disc. | MSRP | 004 | 010 | 014 | 016 | EXP |
|-------------|---|-------|----------|-----|-----|-----|-----|-----|
| | | Code | USD | IA | PA | CA | NC | |
| NORTHSTAR-D | Wood fireplace with black cabinet style doors | HNG 3 | \$ 6,389 | Y | Y | Y | Y | N |

Options & Accessories

Finishing Template

| | | | | | | | | |
|-------------|-----------------------------------|-------|--------|---|----|----|----|---|
| TMP-MED-ARC | Metal Finishing Template - Arched | HTI 3 | \$ 199 | Y | 14 | 14 | 14 | Y |
|-------------|-----------------------------------|-------|--------|---|----|----|----|---|

Firescreen Mesh

| | | | | | | | | |
|------------|------------|-------|--------|---|----|----|----|---|
| MESH-HHT-C | Firescreen | HTI 3 | \$ 309 | Y | 14 | 14 | 14 | Y |
|------------|------------|-------|--------|---|----|----|----|---|

Lintel Bar

| | | | | | | | | |
|---------------|------------|-------|--------|---|----|----|----|---|
| LINTELBAR-HHT | Lintel bar | HTI 1 | \$ 359 | 8 | 21 | 14 | 14 | Y |
|---------------|------------|-------|--------|---|----|----|----|---|

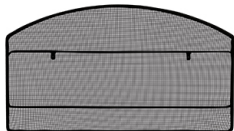

Firescreen Mesh

Heat Management

Heat Zone Kit

| | | | | | | | | |
|----------------|--|-------|--------|---|---|---|---|---|
| HEAT-ZONE-WD-C | Heat distribution kit (includes fan, grille cover, fireplace adaptor, and adjustment control) requires 6" vent for ducting | HTI 1 | \$ 399 | Y | Y | Y | Y | Y |
|----------------|--|-------|--------|---|---|---|---|---|

Floor Protector (HP)

Micore Hearth Extension - Hearth Extension

| | | | | | | | | |
|------|---|-------|--------|---|---|---|---|---|
| HX4M | Hearth extension for all size models (70"x 20"x 1/2") - pack of 5 | HTI 1 | \$ 429 | Y | Y | Y | Y | N |
|------|---|-------|--------|---|---|---|---|---|

Venting

Outside Air Kit

| | | | | | | | | |
|---------|--|-------|-------|---|----|----|----|---|
| OA-RD-6 | Outside air elbow kit (used to offset outside air starting collar) | HTI 1 | \$ 60 | Y | 14 | 14 | 14 | Y |
|---------|--|-------|-------|---|----|----|----|---|

Venting Notes

Requires SL300 or 8" DuraPlus pipe with the DuraPlus base plate. See venting section

When using 8" DuraPlus use DV-6DP-IS attic insulation shield

Royal Hearth 36

Includes:

- 36" x 21" opening
- Radiant heat
- Safety firescreen
- Refractory lining
- Colored refractory
- Ash lip
- Steel grate
- Front access damper handle - handle on second line
- Dual gas knockouts
- Powder coated finish
- UL listed
- Attic Insulation Shield



No additional items required to complete.

| | | Disc. Code | MSRP USD | 004 IA | 010 PA | 014 CA | 016 NC | EXP |
|-------|---|------------|----------|--------|--------|--------|--------|-----|
| RH-36 | Royal Hearth 36 Wood Fireplace 36" woodburning radiant w/ traditional brick | HNG 1 | \$ 1,239 | Y | Y | Y | Y | N |

Glass Doors - Operable

Glass Bi-Fold Door

| | | | | | | | | |
|---------|--|-------|--------|---|----|----|----|---|
| DM1036 | Original bi-fold glass doors with black trim | HTI 1 | \$ 539 | Y | Y | Y | Y | Y |
| DM1036S | Original bi-fold glass doors with stainless steel trim | HTI 1 | \$ 589 | 8 | 14 | 14 | 14 | Y |



Glass Bi-Fold Door

Gas Logs - Log Set Option

DUZY2 Logs

| | | | | | | | | |
|---------------|--|-------|--------|---|----|----|----|---|
| DUZY2LS-18-24 | 4-piece Fiber Ceramic log set for use with 18/24" Radiant Burner | HTI 3 | \$ 359 | Y | Y | 14 | Y | Y |
| DUZY2LS-30 | 4-piece Fiber Ceramic log set for use with 30" Radiant Burner | HTI 3 | \$ 429 | 8 | 14 | 14 | 14 | Y |

DUZY3 Logs

| | | | | | | | | |
|---------------|--|-------|--------|---|----|----|----|---|
| DUZY3LS-18-24 | 6-piece Refractory Cement log set for use with 18/24" Radiant Burner | HTI 3 | \$ 429 | Y | Y | 14 | Y | N |
| DUZY3LS-30 | 6-piece Refractory Cement log set for use with 30" Radiant Burner | HTI 3 | \$ 489 | Y | 14 | 14 | 14 | N |

DUZY5 Logs

| | | | | | | | | |
|---------------|--|-------|--------|---|----|----|----|---|
| DUZY5LS-18-24 | 8-piece Fiber Ceramic log set for use with 18/24" Radiant Burner | HTI 3 | \$ 489 | Y | Y | 14 | Y | Y |
| DUZY5LS-30 | 8-piece Fiber Ceramic log set for use with 30" Radiant Burner | HTI 3 | \$ 599 | 8 | 14 | 14 | 14 | Y |

Fireside Realwood Gas Log Sets

| | | | | | | | | |
|--------|---|-------|--------|----|----|---|----|---|
| FRW118 | 18" Fireside Realwood refractory cement log set (order hearth kit separately) | HTI 3 | \$ 199 | Y | 14 | Y | 14 | N |
| FRW124 | 24" Fireside Realwood refractory cement log set (order hearth kit separately) | HTI 3 | \$ 239 | 21 | 14 | Y | 21 | N |

| Fireside Supreme Oak Gas Logs | | | | | | | | | |
|-------------------------------|--|-------|----|-----|----|----|----|----|---|
| FSO18 | 18" Fireside Supreme Oak refractory cement log set (order hearth kit separately) | HTI 3 | \$ | 509 | Y | 14 | 14 | 21 | N |
| FSO24 | 24" Fireside Supreme Oak refractory cement log set (order hearth kit separately) | HTI 3 | \$ | 549 | 21 | 14 | 21 | 21 | N |
| FSO30 | 30" Fireside Supreme Oak refractory cement log set (order hearth kit separately) | HTI 3 | \$ | 589 | 21 | 14 | 14 | 21 | N |



DUZY2 Logs



DUZY3 Logs



DUZY5 Logs



Fireside Realwood Gas Log Sets



Fireside Supreme Oak Gas Logs

Gas Logs - Burner Option Indoor

Match Light Hearth Kit

| | | | | | | | | | |
|---------|--|-------|----|-----|---|----|----|----|---|
| MHK18NG | Hearth Kits Sand Pan Burners for Single-Sided Fireplaces 18" matchlight hearth kit - 60,000 Btu/Hour Input (NG only) | HTI 3 | \$ | 279 | Y | 14 | Y | 14 | N |
| MHK24NG | Hearth Kits Sand Pan Burners for Single-Sided Fireplaces 24" matchlight hearth kit - 74,000 Btu/Hour Input (NG only) | HTI 3 | \$ | 339 | Y | 14 | 21 | 21 | N |

Radiant Burner 18/24"

| | | | | | | | | | |
|------------|--|-------|----|-------|---|---|----|---|---|
| RB-18-24PI | 18"/24" Radiant Vented Burner Assembly IPI w/remote L.P. 50,000 BTUs | HTI 3 | \$ | 1,479 | Y | Y | 14 | Y | Y |
| RB-18-24NI | 18"/24" Radiant Vented Burner Assembly IPI w/remote N.G. 50,000 BTUs | HTI 3 | \$ | 1,479 | Y | Y | 14 | Y | Y |

Radiant Burner 30"

| | | | | | | | | | |
|---------|--|-------|----|-------|---|----|----|----|---|
| RB-30NI | 30" Radiant Vented Burner Assembly IPI w/remote N.G. 65,000 BTUs | HTI 3 | \$ | 1,569 | Y | Y | 14 | Y | Y |
| RB-30PI | 30" Radiant Vented Burner Assembly IPI w/remote L.P. 65,000 BTUs | HTI 3 | \$ | 1,569 | Y | 14 | 14 | 14 | Y |

Safety Pilot Hearth Kit

| | | | | | | | | | |
|--------|---|-------|----|-----|----|----|----|----|---|
| SP18NG | Hearth Kits Sand Pan Burners for Single-Sided Fireplaces 18" safety pilot hearth kit - 60,000 Btu/Hour Input (NG) | HTI 3 | \$ | 529 | Y | 14 | 14 | 14 | N |
| SP18LP | Hearth Kits Sand Pan Burners for Single-Sided Fireplaces 18" safety pilot hearth kit - 40,000 Btu/Hour Input (LP) | HTI 3 | \$ | 529 | 21 | 14 | 14 | 21 | N |



Radiant Burner 18/24"

Radiant Burner 30"

Options & Accessories

Outside Air Kit

| | | | | | | | | | |
|------|--|-------|----|----|---|---|---|---|---|
| AK24 | Outside air kit (1 each) - Flex Venting not included | HTI 1 | \$ | 17 | Y | Y | Y | Y | Y |
|------|--|-------|----|----|---|---|---|---|---|

Heat Wrap insulated blanket

Heat Wrap Blanket

| | | | | | | | | | |
|--------|-----------------------------|-------|----|-----|---|----|----|----|---|
| HW8040 | Heat Wrap insulated blanket | HTI 1 | \$ | 149 | 8 | 21 | 14 | 14 | Y |
|--------|-----------------------------|-------|----|-----|---|----|----|----|---|

Floor Protector (HP)

Micore Hearth Extension - Hearth Extension

| | | | | | | | | | |
|------|---|-------|----|-----|---|---|---|---|---|
| HX4M | Hearth extension for all size models (70"x 20"x 1/2") - pack of 5 | HTI 1 | \$ | 429 | Y | Y | Y | Y | N |
|------|---|-------|----|-----|---|---|---|---|---|

Venting

Insulated Flex Duct - Chimney Air Kits/Flex Duct

| | | | | | | | | | |
|-----|---|-------|----|----|---|---|----|---|---|
| ID4 | 4" (100mm) insulated flex duct for outside air - includes two 42" (1065mm) sections | HTI 1 | \$ | 87 | Y | Y | 14 | Y | Y |
|-----|---|-------|----|----|---|---|----|---|---|

Uninsulated Flex Duct - Chimney Air Kits/Flex Duct

| | | | | | | | | | |
|-----|---|-------|----|----|---|---|---|---|---|
| UD4 | 4" (100mm) uninsulated flex duct for outside air - includes two 42" (1065mm) sections | HTI 1 | \$ | 56 | Y | Y | Y | Y | Y |
|-----|---|-------|----|----|---|---|---|---|---|

SL300 Series Pipe - Comp - SngPk - Chimney Air Kits/Flex Duct Dimensions: 8" Inner / 10.5" Outer

| | | | | | | | | | |
|-------|---|-------|----|-----|---|---|----|----|---|
| CAK4A | Chimney air kit (for SL300 series chimney systems only) | HTI 1 | \$ | 126 | Y | Y | 14 | 14 | Y |
|-------|---|-------|----|-----|---|---|----|----|---|

Venting Notes

Requires SL300 series chimney. See Venting section

Royal Hearth 42

Includes:

- 42" x 21" opening
- Radiant heat
- Refractory lining
- Colored refractory
- Ash lip
- Safety firescreen
- Steel grate
- Front access damper handle - handle on second line
- Dual gas knockouts
- UL listed
- Powder coated finish
- Attic Insulation Shield



No additional items required to complete.

| | | Disc. Code | MSRP USD | 004 IA | 010 PA | 014 CA | 016 NC | EXP |
|-------|--|------------|----------|--------|--------|--------|--------|-----|
| RH-42 | Royal Hearth 42 Wood Fireplace 42" radiant heat with traditional brick | HNG 1 | \$ 1,899 | Y | Y | Y | Y | N |

Glass Doors - Operable

Glass Bi-Fold Door

| | | | | | | | | |
|---------|--|-------|--------|----|----|----|----|---|
| DM1042 | Original bi-fold glass doors with black trim | HTI 1 | \$ 669 | Y | Y | Y | Y | Y |
| DM1042S | Original bi-fold glass doors with stainless steel trim | HTI 1 | \$ 719 | 14 | 14 | 14 | 14 | Y |



Glass Bi-Fold Door

Gas Logs - Log Set Option

Campfire Gas Log Sets

| | | | | | | | | |
|------------|--|-------|----------|----|----|----|----|---|
| CFL-24LP-C | 24" Campfire fiber gas log set with Stainless Steel Burner and hearth kit - 60,000 Btu/Hour Input (LP) | HTI 3 | \$ 1,109 | 14 | 14 | 14 | 14 | N |
|------------|--|-------|----------|----|----|----|----|---|

DUZY2 Logs

| | | | | | | | | |
|---------------|--|-------|--------|---|----|----|----|---|
| DUZY2LS-18-24 | 4-piece Fiber Ceramic log set for use with 18/24" Radiant Burner | HTI 3 | \$ 359 | Y | Y | 14 | Y | Y |
| DUZY2LS-30 | 4-piece Fiber Ceramic log set for use with 30" Radiant Burner | HTI 3 | \$ 429 | 8 | 14 | 14 | 14 | Y |

DUZY3 Logs

| | | | | | | | | |
|---------------|--|-------|--------|---|----|----|----|---|
| DUZY3LS-18-24 | 6-piece Refractory Cement log set for use with 18/24" Radiant Burner | HTI 3 | \$ 429 | Y | Y | 14 | Y | N |
| DUZY3LS-30 | 6-piece Refractory Cement log set for use with 30" Radiant Burner | HTI 3 | \$ 489 | Y | 14 | 14 | 14 | N |

DUZY5 Logs

| | | | | | | | | |
|---------------|--|-------|--------|---|----|----|----|---|
| DUZY5LS-18-24 | 8-piece Fiber Ceramic log set for use with 18/24" Radiant Burner | HTI 3 | \$ 489 | Y | Y | 14 | Y | Y |
| DUZY5LS-30 | 8-piece Fiber Ceramic log set for use with 30" Radiant Burner | HTI 3 | \$ 599 | 8 | 14 | 14 | 14 | Y |

Fireside Realwood Gas Log Sets

| | | | | | | | | |
|--------|---|-------|--------|----|----|---|----|---|
| FRW118 | 18" Fireside Realwood refractory cement log set (order hearth kit separately) | HTI 3 | \$ 199 | Y | 14 | Y | 14 | N |
| FRW124 | 24" Fireside Realwood refractory cement log set (order hearth kit separately) | HTI 3 | \$ 239 | 21 | 14 | Y | 21 | N |

| Fireside Supreme Oak Gas Logs | | | | | | | | | |
|-------------------------------|--|-------|----|-----|----|----|----|----|---|
| FSO18 | 18" Fireside Supreme Oak refractory cement log set (order hearth kit separately) | HTI 3 | \$ | 509 | Y | 14 | 14 | 21 | N |
| FSO24 | 24" Fireside Supreme Oak refractory cement log set (order hearth kit separately) | HTI 3 | \$ | 549 | 21 | 14 | 21 | 21 | N |
| FSO30 | 30" Fireside Supreme Oak refractory cement log set (order hearth kit separately) | HTI 3 | \$ | 589 | 21 | 14 | 14 | 21 | N |



Campfire Gas Log Sets



DUZY2 Logs



DUZY3 Logs



DUZY5 Logs



Fireside Realwood Gas Log Sets



Fireside Supreme Oak Gas Logs

Gas Logs - Burner Option Indoor

Match Light Hearth Kit

| | | | | | | | | | |
|---------|--|-------|----|-----|---|----|----|----|---|
| MHK18NG | Hearth Kits Sand Pan Burners for Single-Sided Fireplaces 18" matchlight hearth kit - 60,000 Btu/Hour Input (NG only) | HTI 3 | \$ | 279 | Y | 14 | Y | 14 | N |
| MHK24NG | Hearth Kits Sand Pan Burners for Single-Sided Fireplaces 24" matchlight hearth kit - 74,000 Btu/Hour Input (NG only) | HTI 3 | \$ | 339 | Y | 14 | 21 | 21 | N |

Radiant Burner 18/24"

| | | | | | | | | | |
|------------|--|-------|----|-------|---|---|----|---|---|
| RB-18-24PI | 18"/24" Radiant Vented Burner Assembly IPI w/remote L.P. 50,000 BTUs | HTI 3 | \$ | 1,479 | Y | Y | 14 | Y | Y |
| RB-18-24NI | 18"/24" Radiant Vented Burner Assembly IPI w/remote N.G. 50,000 BTUs | HTI 3 | \$ | 1,479 | Y | Y | 14 | Y | Y |

Radiant Burner 30"

| | | | | | | | | | |
|---------|--|-------|----|-------|---|----|----|----|---|
| RB-30PI | 30" Radiant Vented Burner Assembly IPI w/remote L.P. 65,000 BTUs | HTI 3 | \$ | 1,569 | Y | 14 | 14 | 14 | Y |
| RB-30NI | 30" Radiant Vented Burner Assembly IPI w/remote N.G. 65,000 BTUs | HTI 3 | \$ | 1,569 | Y | Y | 14 | Y | Y |

Safety Pilot Hearth Kit

| | | | | | | | | | |
|--------|---|-------|----|-----|----|----|----|----|---|
| SP18LP | Hearth Kits Sand Pan Burners for Single-Sided Fireplaces 18" safety pilot hearth kit - 40,000 Btu/Hour Input (LP) | HTI 3 | \$ | 529 | 21 | 14 | 14 | 21 | N |
| SP18NG | Hearth Kits Sand Pan Burners for Single-Sided Fireplaces 18" safety pilot hearth kit - 60,000 Btu/Hour Input (NG) | HTI 3 | \$ | 529 | Y | 14 | 14 | 14 | N |

Safety Pilot Hearth Kit

| | | | | | | | | | |
|--------|---|-------|----|-----|---|----|----|----|---|
| SP24LP | Hearth Kits Sand Pan Burners for Single-Sided Fireplaces 24" safety pilot hearth kit - 40,000 Btu/Hour Input (LP) | HTI 3 | \$ | 539 | Y | 14 | 14 | 21 | N |
| SP24NG | Hearth Kits Sand Pan Burners for Single-Sided Fireplaces 24" safety pilot hearth kit - 67,000 Btu/Hour Input (NG) | HTI 3 | \$ | 539 | Y | 14 | 14 | 21 | N |



Radiant Burner 18/24"



Radiant Burner 30"

Options & Accessories

Outside Air Kit

| | | | | | | | | | |
|------|--|-------|----|----|---|---|---|---|---|
| AK24 | Outside air kit (1 each) - Flex Venting not included | HTI 1 | \$ | 17 | Y | Y | Y | Y | Y |
|------|--|-------|----|----|---|---|---|---|---|

Heat Wrap insulated blanket

Heat Wrap Blanket

| | | | | | | | | | |
|--------|-----------------------------|-------|----|-----|---|----|----|----|---|
| HW8040 | Heat Wrap insulated blanket | HTI 1 | \$ | 149 | 8 | 21 | 14 | 14 | Y |
|--------|-----------------------------|-------|----|-----|---|----|----|----|---|

Floor Protector (HP)

Micore Hearth Extension - Hearth Extension

| | | | | | | | | | |
|------|---|-------|----|-----|---|---|---|---|---|
| HX4M | Hearth extension for all size models (70"x 20"x 1/2") - pack of 5 | HTI 1 | \$ | 429 | Y | Y | Y | Y | N |
|------|---|-------|----|-----|---|---|---|---|---|

Venting

Insulated Flex Duct - Chimney Air Kits/Flex Duct

| | | | | | | | | | |
|-----|---|-------|----|----|---|---|----|---|---|
| ID4 | 4" (100mm) insulated flex duct for outside air - includes two 42" (1065mm) sections | HTI 1 | \$ | 87 | Y | Y | 14 | Y | Y |
|-----|---|-------|----|----|---|---|----|---|---|

Uninsulated Flex Duct - Chimney Air Kits/Flex Duct

| | | | | | | | | | |
|-----|---|-------|----|----|---|---|---|---|---|
| UD4 | 4" (100mm) uninsulated flex duct for outside air - includes two 42" (1065mm) sections | HTI 1 | \$ | 56 | Y | Y | Y | Y | Y |
|-----|---|-------|----|----|---|---|---|---|---|

SL300 Series Pipe - Comp - SngPk - Chimney Air Kits/Flex Duct Dimensions: 8" Inner / 10.5" Outer

| | | | | | | | | | |
|-------|---|-------|----|-----|---|---|----|----|---|
| CAK4A | Chimney air kit (for SL300 series chimney systems only) | HTI 1 | \$ | 126 | Y | Y | 14 | 14 | Y |
|-------|---|-------|----|-----|---|---|----|----|---|

Venting Notes

Requires SL300 series chimney. See Venting section

Rutherford 36

Includes:

- 36" x 38" opening
- Radiant heat
- Andirons
- Outside air standard
- UL listed
- Dual gas knockouts
- Steel grate
- Safety firescreen
- Attic insulation shield



Special Considerations:

- When ordering Firebrick Yellow molded brick panels, SRV4059-693 is recommended for matching hearth

Required to Complete - Sold Separately: • Molded brick panel

| | | Disc. | MSRP | 004 | 010 | 014 | 016 | EXP |
|-----------------|--|-------|----------|-----|-----|-----|-----|-----|
| | | Code | USD | IA | PA | CA | NC | |
| RUTHERFORD-36-B | Rutherford 36 Wood Fireplace 36" radiant heat unit with Natural Gray Hearth Refractory | HNG 1 | \$ 3,319 | 8 | 14 | 14 | 14 | N |

Refractory (Required to Complete)

Herringbone

| | | | | | | | | |
|----------|--|-------|----------|---|----|----|----|---|
| MMHB36-B | Firebrick Yellow Molded brick panels - herringbone | HTI 1 | \$ 1,389 | 8 | 14 | 14 | 14 | N |
|----------|--|-------|----------|---|----|----|----|---|

Refractory

| | | | | | | | | |
|---------|--|-------|----------|---|----|----|----|---|
| AMMTB36 | Natural Gray Molded brick panels - Traditional | HTI 1 | \$ 1,029 | 8 | 14 | 14 | Y | N |
| AMMHB36 | Natural Gray Molded brick panels - Herringbone | HTI 1 | \$ 1,389 | Y | 14 | 14 | 14 | N |

Traditional

| | | | | | | | | |
|----------|--|-------|----------|---|----|----|----|---|
| MMTB36-B | Firebrick Yellow Molded brick panels - traditional | HTI 1 | \$ 1,029 | 8 | 21 | 14 | 14 | N |
|----------|--|-------|----------|---|----|----|----|---|

Glass Doors - Operable

Glass Bi-Fold Door

| | | | | | | | | |
|-----------|---------------------------|-------|----------|---|----|----|----|---|
| DFG4036BK | Glass bi-fold door, black | HTI 1 | \$ 1,679 | 8 | 14 | 14 | 14 | N |
|-----------|---------------------------|-------|----------|---|----|----|----|---|



Glass Bi-Fold Door

Gas Logs - Log Set Option

DUZY2 Logs

| | | | | | | | | |
|---------------|--|-------|--------|---|----|----|----|---|
| DUZY2LS-18-24 | 4-piece Fiber Ceramic log set for use with 18/24" Radiant Burner | HTI 3 | \$ 359 | Y | Y | 14 | Y | Y |
| DUZY2LS-30 | 4-piece Fiber Ceramic log set for use with 30" Radiant Burner | HTI 3 | \$ 429 | 8 | 14 | 14 | 14 | Y |

DUZY3 Logs

| | | | | | | | | |
|---------------|--|-------|--------|---|----|----|----|---|
| DUZY3LS-18-24 | 6-piece Refractory Cement log set for use with 18/24" Radiant Burner | HTI 3 | \$ 429 | Y | Y | 14 | Y | N |
| DUZY3LS-30 | 6-piece Refractory Cement log set for use with 30" Radiant Burner | HTI 3 | \$ 489 | Y | 14 | 14 | 14 | N |

| DUZY5 Logs | | | | | | | | | |
|---------------|--|-------|--------|---|----|----|----|---|--|
| DUZY5LS-18-24 | 8-piece Fiber Ceramic log set for use with 18/24" Radiant Burner | HTI 3 | \$ 489 | Y | Y | 14 | Y | Y | |
| DUZY5LS-30 | 8-piece Fiber Ceramic log set for use with 30" Radiant Burner | HTI 3 | \$ 599 | 8 | 14 | 14 | 14 | Y | |

| Fireside Grand Oak Gas Log Sets | | | | | | | | | |
|---------------------------------|---|-------|----------|----|----|----|----|---|--|
| GO318-IPI-NG-HK | 18" IPI Grand Oak NG Burner/Hearth Kit - 3 Tier | HTI 3 | \$ 1,399 | 21 | 21 | 14 | 21 | Y | |
| GO318-IPI-LP-HK | 18" IPI Grand Oak LP Burner/Hearth Kit - 3 Tier | HTI 3 | \$ 1,399 | 21 | 21 | 28 | 21 | Y | |

| Grand Oak Logs 318 | | | | | | | | | |
|--------------------|---------------------------------------|-------|--------|---|----|----|----|---|--|
| GO318 | 18" Grand Oak Log Set - 10pcs, 3 Tier | HTI 3 | \$ 609 | Y | 21 | 14 | 21 | N | |



DUZY2 Logs



DUZY3 Logs



DUZY5 Logs



Fireside Grand Oak Gas Log Sets

Gas Logs - Burner Option Indoor

Radiant Burner 18/24"

| | | | | | | | | | |
|------------|--|-------|----------|---|---|----|---|---|--|
| RB-18-24NI | 18"/24" Radiant Vented Burner Assembly IPI w/remote N.G. 50,000 BTUs | HTI 3 | \$ 1,479 | Y | Y | 14 | Y | Y | |
| RB-18-24PI | 18"/24" Radiant Vented Burner Assembly IPI w/remote L.P. 50,000 BTUs | HTI 3 | \$ 1,479 | Y | Y | 14 | Y | Y | |

Radiant Burner 30"

| | | | | | | | | | |
|---------|--|-------|----------|---|----|----|----|---|--|
| RB-30NI | 30" Radiant Vented Burner Assembly IPI w/remote N.G. 65,000 BTUs | HTI 3 | \$ 1,569 | Y | Y | 14 | Y | Y | |
| RB-30PI | 30" Radiant Vented Burner Assembly IPI w/remote L.P. 65,000 BTUs | HTI 3 | \$ 1,569 | Y | 14 | 14 | 14 | Y | |



Radiant Burner 18/24"



Radiant Burner 30"

Brick Panels

Herringbone Refractory Extension

| | | | | | | | | | |
|---------|--|-------|--------|---|----|----|----|---|--|
| MMHBX-B | Firebrick Yellow Herringbone brick refractory extensions | HTI 1 | \$ 179 | 8 | 21 | 21 | 21 | N | |
|---------|--|-------|--------|---|----|----|----|---|--|

Traditional Refractory Extension

| | | | | | | | | | |
|---------|--|-------|--------|---|----|----|----|---|--|
| MMTBX-B | Firebrick Yellow Traditional brick refractory extensions | HTI 1 | \$ 179 | 8 | 21 | 21 | 21 | Y | |
|---------|--|-------|--------|---|----|----|----|---|--|

Mortar

Refractory Mortar

| | | | | | | | | | |
|---------|---|-------|-------|---|---|---|---|---|--|
| MMMORTR | 10 lbs. Mortar (TRAD: 1 required, HERR: 2 required) | HTI 1 | \$ 99 | Y | Y | Y | Y | N | |
|---------|---|-------|-------|---|---|---|---|---|--|

Options & Accessories

Options & Accessories

| | | | | | | | | | |
|--------|--|-------|----|-----|---|----|----|----|---|
| AMMHBX | Natural Gray Herringbone brick refractory extensions | HTI 1 | \$ | 159 | 8 | 21 | 14 | 14 | Y |
| AMMTBX | Natural Gray Traditional brick refractory extensions | HTI 1 | \$ | 159 | 8 | 21 | 14 | 14 | Y |

Floor Protector (HP)

Micore Hearth Extension - Hearth Extension

| | | | | | | | | | |
|------|---|-------|----|-----|---|---|---|---|---|
| HX4M | Hearth extension for all size models (70"x 20"x 1/2") - pack of 5 | HTI 1 | \$ | 429 | Y | Y | Y | Y | N |
|------|---|-------|----|-----|---|---|---|---|---|

Venting

Insulated Flex Duct - Chimney Air Kits/Flex Duct

| | | | | | | | | | |
|-----|--|-------|----|-----|---|---|---|---|---|
| ID6 | 6" (152mm) insulated flex duct for use with outside air kit - includes two 42" (1065mm) sections | HTI 1 | \$ | 100 | Y | Y | Y | Y | Y |
|-----|--|-------|----|-----|---|---|---|---|---|

Uninsulated Flex Duct - Chimney Air Kits/Flex Duct

| | | | | | | | | | |
|-----|--|-------|----|----|---|----|----|----|---|
| UD6 | 6" (152mm) uninsulated flex duct for use with outside air kit - includes two 42" (1065mm) sections | HTI 1 | \$ | 71 | Y | 14 | 14 | 14 | Y |
|-----|--|-------|----|----|---|----|----|----|---|

SL400 Series Pipe - Term Kits & Acc - Sng Pk - Chimney Air Kits/Flex Duct

| | | | | | | | | | |
|-------|---|-------|----|-----|---|---|----|----|---|
| CAK5A | Chimney air kit for SL1100 and SL400 series pipe (required in Canada) | HTI 1 | \$ | 142 | Y | Y | 14 | 14 | Y |
|-------|---|-------|----|-----|---|---|----|----|---|

Service Parts

Service Parts

| | | | | | | | | | |
|-------------|--|-------|----|-----|----|----|----|----|---|
| SRV4059-693 | 36" Firebrick Yellow Hearth Refractory | HTI 1 | \$ | 357 | 14 | 21 | 14 | 14 | N |
|-------------|--|-------|----|-----|----|----|----|----|---|

Venting Notes

Requires SL1100 series chimney. CAK5A is optional air kit. See Venting section.

Model not approved for use in Canada

Rutherford 42

Includes:

- 42" x 38" opening
- Radiant heat
- Andirons
- Outside air standard
- UL listed
- Dual gas knockouts
- Steel grate
- Transition collar
- Safety firescreen
- Attic insulation shield



Special Considerations:

- When ordering Firebrick Yellow molded brick panels, SRV4059-695 is recommended for matching hearth

Required to Complete - Sold Separately: • Molded brick panel

| | | Disc. | MSRP | 004 | 010 | 014 | 016 | EXP |
|-----------------|--|-------|----------|-----|-----|-----|-----|-----|
| | | Code | USD | IA | PA | CA | NC | |
| RUTHERFORD-42-B | Rutherford 42 Wood Fireplace 42" radiant heat unit with Natural Gray Hearth Refractory | HNG 1 | \$ 3,839 | Y | Y | Y | 14 | N |

Refractory (Required to Complete)

Herringbone

| | | | | | | | | |
|----------|--|-------|----------|---|----|----|----|---|
| MMHB42-B | Firebrick Yellow Molded brick panels - herringbone | HTI 1 | \$ 1,539 | Y | 14 | 21 | 14 | N |
|----------|--|-------|----------|---|----|----|----|---|

Refractory

| | | | | | | | | |
|---------|--|-------|----------|---|---|---|---|---|
| AMMTB42 | Natural Gray Molded brick panels - traditional | HTI 1 | \$ 1,159 | Y | Y | Y | Y | N |
| AMMHB42 | Natural Gray Molded brick panels - herringbone | HTI 1 | \$ 1,539 | Y | Y | Y | Y | N |

Traditional

| | | | | | | | | |
|----------|--|-------|----------|---|----|----|----|---|
| MMTB42-B | Firebrick Yellow Molded brick panels - traditional | HTI 1 | \$ 1,159 | 8 | 14 | 21 | 14 | N |
|----------|--|-------|----------|---|----|----|----|---|

Glass Doors - Operable

Glass Bi-Fold Door

| | | | | | | | | |
|-----------|----------------------------|-------|----------|---|----|----|----|---|
| DFG4042BK | Glass bi-fold door - Black | HTI 1 | \$ 2,079 | 8 | 14 | 28 | 14 | N |
|-----------|----------------------------|-------|----------|---|----|----|----|---|



Glass Bi-Fold Door

Gas Logs - Log Set Option

Fireside Grand Oak Gas Log Sets

| | | | | | | | | |
|-----------------|---|-------|----------|----|----|----|----|---|
| GO324-IPI-NG-HK | 24" IPI Grand Oak NG Burner/Hearth Kit - 3 Tier | HTI 3 | \$ 1,499 | Y | 14 | 14 | 14 | N |
| GO324-IPI-LP-HK | 24" IPI Grand Oak LP Burner/Hearth Kit - 3 Tier | HTI 3 | \$ 1,499 | 21 | 21 | 21 | 21 | Y |

Grand Oak Logs 324

| | | | | | | | | |
|-------|---------------------------------------|-------|--------|----|----|----|---|---|
| GO324 | 24" Grand Oak Log Set - 11pcs, 3 Tier | HTI 3 | \$ 619 | 21 | 14 | 14 | Y | N |
|-------|---------------------------------------|-------|--------|----|----|----|---|---|



Fireside Grand Oak Gas Log Sets

| Brick Panels | | | | | | | | | | |
|---|--|-------|----|-----|---|----|----|----|----|---|
| Herringbone Refractory Extension | | | | | | | | | | |
| MMHBX-B | Firebrick Yellow Herringbone brick refractory extensions | HTI 1 | \$ | 179 | 8 | 21 | 21 | 21 | 21 | N |
| Traditional Refractory Extension | | | | | | | | | | |
| MMTBX-B | Firebrick Yellow Traditional brick refractory extensions | HTI 1 | \$ | 179 | 8 | 21 | 21 | 21 | 21 | Y |
| Mortar | | | | | | | | | | |
| Refractory Mortar | | | | | | | | | | |
| MMMORTR | 10 lbs. Mortar (TRAD: 1 required, HERR: 2 required) | HTI 1 | \$ | 99 | Y | Y | Y | Y | Y | N |
| Options & Accessories | | | | | | | | | | |
| Options & Accessories | | | | | | | | | | |
| AMMHBX | Natural Gray Herringbone brick refractory extensions | HTI 1 | \$ | 159 | 8 | 21 | 14 | 14 | 14 | Y |
| AMMTBX | Natural Gray Traditional brick refractory extensions | HTI 1 | \$ | 159 | 8 | 21 | 14 | 14 | 14 | Y |
| Floor Protector (HP) | | | | | | | | | | |
| Micore Hearth Extension - Hearth Extension | | | | | | | | | | |
| HX4M | Hearth extension for all size models (70"x 20"x 1/2") - pack of 5 | HTI 1 | \$ | 429 | Y | Y | Y | Y | Y | N |
| Venting | | | | | | | | | | |
| Insulated Flex Duct - Chimney Air Kits/Flex Duct | | | | | | | | | | |
| ID6 | 6" (152mm) insulated flex duct for use with outside air kit - includes two 42" (1065mm) sections | HTI 1 | \$ | 100 | Y | Y | Y | Y | Y | Y |
| Uninsulated Flex Duct - Chimney Air Kits/Flex Duct | | | | | | | | | | |
| UD6 | 6" (152mm) uninsulated flex duct for use with outside air kit - includes two 42" (1065mm) sections | HTI 1 | \$ | 71 | Y | 14 | 14 | 14 | 14 | Y |
| SL1100 Wood Pipe - Single Pack - Chimney Air Kits/Flex Duct Dimensions: 11" Inner / 13" Outer | | | | | | | | | | |
| CAK8A | Chimney air kit (For use with BIR42 and RUTHERFORD-42, ODCASTLEWD-42) | HTI 1 | \$ | 153 | Y | Y | 14 | 14 | 14 | Y |
| Service Parts | | | | | | | | | | |
| Service Parts | | | | | | | | | | |
| SRV4059-695 | 42" Firebrick Yellow Hearth Refractory | HTI 1 | \$ | 408 | 8 | 14 | 14 | 14 | 14 | N |
| Venting Notes | | | | | | | | | | |
| Requires SL1100 series chimney. CAK8A is optional air kit. See Venting section. | | | | | | | | | | |
| Model not approved for use in Canada | | | | | | | | | | |

Rutherford 50

Includes:

- 50" x 38" opening
- Radiant heat
- Outside air standard
- Andirons
- Dual gas knockouts
- Steel grate
- Safety firescreen
- UL listed



Special Considerations:

- When ordering Firebrick Yellow molded brick panels, SRV4059-697 is recommended for matching hearth

Required to Complete - Sold Separately:

- Molded brick panel
- See Venting notes
- Advanced Install Product training required before product ships

| | | Disc. | MSRP | 004 | 010 | 014 | 016 | EXP |
|-----------------|--|-------|----------|-----|-----|-----|-----|-----|
| | | Code | USD | IA | PA | CA | NC | |
| RUTHERFORD-50-B | Rutherford 50 Wood Fireplace 50" radiant heat unit with Natural Gray Hearth Refractory | HNG 1 | \$ 4,599 | Y | 14 | 14 | 14 | N |

Refractory (Required to Complete)

Herringbone

| | | | | | | | | |
|----------|--|-------|----------|---|----|----|----|---|
| MMHB50-B | Firebrick Yellow Molded brick panels - herringbone | HTI 1 | \$ 1,949 | Y | 14 | 14 | 14 | N |
|----------|--|-------|----------|---|----|----|----|---|

Refractory

| | | | | | | | | |
|---------|--|-------|----------|---|----|----|----|---|
| AMMTB50 | Natural Gray Molded brick panels - Traditional | HTI 1 | \$ 1,579 | 8 | 14 | 14 | 14 | N |
| AMMHB50 | Natural Gray Molded brick panels - Herringbone | HTI 1 | \$ 1,949 | Y | 14 | 14 | Y | N |

Traditional

| | | | | | | | | |
|----------|--|-------|----------|---|----|----|----|---|
| MMTB50-B | Firebrick Yellow Molded brick panels - traditional | HTI 1 | \$ 1,579 | 8 | 21 | 14 | 14 | N |
|----------|--|-------|----------|---|----|----|----|---|

Glass Doors - Operable

Glass Bi-Fold Door

| | | | | | | | | |
|-----------|----------------------------|-------|----------|---|----|----|----|---|
| DFG4050BK | Glass bi-fold door - Black | HTI 1 | \$ 2,199 | 8 | 21 | 14 | 14 | N |
|-----------|----------------------------|-------|----------|---|----|----|----|---|



Glass Bi-Fold Door

Gas Logs - Log Set Option

Fireside Grand Oak Gas Log Sets

| | | | | | | | | |
|-----------------|---|-------|----------|---|----|----|----|---|
| GO330-IPI-NG-HK | 30" IPI Grand Oak NG Burner/Hearth Kit - 3 Tier | HTI 3 | \$ 1,549 | Y | 21 | 21 | 14 | N |
| GO330-IPI-LP-HK | 30" IPI Grand Oak LP Burner/Hearth Kit - 3 Tier | HTI 3 | \$ 1,549 | Y | 21 | 14 | 14 | N |

Grand Oak Logs 330

| | | | | | | | | |
|-------|---------------------------------------|-------|--------|---|----|----|----|---|
| GO330 | 30" Grand Oak Log Set - 12pcs, 3 Tier | HTI 3 | \$ 689 | Y | 21 | 14 | 14 | N |
|-------|---------------------------------------|-------|--------|---|----|----|----|---|



Fireside Grand Oak Gas Log
Sets

| Brick Panels | | | | | | | | | | |
|---|--|-------|----|-----|---|----|----|----|----|---|
| Herringbone Refractory Extension | | | | | | | | | | |
| MMHBX-B | Firebrick Yellow Herringbone brick refractory extensions | HTI 1 | \$ | 179 | 8 | 21 | 21 | 21 | 21 | N |
| Traditional Refractory Extension | | | | | | | | | | |
| MMTBX-B | Firebrick Yellow Traditional brick refractory extensions | HTI 1 | \$ | 179 | 8 | 21 | 21 | 21 | 21 | Y |
| Mortar | | | | | | | | | | |
| Refractory Mortar | | | | | | | | | | |
| MMMORTR | 10 lbs. Mortar (TRAD: 1 required, HERR: 2 required) | HTI 1 | \$ | 99 | Y | Y | Y | Y | Y | N |
| Options & Accessories | | | | | | | | | | |
| Options & Accessories | | | | | | | | | | |
| AMMTBX | Natural Gray Traditional brick refractory extensions | HTI 1 | \$ | 159 | 8 | 21 | 14 | 14 | 14 | Y |
| AMMHBX | Natural Gray Herringbone brick refractory extensions | HTI 1 | \$ | 159 | 8 | 21 | 14 | 14 | 14 | Y |
| Floor Protector (HP) | | | | | | | | | | |
| Micore Hearth Extension - Hearth Extension | | | | | | | | | | |
| HX4M | Hearth extension for all size models (70"x 20"x 1/2") - pack of 5 | HTI 1 | \$ | 429 | Y | Y | Y | Y | Y | N |
| Venting | | | | | | | | | | |
| Insulated Flex Duct - Chimney Air Kits/Flex Duct | | | | | | | | | | |
| ID6 | 6" (152mm) insulated flex duct for use with outside air kit - includes two 42" (1065mm) sections | HTI 1 | \$ | 100 | Y | Y | Y | Y | Y | Y |
| Uninsulated Flex Duct - Chimney Air Kits/Flex Duct | | | | | | | | | | |
| UD6 | 6" (152mm) uninsulated flex duct for use with outside air kit - includes two 42" (1065mm) sections | HTI 1 | \$ | 71 | Y | 14 | 14 | 14 | 14 | Y |
| Service Parts | | | | | | | | | | |
| Service Parts | | | | | | | | | | |
| SRV4059-697 | 50" Firebrick Yellow Hearth Refractory | HTI 1 | \$ | 459 | 8 | 21 | 14 | 14 | 14 | N |
| Venting Notes | | | | | | | | | | |
| Requires 14" Dura-Vent DuraChimney II. See Venting Section. | | | | | | | | | | |
| Must order Attic Insulation Shield (14DCA-IS), Roof Radiation Shields (14DCA-RRS), Chase Top Collar (14DCA-CTC). See Venting Section. | | | | | | | | | | |
| Model not approved for use in Canada | | | | | | | | | | |

Heat & Glo

Insert - Gas

Stocked Item/Lead Time
 004=Mt. Pleasant RDC
 010=Kutztown RDC
 014=Sacramento RDC
 016=Charlotte RDC
 EXP=Factory Expedite Program

Page printed 3/31/2025, 8:22:26 AM CDT
 Current pricing updated 03/30/2025
 * Please Contact Who You Purchase This Through for MSRP Pricing

Prices in USD
 Non-stock and custom product cannot be cancelled.
 Customer is responsible for freight for orders made outside of assigned RDC facility.

Cosmo Insert 30"

- Includes:
- 19,600 - 28,000 BTU/Hour Input (NG)
 - 16,100 - 23,000 BTU/Hour Input (LP)
 - IntelliFire Touch Ignition System
 - Fluted Black Glass Liner
 - RC400 Remote Control
 - GFK-160A Variable Fan
 - Ceramic Glass
 - Battery Back Up
 - Electrical Cord - 10' 3" Left, X 7' 6" Right
 - Gas Flex Connector



Special Considerations:
 • LP requires conversion, order LPK-MI-IFT

Required to Complete - Sold Separately:
 • Front
 • Media
 • Surround

| | | Disc. Code | MSRP USD | 004 IA | 010 PA | 014 CA | 016 NC | EXP |
|---------------|--|------------|----------|--------|--------|--------|--------|-----|
| COSMO-I30-IFT | Cosmo medium 30" contemporary direct vent gas insert with intellifire touch ignition system (NG) | HNG 3 | \$ 3,169 | Y | 14 | Y | Y | N |

Fronts - Non-Operable (Required to Complete)

Firescreen

| | | | | | | | | |
|------------|--|-------|--------|----|---|---|----|---|
| FS-MI30-BK | Firescreen 30" screen front - Black | HNG 3 | \$ 419 | Y | Y | Y | Y | Y |
| FS-MI30-NB | Firescreen 30" screen front - New Bronze | HNG 3 | \$ 439 | Y | Y | Y | 21 | Y |
| FS-MI30-GM | Firescreen 30" screen front - Gun Metal | HNG 3 | \$ 439 | 14 | Y | Y | 14 | Y |

Halston Arch

| | | | | | | | | |
|--------------|--|-------|--------|---|----|----|----|---|
| HARC-MI30-BK | Halston arched 30" screen front - Black | HNG 3 | \$ 779 | Y | Y | Y | 21 | Y |
| HARC-MI30-NB | Halston arched 30" screen front - New Bronze | HNG 3 | \$ 819 | Y | Y | Y | 14 | Y |
| HARC-MI30-GM | Halston arched 30" screen front - Gun Metal | HNG 3 | \$ 819 | Y | 14 | 14 | 14 | Y |

Inside Fit

| | | | | | | | | |
|-------------|-------------------------------------|-------|--------|---|---|---|----|---|
| INFIT-30-BK | Inside fit 30" screen front - Black | HTI 3 | \$ 369 | Y | Y | Y | 14 | Y |
|-------------|-------------------------------------|-------|--------|---|---|---|----|---|

Iron Age

| | | | | | | | | |
|------------|--|-------|--------|----|----|----|----|---|
| IA-MI30-BK | Iron Age 30" screen front - Black | HNG 3 | \$ 619 | Y | Y | Y | 14 | Y |
| IA-MI25-GM | Iron Age 25" screen front - Gun Metal | HNG 3 | \$ 629 | 14 | 14 | 14 | 14 | Y |
| IA-MI30-NB | Iron Age 30" screen front - New Bronze | HNG 3 | \$ 669 | Y | 14 | Y | 14 | Y |
| IA-MI30-GM | Iron Age 30" screen front - Gun Metal | HNG 3 | \$ 669 | 14 | Y | 14 | 14 | Y |



Firescreen

Halston Arch

Inside Fit

Iron Age

Media (Required to Complete)

Glass Media

| | | | | | | | | |
|-----------------|--|-------|--------|----|----|----|----|---|
| MEDIA-CLEAR-MI | Glass media - Clear | HNG 3 | \$ 119 | Y | Y | Y | Y | Y |
| MEDIA-FOG-MI | Glass media - Fog (requires hi-temp black spray paint to finish) | HNG 3 | \$ 119 | 14 | 21 | 14 | 14 | Y |
| MEDIA-RED-MI | Glass media - Red | HNG 3 | \$ 119 | 14 | 21 | 14 | 14 | Y |
| MEDIA-COBALT-MI | Glass media - Cobalt | HNG 3 | \$ 119 | 14 | 21 | 21 | 14 | Y |
| MEDIA-AMBER-MI | Glass media - Amber | HNG 3 | \$ 119 | 14 | 21 | 14 | 14 | Y |
| MEDIA-EBONY-MI | Glass media - Ebony | HNG 3 | \$ 119 | Y | Y | Y | 14 | Y |

Driftwood Logs

| | | | | | | | | |
|-------------|------------------------------------|-------|--------|---|---|---|----|---|
| DWLG-MI-HNG | Driftwood Log set (requires media) | HNG 3 | \$ 269 | Y | Y | Y | 14 | Y |
|-------------|------------------------------------|-------|--------|---|---|---|----|---|

MEDIA

| | | | | | | | | |
|-----------|---------------------------------------|-------|--------|---|---|---|----|---|
| STONES-MI | River Rock Stone Set (requires media) | HNG 3 | \$ 110 | Y | Y | Y | 14 | Y |
|-----------|---------------------------------------|-------|--------|---|---|---|----|---|

Metal Surrounds (Required to Complete)

Surrounds - Small

| | | | | | | | | |
|--------------|---|-------|--------|----|----|----|----|---|
| MI30-4027-BK | Small 30" surround 40" x 27" - Black | HTI 3 | \$ 379 | Y | Y | Y | Y | Y |
| MI30-4027-GM | Small 30" surround 40" x 27" - Gun Metal | HNG 3 | \$ 419 | 14 | 14 | 14 | 14 | Y |
| MI30-4027-NB | Small 30" surround 40" x 27" - New Bronze | HTI 3 | \$ 419 | Y | 14 | Y | 21 | Y |

Surrounds - Medium

| | | | | | | | | |
|---------------|---|-------|--------|----|---|----|----|---|
| MI30-4230-BK | Medium 30" surround 42" x 30" - Black | HTI 3 | \$ 409 | Y | Y | Y | Y | Y |
| MI30-4230D-BK | Medium 30" surround 42" x 30" x 2" deep - Black | HTI 3 | \$ 409 | Y | Y | Y | 14 | Y |
| MI30-4230-NB | Medium 30" surround 42" x 30" - New Bronze | HTI 3 | \$ 439 | Y | Y | Y | 14 | Y |
| MI30-4230-GM | Medium 30" surround 42" x 30" - Gun Metal | HNG 3 | \$ 439 | 14 | Y | 14 | 14 | Y |

Surrounds - Large

| | | | | | | | | |
|--------------|---|-------|--------|----|----|----|----|---|
| MI30-4432-BK | Large 30" surround 44" x 32" - Black | HTI 3 | \$ 429 | Y | Y | Y | 14 | Y |
| MI30-4432-NB | Large 30" surround 44" x 32" - New Bronze | HTI 3 | \$ 469 | Y | 14 | Y | 14 | Y |
| MI30-4432-GM | Large 30" surround 44" x 32" - Gun Metal | HNG 3 | \$ 469 | 14 | 14 | 14 | 14 | Y |

Custom Surround

| | | | | | | | | |
|----------------|---|-------|--------|----|----|----|----|---|
| MI-USBC-RELO | Relocation kit for USB-C and reset switch from surround to under the front. For use when using inside fit or onsite surround. | HTI 3 | \$ 37 | Y | Y | Y | 14 | Y |
| MI30-5040CS-BK | On site 30" customizable surround - 50" w x 40" h (comes 4 sided with a 6" bottom, can be trimmed to make 3 sided) | HTI 3 | \$ 489 | Y | Y | Y | Y | N |
| CUST-SRND-MI | Custom surround metal inserts (see custom surround order form for details) | HTI 3 | \$ 859 | 14 | 14 | 21 | 14 | Y |

Venting (Required to Complete)

Gas Insert Venting - 30/30 Termination Kits

| | | | | | | | | |
|----------------|--|-------|--------|---|---|----|----|---|
| LINK-DV4-30B | Direct vent insert kit - one 4 - liner, one 30 - liner, plus term cap components | HTI 1 | \$ 549 | Y | Y | Y | Y | Y |
| LINKSQB-DV4-30 | Direct vent insert kit - one 4 - liner, one 30 - liner, plus black term cap components | HTI 1 | \$ 649 | Y | Y | 14 | 14 | Y |
| LINK-DV30B | Direct vent insert kit - two 30 - liners, plus term cap components | HTI 1 | \$ 649 | Y | Y | Y | Y | Y |
| LINKSQB-DV30 | Direct vent insert kit - two 30 - liners, plus black term cap components | HTI 1 | \$ 729 | Y | Y | Y | 14 | Y |
| LINKSQC-DV30 | Direct vent insert kit - two 30" liners, plus faux copper term cap components | HTI 1 | \$ 789 | Y | Y | Y | 14 | Y |

Conversion Kit

Conversion Kit

| | | | | | | | | |
|------------|---|-------|------|--|---|---|---|---|
| LPK-MI-IFT | LP conversion kit for metal insert with IntelliFire Touch | HTI 3 | \$ 0 | | Y | Y | Y | Y |
|------------|---|-------|------|--|---|---|---|---|

Liner Kit

Glass Liner

| | | | | | | | | |
|----------------|---|-------|--------|----|---|---|----|---|
| LINER-MOD30-BK | Reflective Black Glass Liner for 30" contemporary units | HTI 3 | \$ 549 | 14 | Y | Y | 14 | Y |
|----------------|---|-------|--------|----|---|---|----|---|

Control, remotes, wall switches

Battery Back Up

| | | | | | | | | |
|-------------|--|-------|--------|---|----|---|----|---|
| BATTERY-WSK | Battery backup wall switch kit for units with IFT control systems. Includes: On/Off Wall Switch, USB-C Port, Battery Backup, Cover Plate, 12' Wire Harness | HTI 1 | \$ 189 | Y | 14 | Y | 14 | Y |
|-------------|--|-------|--------|---|----|---|----|---|

IntelliFire app

| | | | | | | | | |
|---------|---|-------|--------|---|---|---|---|---|
| IFT-WFM | IntelliFire Wi-Fi Module that works with the IntelliFire iOS and Android app. Use to control all the features of your fireplace via a smart device. An RC400, RC450 or RC150 is required for thermostat control | HTI 1 | \$ 229 | Y | Y | Y | Y | Y |
|---------|---|-------|--------|---|---|---|---|---|

Touch Screen Remote

| | | | | | | | | |
|-----------|---|-------|--------|---|---|---|---|---|
| IFT-RC400 | IntelliFire Touch black remote control, docking station and auxiliary control module (on/off, flame height, thermostat mode, fan control, child lock, cold climate, timer mode, hot indicator, lights, on-screen maintenance and troubleshooting notifications) | HTI 1 | \$ 389 | Y | Y | Y | Y | Y |
|-----------|---|-------|--------|---|---|---|---|---|

Wall Switch

| | | | | | | | | |
|---------------|---|-------|--------|---|---|---|---|---|
| IFT-RC150-HNG | IntelliFire Touch white wireless wall switch (on/off, cold climate, battery strength indicator) | HNG 1 | \$ 121 | Y | Y | Y | Y | Y |
|---------------|---|-------|--------|---|---|---|---|---|



Battery Back Up



IntelliFire app

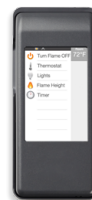

Touch Screen Remote



Wall Switch

Venting Notes

Requires: LINK-DV30B, LINKSQB-DV30, LINKSQC-DV30, LINK-DV4-30B, LINKSQB-DV-30 or LINKSQC-DV4-30 flex liner kit. Refer to Venting section.

Cosmo Insert 35"

Includes:

- 21,000 - 30,000 BTU/Hour Input (NG)
- 19,600 - 28,000 BTU/Hour Input (LP)
- IntelliFire Touch Ignition System
- Fluted Black Glass Liner
- RC400 Remote Control
- GFK-160A Variable Fan
- Ceramic Glass
- Battery Back Up
- Electrical Cord - 10' Left, X 7" Right
- Gas Flex Connector



Special Considerations:

- LP requires conversion, order LPK-MI-IFT

Required to Complete - Sold Separately:

- Front
- Media
- Surround

| | | Disc. Code | MSRP USD | 004 IA | 010 PA | 014 CA | 016 NC | EXP |
|---------------|---|------------|----------|--------|--------|--------|--------|-----|
| COSMO-I35-IFT | Cosmo large 35" contemporary direct vent gas insert with intellifire touch ignition system (NG) | HNG 3 | \$ 3,539 | 14 | 14 | Y | Y | N |

Fronts - Non-Operable (Required to Complete)

Firescreen

| | | | | | | | | |
|------------|--|-------|--------|----|----|----|----|---|
| FS-MI35-BK | Firescreen 35" screen front - Black | HNG 3 | \$ 439 | Y | Y | Y | Y | Y |
| FS-MI35-NB | Firescreen 35" screen front - New Bronze | HNG 3 | \$ 469 | Y | 14 | Y | 14 | Y |
| FS-MI35-GM | Firescreen 35" screen front - Gun Metal | HNG 3 | \$ 469 | 14 | 14 | 14 | 14 | Y |

Halston Arch

| | | | | | | | | |
|--------------|--|-------|--------|----|----|----|----|---|
| HARC-MI35-BK | Halston arched 35"screen front - Black | HNG 3 | \$ 819 | Y | Y | Y | 14 | Y |
| HARC-MI35-NB | Halston arched 35" screen front - New Bronze | HNG 3 | \$ 859 | Y | 14 | Y | 14 | Y |
| HARC-MI35-GM | Halston arched 35" screen front - Gun Metal | HNG 3 | \$ 859 | 14 | 14 | 14 | 14 | Y |

Inside Fit

| | | | | | | | | |
|-------------|-------------------------------------|-------|--------|---|---|----|----|---|
| INFIT-35-BK | Inside fit 35" screen front - Black | HTI 3 | \$ 399 | Y | Y | 14 | 14 | Y |
|-------------|-------------------------------------|-------|--------|---|---|----|----|---|

Iron Age

| | | | | | | | | |
|------------|--|-------|--------|----|----|----|----|---|
| IA-MI35-BK | Iron Age 35" screen front - Black | HNG 3 | \$ 669 | 14 | Y | 14 | 14 | Y |
| IA-MI35-NB | Iron Age 35" screen front - New Bronze | HNG 3 | \$ 709 | Y | 14 | 14 | 14 | Y |
| IA-MI35-GM | Iron Age 35" screen front - Gun Metal | HNG 3 | \$ 709 | 14 | 14 | 14 | 14 | Y |



Firescreen



Halston Arch



Inside Fit



Iron Age

| Media (Required to Complete) | | | | | | | | | | |
|---|---|-------|--------|----|----|----|----|---|--|--|
| Glass Media | | | | | | | | | | |
| MEDIA-FOG-MI | Glass media - Fog (requires hi-temp black spray paint to finish) | HNG 3 | \$ 119 | 14 | 21 | 14 | 14 | Y | | |
| MEDIA-COBALT-MI | Glass media - Cobalt | HNG 3 | \$ 119 | 14 | 21 | 21 | 14 | Y | | |
| MEDIA-AMBER-MI | Glass media - Amber | HNG 3 | \$ 119 | 14 | 21 | 14 | 14 | Y | | |
| MEDIA-CLEAR-MI | Glass media - Clear | HNG 3 | \$ 119 | Y | Y | Y | Y | Y | | |
| MEDIA-EBONY-MI | Glass media - Ebony | HNG 3 | \$ 119 | Y | Y | Y | 14 | Y | | |
| MEDIA-RED-MI | Glass media - Red | HNG 3 | \$ 119 | 14 | 21 | 14 | 14 | Y | | |
| Driftwood Logs | | | | | | | | | | |
| DWLG-MI-HNG | Driftwood Log set (requires media) | HNG 3 | \$ 269 | Y | Y | Y | 14 | Y | | |
| MEDIA | | | | | | | | | | |
| STONES-MI | River Rock Stone Set (requires media) | HNG 3 | \$ 110 | Y | Y | Y | 14 | Y | | |
| Metal Surrounds (Required to Complete) | | | | | | | | | | |
| Surrounds - Small | | | | | | | | | | |
| MI35-4229-BK | Small 35" surround 42" x 29" - Black | HTI 3 | \$ 409 | Y | Y | Y | Y | Y | | |
| MI35-4229-NB | Small 35" surround 42" x 29" - New Bronze | HTI 3 | \$ 439 | Y | 14 | Y | 14 | Y | | |
| MI35-4229-GM | Small 35" surround 42" x 29" - Gun Metal | HNG 3 | \$ 439 | 14 | 14 | 14 | 14 | Y | | |
| Surrounds - Medium | | | | | | | | | | |
| MI35-4432D-BK | Medium 35" surround 44" x 32" x 2" deep - Black | HTI 3 | \$ 429 | 14 | 14 | Y | 14 | Y | | |
| MI35-4432-BK | Medium 35" surround 44" x 32" - Black | HTI 3 | \$ 429 | Y | Y | Y | Y | Y | | |
| MI35-4432-NB | Medium 35" surround 44" x 32" - New Bronze | HTI 3 | \$ 469 | 14 | 14 | Y | 14 | Y | | |
| MI35-4432-GM | Medium 35" surround 44" x 32" - Gun Metal | HNG 3 | \$ 469 | 14 | 14 | 14 | 14 | Y | | |
| Surrounds - Large | | | | | | | | | | |
| MI35-4832-BK | Large 35" surround 48" x 32" - Black | HTI 3 | \$ 459 | Y | Y | Y | 14 | Y | | |
| MI35-4832-GM | Large 35" surround 48" x 32" - Gun Metal | HNG 3 | \$ 489 | 14 | 14 | 14 | 14 | Y | | |
| MI35-4832-NB | Large 35" surround 48" x 32" - New Bronze | HTI 3 | \$ 489 | 14 | 14 | 14 | 14 | Y | | |
| Custom Surround | | | | | | | | | | |
| MI-USBC-RELO | Relocation kit for USB-C and reset switch from surround to under the front. For use when using inside fit or onsite surround. | HTI 3 | \$ 37 | Y | Y | Y | 14 | Y | | |
| MI35-5040CS-BK | On site 35" customizable surround - 50" w x 40" h (comes 4 sided with a 5" bottom, can be trimmed to make 3 sided) | HTI 3 | \$ 509 | Y | Y | Y | Y | Y | | |
| CUST-SRND-MI | Custom surround metal inserts (see custom surround order form for details) | HTI 3 | \$ 859 | 14 | 14 | 21 | 14 | Y | | |
| Venting (Required to Complete) | | | | | | | | | | |
| Gas Insert Venting - 30/30 Termination Kits | | | | | | | | | | |
| LINK-DV4-30B | Direct vent insert kit - one 4 - liner, one 30 - liner, plus term cap components | HTI 1 | \$ 549 | Y | Y | Y | Y | Y | | |
| LINKSQB-DV4-30 | Direct vent insert kit - one 4 - liner, one 30 - liner, plus black term cap components | HTI 1 | \$ 649 | Y | Y | 14 | 14 | Y | | |
| LINK-DV30B | Direct vent insert kit - two 30 - liners, plus term cap components | HTI 1 | \$ 649 | Y | Y | Y | Y | Y | | |
| LINKSQB-DV30 | Direct vent insert kit - two 30 - liners, plus black term cap components | HTI 1 | \$ 729 | Y | Y | Y | 14 | Y | | |
| LINKSQC-DV30 | Direct vent insert kit - two 30" liners, plus faux copper term cap components | HTI 1 | \$ 789 | Y | Y | Y | 14 | Y | | |
| Conversion Kit | | | | | | | | | | |
| Conversion Kit | | | | | | | | | | |
| LPK-MI-IFT | LP conversion kit for metal insert with IntelliFire Touch | HTI 3 | \$ 0 | | Y | Y | Y | Y | | |

Liner Kit

Glass Liner

| | | | | | | | | |
|----------------|---|-------|--------|----|---|---|----|---|
| LINER-MOD35-BK | Reflective Black Glass Liner for 35" contemporary units | HTI 3 | \$ 679 | 14 | Y | Y | 14 | Y |
|----------------|---|-------|--------|----|---|---|----|---|

Control, remotes, wall switches

Battery Back Up

| | | | | | | | | |
|-------------|--|-------|--------|---|----|---|----|---|
| BATTERY-WSK | Battery backup wall switch kit for units with IFT control systems. Includes: On/Off Wall Switch, USB-C Port, Battery Backup, Cover Plate, 12' Wire Harness | HTI 1 | \$ 189 | Y | 14 | Y | 14 | Y |
|-------------|--|-------|--------|---|----|---|----|---|

IntelliFire app

| | | | | | | | | |
|---------|---|-------|--------|---|---|---|---|---|
| IFT-WFM | IntelliFire Wi-Fi Module that works with the IntelliFire iOS and Android app. Use to control all the features of your fireplace via a smart device. An RC400, RC450 or RC150 is required for thermostat control | HTI 1 | \$ 229 | Y | Y | Y | Y | Y |
|---------|---|-------|--------|---|---|---|---|---|

Touch Screen Remote

| | | | | | | | | |
|-----------|---|-------|--------|---|---|---|---|---|
| IFT-RC400 | IntelliFire Touch black remote control, docking station and auxiliary control module (on/off, flame height, thermostat mode, fan control, child lock, cold climate, timer mode, hot indicator, lights, on-screen maintenance and troubleshooting notifications) | HTI 1 | \$ 389 | Y | Y | Y | Y | Y |
|-----------|---|-------|--------|---|---|---|---|---|

Wall Switch

| | | | | | | | | |
|---------------|---|-------|--------|---|---|---|---|---|
| IFT-RC150-HNG | IntelliFire Touch white wireless wall switch (on/off, cold climate, battery strength indicator) | HNG 1 | \$ 121 | Y | Y | Y | Y | Y |
|---------------|---|-------|--------|---|---|---|---|---|



Battery Back Up



IntelliFire app

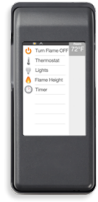

Touch Screen Remote



Wall Switch

Venting Notes

Requires: LINK-DV30B, LINKSQB-DV30, LINKSQC-DV30, LINK-DV4-30B, LINKSQB-DV-30 or LINKSQC-DV4-30 flex liner kit. Refer to Venting section.

Escape-30

Includes:

- 18,500 - 36,000 Btu/Hour Input (NG)
- Anti-reflective ceramic glass
- ClearVue™ Screen
- Gas flex connector
- Dual variable speed fan
- Illuminated glowing ember bed
- Patented FireBrick Technology
- Battery backup
- 6 ceramic fiber logs
- RC400 touchscreen remote
- IntelliFire™ Touch Ignition System



Required to Complete - Sold Separately: • Front and surround

| | | Disc. Code | MSRP USD | 004 IA | 010 PA | 014 CA | 016 NC | EXP |
|-----------------|---|------------|----------|--------|--------|--------|--------|-----|
| ESCAPE-30-IFT | 30" Direct Vent FireBrick Insert with IntelliFire Touch Ignition System, NG | HNG 3 | \$ 3,839 | Y | Y | Y | Y | N |
| ESCAPE-30LP-IFT | 30" Direct Vent FireBrick Insert with IntelliFire Touch Ignition System, LP | HNG 3 | \$ 3,909 | 14 | Y | Y | 14 | N |

Fronts - Non-Operable (Required to Complete)

Chateau Forge

| | | | | | | | | |
|-----------|---|-------|----------|---|---|---|----|---|
| CHAF-FB30 | Chateau Forge, hand-crafted, with forged bars and strips- Natural Iron finish | HNG 3 | \$ 2,099 | Y | Y | Y | 14 | Y |
|-----------|---|-------|----------|---|---|---|----|---|

Firescreen

| | | | | | | | | |
|------------|------------------------------|-------|--------|----|----|----|----|---|
| FS-FB30-BK | Firescreen Front, Black | HNG 3 | \$ 489 | Y | Y | Y | Y | Y |
| FS-FB30-NB | Firescreen Front, New Bronze | HNG 3 | \$ 549 | Y | 14 | Y | 14 | Y |
| FS-FB30-GM | Firescreen front - Gun Metal | HNG 3 | \$ 549 | 14 | 14 | 14 | 14 | Y |

Galleria

| | | | | | | | | |
|-------------|----------------------------|-------|----------|----|----|----|----|---|
| GAL-FB30-BK | Galleria Front, Black | HNG 3 | \$ 969 | Y | Y | Y | 21 | Y |
| GAL-FB30-GM | Galleria Front, Gun Metal | HNG 3 | \$ 1,019 | 14 | 14 | 14 | 14 | Y |
| GAL-FB30-NB | Galleria Front, New Bronze | HNG 3 | \$ 1,019 | Y | 14 | 14 | 14 | Y |

Halston

| | | | | | | | | |
|-------------|---------------------------|-------|--------|----|----|----|----|---|
| HAL-FB30-BK | Halston Front, Black | HNG 3 | \$ 839 | Y | Y | 14 | 14 | Y |
| HAL-FB30-NB | Halston Front, New Bronze | HNG 3 | \$ 889 | Y | 14 | 14 | 14 | Y |
| HAL-FB30-GM | Halston Front, Gun Metal | HNG 3 | \$ 889 | 14 | 14 | 14 | 14 | Y |

Iron Age

| | | | | | | | | |
|------------|----------------------------|-------|--------|----|----|----|----|---|
| IA-FB30-BK | Iron Age Front, Black | HNG 3 | \$ 669 | Y | Y | 14 | Y | Y |
| IA-FB30-NB | Iron Age Front, New Bronze | HNG 3 | \$ 709 | Y | 14 | Y | 14 | Y |
| IA-FB30-GM | Iron Age Front, Gun Metal | HNG 3 | \$ 709 | 14 | Y | 14 | 14 | Y |

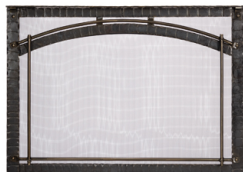

Chateau Forge



Firescreen



Galleria



Halston



Iron Age

Metal Surrounds (Required to Complete)**Surrounds - Small**

| | | | | | | | | |
|---------------|--|-------|--------|----|----|----|----|---|
| FBI30-4027-BK | Small surround, 40" x 27", classic black | HTI 3 | \$ 489 | Y | Y | Y | Y | Y |
| FBI30-4027-NB | Small surround, 40" x 27" - New Bronze | HTI 3 | \$ 539 | Y | 14 | Y | 14 | Y |
| FBI30-4027-GM | Small surround, 40" x 27" - Gun Metal | HNG 3 | \$ 539 | 14 | 14 | 14 | 14 | Y |

Surrounds - Medium

| | | | | | | | | |
|---------------|---|-------|--------|----|----|----|----|---|
| FBI30-4230-BK | Medium surround, 42" x 30", classic black | HTI 3 | \$ 509 | Y | Y | Y | Y | Y |
| FBI30-4230-GM | Medium surround, 42" x 30" - Gun Metal | HNG 3 | \$ 549 | 14 | 14 | 14 | 14 | Y |
| FBI30-4230-NB | Medium surround, 42" x 30" - New Bronze | HTI 3 | \$ 549 | Y | 14 | Y | 14 | Y |

Surrounds - Large

| | | | | | | | | |
|---------------|--|-------|--------|----|----|----|----|---|
| FBI30-4432-BK | Large surround, 44" x 32", classic black | HTI 3 | \$ 569 | Y | Y | Y | 14 | Y |
| FBI30-4432-NB | Large surround, 44" x 32" - New Bronze | HTI 3 | \$ 609 | 14 | 14 | 14 | 14 | Y |
| FBI30-4432-GM | Large surround, 44" x 32" - Gun Metal | HNG 3 | \$ 609 | 14 | 14 | 14 | 14 | Y |

Custom Surround

| | | | | | | | | |
|-------------|-----------------|-------|--------|----|----|----|----|---|
| CUST-2215-F | Custom surround | HTI 1 | \$ 989 | 14 | 14 | 21 | 14 | Y |
|-------------|-----------------|-------|--------|----|----|----|----|---|

Venting (Required to Complete)**Gas Insert Venting - 30/30 Termination Kits**

| | | | | | | | | |
|----------------|--|-------|--------|---|---|----|----|---|
| LINK-DV4-30B | Direct vent insert kit - one 4 - liner, one 30 - liner, plus term cap components | HTI 1 | \$ 549 | Y | Y | Y | Y | Y |
| LINKSQB-DV4-30 | Direct vent insert kit - one 4 - liner, one 30 - liner, plus black term cap components | HTI 1 | \$ 649 | Y | Y | 14 | 14 | Y |
| LINK-DV30B | Direct vent insert kit - two 30 - liners, plus term cap components | HTI 1 | \$ 649 | Y | Y | Y | Y | Y |
| LINKSQB-DV30 | Direct vent insert kit - two 30 - liners, plus black term cap components | HTI 1 | \$ 729 | Y | Y | Y | 14 | Y |
| LINKSQC-DV30 | Direct vent insert kit - two 30" liners, plus faux copper term cap components | HTI 1 | \$ 789 | Y | Y | Y | 14 | Y |

Gas Insert Venting - Components

| | | | | | | | | |
|--------------|---|-------|-------|---|---|----|----|---|
| LINK-ZC-ADPB | 14 1/2" round flashing adapter kit (for use with existing liner kits when using Class A pipe) | HTI 1 | \$ 90 | Y | Y | 14 | 14 | Y |
|--------------|---|-------|-------|---|---|----|----|---|

Control, remotes, wall switches**IntelliFire app**

| | | | | | | | | |
|---------|---|-------|--------|---|---|---|---|---|
| IFT-WFM | IntelliFire Wi-Fi Module that works with the IntelliFire iOS and Android app. Use to control all the features of your fireplace via a smart device. An RC400, RC450 or RC150 is required for thermostat control | HTI 1 | \$ 229 | Y | Y | Y | Y | Y |
|---------|---|-------|--------|---|---|---|---|---|

Touch Screen Remote

| | | | | | | | | |
|-----------|---|-------|--------|---|---|---|---|---|
| IFT-RC400 | IntelliFire Touch black remote control, docking station and auxiliary control module (on/off, flame height, thermostat mode, fan control, child lock, cold climate, timer mode, hot indicator, lights, on-screen maintenance and troubleshooting notifications) | HTI 1 | \$ 389 | Y | Y | Y | Y | Y |
|-----------|---|-------|--------|---|---|---|---|---|

Wall Switch

| | | | | | | | |
|---------------|---|--------------|---|---|---|---|---|
| IFT-RC150-HNG | IntelliFire Touch white wireless wall switch (on/off, cold climate, battery strength indicator) | HNG 1 \$ 121 | Y | Y | Y | Y | Y |
|---------------|---|--------------|---|---|---|---|---|



IntelliFire app

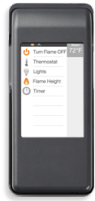

Touch Screen Remote



Wall Switch

Venting Notes

Requires: LINK-DV30B, LINKSQB-DV30, LINKSQC-DV30, LINK-DV4-30B, LINKSQB-DV4-30 or LINKSQC-DV4-30 flex liner kit. Refer to Venting section

Escape-35

Includes:

- 20,000 - 40,000 Btu/Hour Input (NG)
- Anti-reflective ceramic glass
- ClearVue™ Screen
- Gas flex connector
- Dual variable speed fan
- Illuminated glowing ember bed
- Patented FireBrick Technology
- Battery backup
- 6 ceramic fiber logs
- RC400 touchscreen remote
- IntelliFire™ Touch Ignition System



Required to Complete - Sold Separately: • Front and surround

| | | Disc. Code | MSRP USD | 004 IA | 010 PA | 014 CA | 016 NC | EXP |
|-----------------|---|------------|----------|--------|--------|--------|--------|-----|
| ESCAPE-35-IFT | 35" Direct Vent FireBrick Insert with IntelliFire Touch Ignition System, NG | HNG 3 | \$ 4,139 | Y | Y | Y | Y | N |
| ESCAPE-35LP-IFT | 35" Direct Vent FireBrick Insert with IntelliFire Touch Ignition System, LP | HNG 3 | \$ 4,209 | 14 | Y | Y | Y | N |

Fronts - Non-Operable (Required to Complete)

Chateau Forge

| | | | | | | | | |
|-----------|---|-------|----------|---|---|---|----|---|
| CHAF-FB35 | Chateau Forge, hand-crafted, with forged bars and strips- Natural Iron finish | HNG 3 | \$ 2,279 | Y | Y | Y | 14 | Y |
|-----------|---|-------|----------|---|---|---|----|---|

Firescreen

| | | | | | | | | |
|------------|------------------------------|-------|--------|----|----|----|----|---|
| FS-FB35-BK | Firescreen Front, Black | HNG 3 | \$ 499 | Y | Y | Y | Y | Y |
| FS-FB35-NB | Firescreen Front, New Bronze | HNG 3 | \$ 549 | Y | 14 | Y | 14 | Y |
| FS-FB35-GM | Firescreen front - Gun Metal | HNG 3 | \$ 549 | 14 | 14 | 14 | 14 | Y |

Galleria

| | | | | | | | | |
|-------------|----------------------------|-------|----------|----|----|----|----|---|
| GAL-FB35-BK | Galleria Front, Black | HNG 3 | \$ 1,159 | Y | Y | Y | 14 | Y |
| GAL-FB35-NB | Galleria Front, New Bronze | HNG 3 | \$ 1,209 | Y | 14 | 14 | 14 | Y |
| GAL-FB35-GM | Galleria Front, Gun Metal | HNG 3 | \$ 1,209 | 14 | 14 | 14 | 14 | Y |

Halston

| | | | | | | | | |
|-------------|---------------------------|-------|--------|----|----|----|----|---|
| HAL-FB35-BK | Halston Front, Black | HNG 3 | \$ 889 | Y | Y | 14 | 14 | Y |
| HAL-FB35-GM | Halston Front, Gun Metal | HNG 3 | \$ 939 | 14 | 14 | 14 | 14 | Y |
| HAL-FB35-NB | Halston Front, New Bronze | HNG 3 | \$ 939 | 14 | 14 | 14 | 14 | Y |

Iron Age

| | | | | | | | | |
|------------|----------------------------|-------|--------|----|----|----|----|---|
| IA-FB35-BK | Iron Age Front, Black | HNG 3 | \$ 709 | Y | Y | Y | Y | Y |
| IA-FB35-NB | Iron Age Front, New Bronze | HNG 3 | \$ 769 | Y | 14 | Y | 14 | Y |
| IA-FB35-GM | Iron Age Front, Gun Metal | HNG 3 | \$ 769 | 14 | 14 | 14 | 14 | Y |

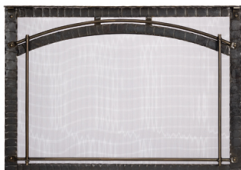

Chateau Forge



Firescreen



Galleria



Halston



Iron Age

Metal Surrounds (Required to Complete)**Surrounds - Small**

| | | | | | | | | |
|---------------|--|-------|--------|----|----|----|----|---|
| FBI35-4229-BK | Small surround, 42" x 29", classic black | HTI 3 | \$ 509 | Y | Y | Y | Y | Y |
| FBI35-4229-NB | Small surround, 42" x 29" - New Bronze | HTI 3 | \$ 549 | Y | 14 | Y | 14 | Y |
| FBI35-4229-GM | Small surround, 42" x 29" - Gun Metal | HNG 3 | \$ 549 | 14 | 14 | 14 | 14 | Y |

Surrounds - Medium

| | | | | | | | | |
|---------------|---|-------|--------|----|----|----|----|---|
| FBI35-4432-BK | Medium surround, 44" x 32", classic black | HTI 3 | \$ 549 | Y | Y | Y | Y | N |
| FBI35-4432-NB | Medium surround, 44" x 32" - New Bronze | HTI 3 | \$ 589 | Y | 14 | 14 | 14 | Y |
| FBI35-4432-GM | Medium surround, 44" x 32" - Gun Metal | HNG 3 | \$ 589 | 14 | 14 | 14 | 14 | Y |

Surrounds - Large

| | | | | | | | | |
|---------------|--|-------|--------|----|----|----|----|---|
| FBI35-4832-BK | Large surround, 48" x 32", classic black | HTI 3 | \$ 589 | Y | Y | Y | 14 | Y |
| FBI35-4832-NB | Large surround, 48" x 32" - New Bronze | HTI 3 | \$ 629 | 14 | 14 | 14 | 14 | Y |
| FBI35-4832-GM | Large surround, 48" x 32" - Gun Metal | HNG 3 | \$ 629 | 14 | 14 | 14 | 14 | Y |

Custom Surround

| | | | | | | | | |
|-------------|-----------------|-------|--------|----|----|----|----|---|
| CUST-2215-F | Custom surround | HTI 1 | \$ 989 | 14 | 14 | 21 | 14 | Y |
|-------------|-----------------|-------|--------|----|----|----|----|---|

Venting (Required to Complete)**Gas Insert Venting - 30/30 Termination Kits**

| | | | | | | | | |
|----------------|--|-------|--------|---|---|----|----|---|
| LINK-DV4-30B | Direct vent insert kit - one 4 - liner, one 30 - liner, plus term cap components | HTI 1 | \$ 549 | Y | Y | Y | Y | Y |
| LINK-DV30B | Direct vent insert kit - two 30 - liners, plus term cap components | HTI 1 | \$ 649 | Y | Y | Y | Y | Y |
| LINKSQB-DV4-30 | Direct vent insert kit - one 4 - liner, one 30 - liner, plus black term cap components | HTI 1 | \$ 649 | Y | Y | 14 | 14 | Y |
| LINKSQB-DV30 | Direct vent insert kit - two 30 - liners, plus black term cap components | HTI 1 | \$ 729 | Y | Y | Y | 14 | Y |
| LINKSQC-DV30 | Direct vent insert kit - two 30" liners, plus faux copper term cap components | HTI 1 | \$ 789 | Y | Y | Y | 14 | Y |

Gas Insert Venting - Components

| | | | | | | | | |
|--------------|---|-------|-------|---|---|----|----|---|
| LINK-ZC-ADPB | 14 1/2" round flashing adapter kit (for use with existing liner kits when using Class A pipe) | HTI 1 | \$ 90 | Y | Y | 14 | 14 | Y |
|--------------|---|-------|-------|---|---|----|----|---|

Control, remotes, wall switches**IntelliFire app**

| | | | | | | | | |
|---------|---|-------|--------|---|---|---|---|---|
| IFT-WFM | IntelliFire Wi-Fi Module that works with the IntelliFire iOS and Android app. Use to control all the features of your fireplace via a smart device. An RC400, RC450 or RC150 is required for thermostat control | HTI 1 | \$ 229 | Y | Y | Y | Y | Y |
|---------|---|-------|--------|---|---|---|---|---|

Touch Screen Remote

| | | | | | | | | |
|-----------|---|-------|--------|---|---|---|---|---|
| IFT-RC400 | IntelliFire Touch black remote control, docking station and auxiliary control module (on/off, flame height, thermostat mode, fan control, child lock, cold climate, timer mode, hot indicator, lights, on-screen maintenance and troubleshooting notifications) | HTI 1 | \$ 389 | Y | Y | Y | Y | Y |
|-----------|---|-------|--------|---|---|---|---|---|

Wall Switch

| | | | | | | | |
|---------------|---|--------------|---|---|---|---|---|
| IFT-RC150-HNG | IntelliFire Touch white wireless wall switch (on/off, cold climate, battery strength indicator) | HNG 1 \$ 121 | Y | Y | Y | Y | Y |
|---------------|---|--------------|---|---|---|---|---|



IntelliFire app

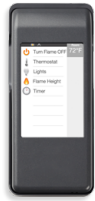

Touch Screen Remote



Wall Switch

Venting Notes

Requires: LINK-DV30B, LINKSQB-DV30, LINKSQC-DV30, LINK-DV4-30B, LINKSQB-DV4-30 or LINKSQC-DV4-30 flex liner kit. Refer to Venting section

Provident Insert 30"

Includes:

- 21,000 - 30,000 BTU/Hour Input (NG) • 4 Ceramic Fiber Logs
- 19,600 - 28,000 BTU/Hour Input (LP)
- IntelliFire Ignition System
- Ceramic Glass
- Glowing Embers/Lava Rock
- Battery Back Up
- Electrical Cord - 10' 3" Left, X 7' 6" Right
- Gas Flex Connector



Special Considerations:

- LP requires conversion, order LPK-MI-IPI

Required to Complete - Sold Separately: • Front • Surround

| | | Disc. Code | MSRP USD | 004 IA | 010 PA | 014 CA | 016 NC | EXP |
|--------------|---|------------|----------|--------|--------|--------|--------|-----|
| PROV-I30-IPI | Provident Medium 30" direct vent gas insert with IPI ignition system (NG) | HNG 3 | \$ 2,209 | Y | 14 | Y | Y | N |

Fronts - Non-Operable (Required to Complete)

Firescreen

| | | | | | | | | |
|------------|--|-------|--------|----|---|---|----|---|
| FS-MI30-BK | Firescreen 30" screen front - Black | HNG 3 | \$ 419 | Y | Y | Y | Y | Y |
| FS-MI30-NB | Firescreen 30" screen front - New Bronze | HNG 3 | \$ 439 | Y | Y | Y | 21 | Y |
| FS-MI30-GM | Firescreen 30" screen front - Gun Metal | HNG 3 | \$ 439 | 14 | Y | Y | 14 | Y |

Inside Fit

| | | | | | | | | |
|-------------|-------------------------------------|-------|--------|---|---|---|----|---|
| INFIT-30-BK | Inside fit 30" screen front - Black | HTI 3 | \$ 369 | Y | Y | Y | 14 | Y |
|-------------|-------------------------------------|-------|--------|---|---|---|----|---|



Firescreen



Inside Fit

Metal Surrounds (Required to Complete)

Surrounds - Small

| | | | | | | | | |
|--------------|---|-------|--------|----|----|----|----|---|
| MI30-4027-BK | Small 30" surround 40" x 27" - Black | HTI 3 | \$ 379 | Y | Y | Y | Y | Y |
| MI30-4027-NB | Small 30" surround 40" x 27" - New Bronze | HTI 3 | \$ 419 | Y | 14 | Y | 21 | Y |
| MI30-4027-GM | Small 30" surround 40" x 27" - Gun Metal | HNG 3 | \$ 419 | 14 | 14 | 14 | 14 | Y |

Surrounds - Medium

| | | | | | | | | |
|---------------|---|-------|--------|----|---|----|----|---|
| MI30-4230-BK | Medium 30" surround 42" x 30" - Black | HTI 3 | \$ 409 | Y | Y | Y | Y | Y |
| MI30-4230D-BK | Medium 30" surround 42" x 30" x 2" deep - Black | HTI 3 | \$ 409 | Y | Y | Y | 14 | Y |
| MI30-4230-NB | Medium 30" surround 42" x 30" - New Bronze | HTI 3 | \$ 439 | Y | Y | Y | 14 | Y |
| MI30-4230-GM | Medium 30" surround 42" x 30" - Gun Metal | HNG 3 | \$ 439 | 14 | Y | 14 | 14 | Y |

| Surrounds - Large | | | | | | | | | | |
|---|--|-------|--------|----|----|----|----|---|--|--|
| MI30-4432-BK | Large 30" surround 44" x 32" - Black | HTI 3 | \$ 429 | Y | Y | Y | 14 | Y | | |
| MI30-4432-NB | Large 30" surround 44" x 32" - New Bronze | HTI 3 | \$ 469 | Y | 14 | Y | 14 | Y | | |
| MI30-4432-GM | Large 30" surround 44" x 32" - Gun Metal | HNG 3 | \$ 469 | 14 | 14 | 14 | 14 | Y | | |
| Custom Surround | | | | | | | | | | |
| MI30-5040CS-BK | On site 30" customizable surround - 50" w x 40" h (comes 4 sided with a 6" bottom, can be trimmed to make 3 sided) | HTI 3 | \$ 489 | Y | Y | Y | Y | N | | |
| CUST-SRND-MI | Custom surround metal inserts (see custom surround order form for details) | HTI 3 | \$ 859 | 14 | 14 | 21 | 14 | Y | | |
| Venting (Required to Complete) | | | | | | | | | | |
| Gas Insert Venting - 30/30 Termination Kits | | | | | | | | | | |
| LINK-DV4-30B | Direct vent insert kit - one 4 - liner, one 30 - liner, plus term cap components | HTI 1 | \$ 549 | Y | Y | Y | Y | Y | | |
| LINKSQB-DV4-30 | Direct vent insert kit - one 4 - liner, one 30 - liner, plus black term cap components | HTI 1 | \$ 649 | Y | Y | 14 | 14 | Y | | |
| LINK-DV30B | Direct vent insert kit - two 30 - liners, plus term cap components | HTI 1 | \$ 649 | Y | Y | Y | Y | Y | | |
| LINKSQB-DV30 | Direct vent insert kit - two 30 - liners, plus black term cap components | HTI 1 | \$ 729 | Y | Y | Y | 14 | Y | | |
| LINKSQC-DV30 | Direct vent insert kit - two 30" liners, plus faux copper term cap components | HTI 1 | \$ 789 | Y | Y | Y | 14 | Y | | |
| Gas Insert Venting - Components | | | | | | | | | | |
| LINK-ZC-ADPB | 14 1/2" round flashing adapter kit (for use with existing liner kits when using Class A pipe) | HTI 1 | \$ 90 | Y | Y | 14 | 14 | Y | | |
| Conversion Kit | | | | | | | | | | |
| Conversion Kit | | | | | | | | | | |
| LPK-MI-IPI | LP conversion kit for metal insert with IPI | HTI 3 | \$ 0 | Y | Y | Y | 14 | Y | | |
| Refractory Upgrade | | | | | | | | | | |
| Fiber Refractory | | | | | | | | | | |
| BRICK-MI30-TR | Traditional 30" Brick interior panels - Stratford | HNG 3 | \$ 299 | Y | Y | Y | 14 | Y | | |
| Fans | | | | | | | | | | |
| Fan | | | | | | | | | | |
| GFK-160C | Fan kit 160 CFM (fan only) | HTI 1 | \$ 259 | Y | Y | Y | Y | Y | | |
| GFK-160A | Fan kit 160 CFM (includes rheostat and temperature sensor) | HTI 1 | \$ 319 | Y | Y | Y | Y | Y | | |
| Control, remotes, wall switches | | | | | | | | | | |
| Smart Stat Remote Control | | | | | | | | | | |
| SMART-STAT-HHT | Remote Control - IPI or SP (on/off, temp readout, thermostat mode, timer mode) | HTI 1 | \$ 289 | Y | Y | Y | Y | Y | | |
| Venting Notes | | | | | | | | | | |
| Requires: LINK-DV30B, LINKSQB-DV30, LINKSQC-DV30, LINK-DV4-30B, LINKSQB-DV-30 or LINKSQC-DV4-30 flex liner kit. Refer to Venting section. | | | | | | | | | | |

Provident Insert 35"

Includes:

- 22,890 - 32,700 BTU/Hour Input (NG)
- 22,400 - 32,000 BTU/Hour Input (LP)
- IntelliFire Ignition System
- Ceramic Glass
- Glowing Embers/Lava Rock
- Battery Back Up
- Electrical Cord - 10' Left, X 7' Right
- Gas Flex Connector
- 4 Ceramic Fiber Logs
- LP requires conversion, order LPK-MI-IPI



Required to Complete - Sold Separately: • Front • Surround

| | | Disc. Code | MSRP USD | 004 IA | 010 PA | 014 CA | 016 NC | EXP |
|--------------|--|------------|----------|--------|--------|--------|--------|-----|
| PROV-I35-IPI | Provident large 35" direct vent gas insert with IPI ignition system (NG) | HNG 3 | \$ 2,359 | 14 | 14 | Y | Y | N |

Fronts - Non-Operable (Required to Complete)

Firescreen

| | | | | | | | | |
|------------|--|-------|--------|----|----|----|----|---|
| FS-MI35-BK | Firescreen 35" screen front - Black | HNG 3 | \$ 439 | Y | Y | Y | Y | Y |
| FS-MI35-NB | Firescreen 35" screen front - New Bronze | HNG 3 | \$ 469 | Y | 14 | Y | 14 | Y |
| FS-MI35-GM | Firescreen 35" screen front - Gun Metal | HNG 3 | \$ 469 | 14 | 14 | 14 | 14 | Y |

Inside Fit

| | | | | | | | | |
|-------------|-------------------------------------|-------|--------|---|---|----|----|---|
| INFIT-35-BK | Inside fit 35" screen front - Black | HTI 3 | \$ 399 | Y | Y | 14 | 14 | Y |
|-------------|-------------------------------------|-------|--------|---|---|----|----|---|



Firescreen



Inside Fit

Metal Surrounds (Required to Complete)

Surrounds - Small

| | | | | | | | | |
|--------------|---|-------|--------|----|----|----|----|---|
| MI35-4229-BK | Small 35" surround 42" x 29" - Black | HTI 3 | \$ 409 | Y | Y | Y | Y | Y |
| MI35-4229-NB | Small 35" surround 42" x 29" - New Bronze | HTI 3 | \$ 439 | Y | 14 | Y | 14 | Y |
| MI35-4229-GM | Small 35" surround 42" x 29" - Gun Metal | HNG 3 | \$ 439 | 14 | 14 | 14 | 14 | Y |

Surrounds - Medium

| | | | | | | | | |
|---------------|---|-------|--------|----|----|----|----|---|
| MI35-4432-BK | Medium 35" surround 44" x 32" - Black | HTI 3 | \$ 429 | Y | Y | Y | Y | Y |
| MI35-4432D-BK | Medium 35" surround 44" x 32" x 2" deep - Black | HTI 3 | \$ 429 | 14 | 14 | Y | 14 | Y |
| MI35-4432-GM | Medium 35" surround 44" x 32" - Gun Metal | HNG 3 | \$ 469 | 14 | 14 | 14 | 14 | Y |
| MI35-4432-NB | Medium 35" surround 44" x 32" - New Bronze | HTI 3 | \$ 469 | 14 | 14 | Y | 14 | Y |

| Surrounds - Large | | | | | | | | | | |
|---|--|-------|--------|----|----|----|----|---|--|--|
| MI35-4832-BK | Large 35" surround 48" x 32" - Black | HTI 3 | \$ 459 | Y | Y | Y | 14 | Y | | |
| MI35-4832-GM | Large 35" surround 48" x 32" - Gun Metal | HNG 3 | \$ 489 | 14 | 14 | 14 | 14 | Y | | |
| MI35-4832-NB | Large 35" surround 48" x 32" - New Bronze | HTI 3 | \$ 489 | 14 | 14 | 14 | 14 | Y | | |
| Custom Surround | | | | | | | | | | |
| MI35-5040CS-BK | On site 35" customizable surround - 50" w x 40" h (comes 4 sided with a 5" bottom, can be trimmed to make 3 sided) | HTI 3 | \$ 509 | Y | Y | Y | Y | Y | | |
| CUST-SRND-MI | Custom surround metal inserts (see custom surround order form for details) | HTI 3 | \$ 859 | 14 | 14 | 21 | 14 | Y | | |
| Venting (Required to Complete) | | | | | | | | | | |
| Gas Insert Venting - 30/30 Termination Kits | | | | | | | | | | |
| LINK-DV4-30B | Direct vent insert kit - one 4 - liner, one 30 - liner, plus term cap components | HTI 1 | \$ 549 | Y | Y | Y | Y | Y | | |
| LINKSQB-DV4-30 | Direct vent insert kit - one 4 - liner, one 30 - liner, plus black term cap components | HTI 1 | \$ 649 | Y | Y | 14 | 14 | Y | | |
| LINK-DV30B | Direct vent insert kit - two 30 - liners, plus term cap components | HTI 1 | \$ 649 | Y | Y | Y | Y | Y | | |
| LINKSQB-DV30 | Direct vent insert kit - two 30 - liners, plus black term cap components | HTI 1 | \$ 729 | Y | Y | Y | 14 | Y | | |
| LINKSQC-DV30 | Direct vent insert kit - two 30" liners, plus faux copper term cap components | HTI 1 | \$ 789 | Y | Y | Y | 14 | Y | | |
| Gas Insert Venting - Components | | | | | | | | | | |
| LINK-ZC-ADPB | 14 1/2" round flashing adapter kit (for use with existing liner kits when using Class A pipe) | HTI 1 | \$ 90 | Y | Y | 14 | 14 | Y | | |
| Conversion Kit | | | | | | | | | | |
| Conversion Kit | | | | | | | | | | |
| LPK-MI-IPI | LP conversion kit for metal insert with IPI | HTI 3 | \$ 0 | Y | Y | Y | 14 | Y | | |
| Refractory Upgrade | | | | | | | | | | |
| Fiber Refractory | | | | | | | | | | |
| BRICK-MI35-TR | Traditional 35" Brick interior panels - Stratford | HNG 3 | \$ 309 | Y | Y | Y | 14 | Y | | |
| Fans | | | | | | | | | | |
| Fan | | | | | | | | | | |
| GFK-160C | Fan kit 160 CFM (fan only) | HTI 1 | \$ 259 | Y | Y | Y | Y | Y | | |
| GFK-160A | Fan kit 160 CFM (includes rheostat and temperature sensor) | HTI 1 | \$ 319 | Y | Y | Y | Y | Y | | |
| Control, remotes, wall switches | | | | | | | | | | |
| Smart Stat Remote Control | | | | | | | | | | |
| SMART-STAT-HHT | Remote Control - IPI or SP (on/off, temp readout, thermostat mode, timer mode) | HTI 1 | \$ 289 | Y | Y | Y | Y | Y | | |
| Venting Notes | | | | | | | | | | |
| Requires: LINK-DV30B, LINKSQB-DV30, LINKSQC-DV30, LINK-DV4-30B, LINKSQB-DV-30 or LINKSQC-DV4-30 flex liner kit. Refer to Venting section. | | | | | | | | | | |

Supreme Insert 25"

Includes:

- 18,900 - 27,000 BTU/Hour Input (NG)
- 17,500 - 25,000 BTU/Hour Input (LP)
- IntelliFire Touch Ignition System
- RC400 Remote Control
- GFK-160A Variable Fan
- Decorative Brick Base
- Ceramic Glass
- Glowing Embers/Mystic Embers
- Battery Back Up
- Electrical Cord - 10' 6" Left, X 8" Right
- Gas Flex Connector
- 5 Ceramic Fiber Logs



Special Considerations:

- LP requires conversion, order LPK-MI-IFT

Required to Complete - Sold Separately: • Front • Surround

| | | Disc. Code | MSRP USD | 004 IA | 010 PA | 014 CA | 016 NC | EXP |
|-----------------|--|------------|----------|--------|--------|--------|--------|-----|
| SUPREME-I25-IFT | Supreme small 25" direct vent gas insert with IntelliFire touch ignition system (NG) | HNG 3 | \$ 2,799 | Y | Y | Y | Y | N |
| SUPREME-I25-BIR | Supreme with birch logs - small 25" direct vent gas insert with IntelliFire touch ignition system (NG) | HNG 3 | \$ 2,999 | Y | 14 | Y | 14 | N |

Fronts - Non-Operable (Required to Complete)

Firescreen

| | | | | | | | | |
|------------|--|-------|--------|----|----|----|----|---|
| FS-MI25-BK | Firescreen 25" screen front - Black | HNG 3 | \$ 399 | Y | Y | Y | Y | Y |
| FS-MI25-GM | Firescreen 25" screen front - Gun Metal | HNG 3 | \$ 419 | 14 | 14 | 14 | 14 | Y |
| FS-MI25-NB | Firescreen 25" screen front - New Bronze | HNG 3 | \$ 419 | 14 | 14 | 14 | 14 | Y |

Halston Arch

| | | | | | | | | |
|--------------|--|-------|--------|----|----|----|----|---|
| HARC-MI25-BK | Halston arched 25" screen front - Black | HNG 3 | \$ 719 | 14 | Y | 14 | 14 | Y |
| HARC-MI25-NB | Halston arched 25" screen front - New Bronze | HNG 3 | \$ 779 | 14 | 14 | 14 | 14 | Y |
| HARC-MI25-GM | Halston arched 25" screen front - Gun Metal | HNG 3 | \$ 779 | 14 | 14 | 14 | 14 | Y |

Inside Fit

| | | | | | | | | |
|-------------|-------------------------------------|-------|--------|---|---|---|----|---|
| INFIT-25-BK | Inside fit 25" screen front - Black | HTI 3 | \$ 349 | Y | Y | Y | 14 | Y |
|-------------|-------------------------------------|-------|--------|---|---|---|----|---|

Iron Age

| | | | | | | | | |
|------------|--|-------|--------|----|----|----|----|---|
| IA-MI25-BK | Iron Age 25" screen front - Black | HNG 3 | \$ 569 | 14 | 14 | 14 | 14 | Y |
| IA-MI25-NB | Iron Age 25" screen front - New Bronze | HNG 3 | \$ 619 | 14 | 14 | 14 | 14 | Y |
| IA-MI25-GM | Iron Age 25" screen front - Gun Metal | HNG 3 | \$ 629 | 14 | 14 | 14 | 14 | Y |



Firescreen



Halston Arch



Inside Fit



Iron Age

Metal Surrounds (Required to Complete)**Surrounds - Small**

| | | | | | | | | |
|--------------|---|-------|--------|----|----|----|----|---|
| MI25-3523-BK | Small 25" surround 35" x 23" - Black | HTI 3 | \$ 359 | Y | Y | Y | Y | Y |
| MI25-3523-GM | Small 25" surround 35" x 23" - Gun Metal | HNG 3 | \$ 399 | 14 | 14 | 14 | 14 | Y |
| MI25-3523-NB | Small 25" surround 35" x 23" - New Bronze | HTI 3 | \$ 399 | 14 | 14 | 14 | 14 | Y |

Surrounds - Medium

| | | | | | | | | |
|--------------|--|-------|--------|----|----|----|----|---|
| MI25-3726-BK | Medium 25" surround 37" x 26" - Black | HTI 3 | \$ 379 | Y | Y | Y | Y | Y |
| MI25-3726-NB | Medium 25" surround 37" x 26" - New Bronze | HTI 3 | \$ 419 | 14 | 14 | 14 | 14 | Y |
| MI25-3726-GM | Medium 25" surround 37" x 26" - Gun Metal | HNG 3 | \$ 419 | 14 | 14 | 14 | 14 | Y |

Surrounds - Large

| | | | | | | | | |
|--------------|---|-------|--------|----|----|----|----|---|
| MI25-3928-BK | Large 25" surround 39" x 28" - Black | HTI 3 | \$ 409 | Y | Y | Y | 14 | Y |
| MI25-3928-NB | Large 25" surround 39" x 28" - New Bronze | HTI 3 | \$ 439 | 14 | 14 | 14 | 14 | Y |
| MI25-3928-GM | Large 25" surround 39" x 28" - Gun Metal | HNG 3 | \$ 439 | 14 | 14 | 14 | 14 | Y |

Custom Surround

| | | | | | | | | |
|----------------|---|-------|--------|----|----|----|----|---|
| MI-USBC-RELO | Relocation kit for USB-C and reset switch from surround to under the front. For use when using inside fit or onsite surround. | HTI 3 | \$ 37 | Y | Y | Y | 14 | Y |
| MI25-5040CS-BK | On site 25" customizable surround - 50" w x 40" h (comes 4 sided with a 6" bottom, can be trimmed to make 3 sided) | HTI 3 | \$ 469 | Y | Y | Y | Y | N |
| CUST-SRND-MI | Custom surround metal inserts (see custom surround order form for details) | HTI 3 | \$ 859 | 14 | 14 | 21 | 14 | Y |

Venting (Required to Complete)**Gas Insert Venting - 30/30 Termination Kits**

| | | | | | | | | |
|----------------|--|-------|--------|---|---|----|----|---|
| LINK-DV4-30B | Direct vent insert kit - one 4 - liner, one 30 - liner, plus term cap components | HTI 1 | \$ 549 | Y | Y | Y | Y | Y |
| LINK-DV30B | Direct vent insert kit - two 30 - liners, plus term cap components | HTI 1 | \$ 649 | Y | Y | Y | Y | Y |
| LINKSQB-DV4-30 | Direct vent insert kit - one 4 - liner, one 30 - liner, plus black term cap components | HTI 1 | \$ 649 | Y | Y | 14 | 14 | Y |
| LINKSQB-DV30 | Direct vent insert kit - two 30 - liners, plus black term cap components | HTI 1 | \$ 729 | Y | Y | Y | 14 | Y |
| LINKSQC-DV30 | Direct vent insert kit - two 30" liners, plus faux copper term cap components | HTI 1 | \$ 789 | Y | Y | Y | 14 | Y |

Gas Insert Venting - Components

| | | | | | | | | |
|--------------|---|-------|-------|---|---|----|----|---|
| LINK-ZC-ADPB | 14 1/2" round flashing adapter kit (for use with existing liner kits when using Class A pipe) | HTI 1 | \$ 90 | Y | Y | 14 | 14 | Y |
|--------------|---|-------|-------|---|---|----|----|---|

Conversion Kit**Conversion Kit**

| | | | | | | | | |
|------------|---|-------|------|--|---|---|---|---|
| LPK-MI-IFT | LP conversion kit for metal insert with IntelliFire Touch | HTI 3 | \$ 0 | | Y | Y | Y | Y |
|------------|---|-------|------|--|---|---|---|---|

Liner Kit**Glass Liner**

| | | | | | | | | |
|-------------|--|-------|--------|---|---|---|----|---|
| LINER-BK-25 | Reflective Black Glass Liner 25" traditional units | HTI 3 | \$ 509 | Y | Y | Y | 14 | Y |
|-------------|--|-------|--------|---|---|---|----|---|

Refractory Upgrade**Fiber Refractory**

| | | | | | | | | |
|---------------|---|-------|--------|---|---|---|----|---|
| BRICK-MI25-TR | Traditional 25" Brick interior panels - Stratford | HNG 3 | \$ 289 | Y | Y | Y | 14 | Y |
|---------------|---|-------|--------|---|---|---|----|---|

Fiber Refractory

| | | | | | | | | |
|---------------|---|-------|--------|---|----|---|----|---|
| BRICK-MI25-HB | Herringbone 25" Brick interior panels - Tranquil Greige | HNG 3 | \$ 309 | Y | 14 | Y | 14 | Y |
|---------------|---|-------|--------|---|----|---|----|---|

Control, remotes, wall switches

Battery Back Up

| | | | | | | | | |
|-------------|--|-------|--------|---|----|---|----|---|
| BATTERY-WSK | Battery backup wall switch kit for units with IFT control systems. Includes: On/Off Wall Switch, USB-C Port, Battery Backup, Cover Plate, 12' Wire Harness | HTI 1 | \$ 189 | Y | 14 | Y | 14 | Y |
|-------------|--|-------|--------|---|----|---|----|---|

IntelliFire app

| | | | | | | | | |
|---------|---|-------|--------|---|---|---|---|---|
| IFT-WFM | IntelliFire Wi-Fi Module that works with the IntelliFire iOS and Android app. Use to control all the features of your fireplace via a smart device. An RC400, RC450 or RC150 is required for thermostat control | HTI 1 | \$ 229 | Y | Y | Y | Y | Y |
|---------|---|-------|--------|---|---|---|---|---|

Touch Screen Remote

| | | | | | | | | |
|-----------|---|-------|--------|---|---|---|---|---|
| IFT-RC400 | IntelliFire Touch black remote control, docking station and auxiliary control module (on/off, flame height, thermostat mode, fan control, child lock, cold climate, timer mode, hot indicator, lights, on-screen maintenance and troubleshooting notifications) | HTI 1 | \$ 389 | Y | Y | Y | Y | Y |
|-----------|---|-------|--------|---|---|---|---|---|

Wall Switch

| | | | | | | | | |
|---------------|---|-------|--------|---|---|---|---|---|
| IFT-RC150-HNG | IntelliFire Touch white wireless wall switch (on/off, cold climate, battery strength indicator) | HNG 1 | \$ 121 | Y | Y | Y | Y | Y |
|---------------|---|-------|--------|---|---|---|---|---|



Battery Back Up



IntelliFire app

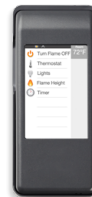

Touch Screen Remote



Wall Switch

Venting Notes

Requires: LINK-DV30B, LINKSQB-DV30, LINKSQC-DV30, LINK-DV4-30B, LINKSQB-DV-30 or LINKSQC-DV4-30 flex liner kit. Refer to Venting section.

Supreme Insert 30"

Includes:

- 22,890 - 32,700 BTU/Hour Input (NG)
- 22,400 - 32,000 BTU/Hour Input (LP)
- IntelliFire Touch Ignition System
- RC400 Remote Control
- GFK-160A Variable Fan
- Decorative Brick Base
- Ceramic Glass
- Glowing Embers/Mystic Embers
- Battery Back Up
- Electrical Cord - 10' 3" Left, X 7' 6" Right
- Gas Flex Connector
- 5 Ceramic Fiber Logs



Special Considerations:

- BIR unit requires LP conversion, order LPK-MI-IFT

Required to Complete - Sold Separately: • Front • Surround

| | | Disc. Code | MSRP USD | 004 IA | 010 PA | 014 CA | 016 NC | EXP |
|-----------------|---|------------|----------|--------|--------|--------|--------|-----|
| SUPREME-I30-IFT | Supreme medium 30" direct vent gas insert with IntelliFire touch ignition system (NG) | HNG 3 | \$ 2,969 | Y | Y | Y | Y | N |
| SUPRM-I30LP-IFT | Supreme medium 30" direct vent gas insert with IntelliFire touch ignition system (LP) | HNG 3 | \$ 3,039 | Y | Y | Y | 14 | N |
| SUPREME-I30-BIR | Supreme with birch logs - medium 30" direct vent gas insert with IntelliFire touch ignition system (NG) | HNG 3 | \$ 3,169 | Y | Y | Y | 14 | N |

Fronts - Non-Operable (Required to Complete)

Firescreen

| | | | | | | | | |
|------------|--|-------|--------|----|---|---|----|---|
| FS-MI30-BK | Firescreen 30" screen front - Black | HNG 3 | \$ 419 | Y | Y | Y | Y | Y |
| FS-MI30-GM | Firescreen 30" screen front - Gun Metal | HNG 3 | \$ 439 | 14 | Y | Y | 14 | Y |
| FS-MI30-NB | Firescreen 30" screen front - New Bronze | HNG 3 | \$ 439 | Y | Y | Y | 21 | Y |

Halston Arch

| | | | | | | | | |
|--------------|--|-------|--------|---|----|----|----|---|
| HARC-MI30-BK | Halston arched 30" screen front - Black | HNG 3 | \$ 779 | Y | Y | Y | 21 | Y |
| HARC-MI30-GM | Halston arched 30" screen front - Gun Metal | HNG 3 | \$ 819 | Y | 14 | 14 | 14 | Y |
| HARC-MI30-NB | Halston arched 30" screen front - New Bronze | HNG 3 | \$ 819 | Y | Y | Y | 14 | Y |

Inside Fit

| | | | | | | | | |
|-------------|-------------------------------------|-------|--------|---|---|---|----|---|
| INFIT-30-BK | Inside fit 30" screen front - Black | HTI 3 | \$ 369 | Y | Y | Y | 14 | Y |
|-------------|-------------------------------------|-------|--------|---|---|---|----|---|

Iron Age

| | | | | | | | | |
|------------|--|-------|--------|----|----|----|----|---|
| IA-MI30-BK | Iron Age 30" screen front - Black | HNG 3 | \$ 619 | Y | Y | Y | 14 | Y |
| IA-MI30-NB | Iron Age 30" screen front - New Bronze | HNG 3 | \$ 669 | Y | 14 | Y | 14 | Y |
| IA-MI30-GM | Iron Age 30" screen front - Gun Metal | HNG 3 | \$ 669 | 14 | Y | 14 | 14 | Y |



Firescreen



Halston Arch



Inside Fit



Iron Age

Metal Surrounds (Required to Complete)**Surrounds - Small**

| | | | | | | | | |
|--------------|---|-------|--------|----|----|----|----|---|
| MI30-4027-BK | Small 30" surround 40" x 27" - Black | HTI 3 | \$ 379 | Y | Y | Y | Y | Y |
| MI30-4027-NB | Small 30" surround 40" x 27" - New Bronze | HTI 3 | \$ 419 | Y | 14 | Y | 21 | Y |
| MI30-4027-GM | Small 30" surround 40" x 27" - Gun Metal | HNG 3 | \$ 419 | 14 | 14 | 14 | 14 | Y |

Surrounds - Medium

| | | | | | | | | |
|---------------|---|-------|--------|----|---|----|----|---|
| MI30-4230-BK | Medium 30" surround 42" x 30" - Black | HTI 3 | \$ 409 | Y | Y | Y | Y | Y |
| MI30-4230D-BK | Medium 30" surround 42" x 30" x 2" deep - Black | HTI 3 | \$ 409 | Y | Y | Y | 14 | Y |
| MI30-4230-GM | Medium 30" surround 42" x 30" - Gun Metal | HNG 3 | \$ 439 | 14 | Y | 14 | 14 | Y |
| MI30-4230-NB | Medium 30" surround 42" x 30" - New Bronze | HTI 3 | \$ 439 | Y | Y | Y | 14 | Y |

Surrounds - Large

| | | | | | | | | |
|--------------|---|-------|--------|----|----|----|----|---|
| MI30-4432-BK | Large 30" surround 44" x 32" - Black | HTI 3 | \$ 429 | Y | Y | Y | 14 | Y |
| MI30-4432-GM | Large 30" surround 44" x 32" - Gun Metal | HNG 3 | \$ 469 | 14 | 14 | 14 | 14 | Y |
| MI30-4432-NB | Large 30" surround 44" x 32" - New Bronze | HTI 3 | \$ 469 | Y | 14 | Y | 14 | Y |

Custom Surround

| | | | | | | | | |
|----------------|---|-------|--------|----|----|----|----|---|
| MI-USBC-RELO | Relocation kit for USB-C and reset switch from surround to under the front. For use when using inside fit or onsite surround. | HTI 3 | \$ 37 | Y | Y | Y | 14 | Y |
| MI30-5040CS-BK | On site 30" customizable surround - 50" w x 40" h (comes 4 sided with a 6" bottom, can be trimmed to make 3 sided) | HTI 3 | \$ 489 | Y | Y | Y | Y | N |
| CUST-SRND-MI | Custom surround metal inserts (see custom surround order form for details) | HTI 3 | \$ 859 | 14 | 14 | 21 | 14 | Y |

Venting (Required to Complete)**Gas Insert Venting - 30/30 Termination Kits**

| | | | | | | | | |
|----------------|--|-------|--------|---|---|----|----|---|
| LINK-DV4-30B | Direct vent insert kit - one 4 - liner, one 30 - liner, plus term cap components | HTI 1 | \$ 549 | Y | Y | Y | Y | Y |
| LINKSQB-DV4-30 | Direct vent insert kit - one 4 - liner, one 30 - liner, plus black term cap components | HTI 1 | \$ 649 | Y | Y | 14 | 14 | Y |
| LINK-DV30B | Direct vent insert kit - two 30 - liners, plus term cap components | HTI 1 | \$ 649 | Y | Y | Y | Y | Y |
| LINKSQB-DV30 | Direct vent insert kit - two 30 - liners, plus black term cap components | HTI 1 | \$ 729 | Y | Y | Y | 14 | Y |
| LINKSQC-DV30 | Direct vent insert kit - two 30" liners, plus faux copper term cap components | HTI 1 | \$ 789 | Y | Y | Y | 14 | Y |

Gas Insert Venting - Components

| | | | | | | | | |
|--------------|---|-------|-------|---|---|----|----|---|
| LINK-ZC-ADPB | 14 1/2" round flashing adapter kit (for use with existing liner kits when using Class A pipe) | HTI 1 | \$ 90 | Y | Y | 14 | 14 | Y |
|--------------|---|-------|-------|---|---|----|----|---|

Conversion Kit**Conversion Kit**

| | | | | | | | | |
|------------|---|-------|------|--|---|---|---|---|
| LPK-MI-IFT | LP conversion kit for metal insert with IntelliFire Touch | HTI 3 | \$ 0 | | Y | Y | Y | Y |
|------------|---|-------|------|--|---|---|---|---|

Lighting**Accent Light Kit**

| | | | | | | | | |
|--------|---|-------|--------|---|---|---|----|---|
| MI-ALK | Ambient Light Kit (not for use in 25" models) (Not recommended for use with Reflective Black Glass Liner) | HTI 3 | \$ 499 | Y | Y | Y | 14 | Y |
|--------|---|-------|--------|---|---|---|----|---|

Liner Kit**Glass Liner**

| | | | | | | | | |
|-------------|--|-------|--------|---|---|---|----|---|
| LINER-BK-30 | Reflective Black Glass Liner 30" traditional units | HTI 3 | \$ 549 | Y | Y | Y | 14 | Y |
|-------------|--|-------|--------|---|---|---|----|---|

| Refractory Upgrade | | | | | | |
|---------------------------------|---|-------|----|-----|---|----|
| Fiber Refractory | | | | | | |
| BRICK-MI30-TR | Traditional 30" Brick interior panels - Stratford | HNG 3 | \$ | 299 | Y | Y |
| Fiber Refractory | | | | | | |
| BRICK-MI30-HB | Herringbone 30" Brick interior panels - Tranquil Greige | HNG 3 | \$ | 329 | Y | Y |
| Control, remotes, wall switches | | | | | | |
| Battery Back Up | | | | | | |
| BATTERY-WSK | Battery backup wall switch kit for units with IFT control systems. Includes: On/Off Wall Switch, USB-C Port, Battery Backup, Cover Plate, 12' Wire Harness | HTI 1 | \$ | 189 | Y | 14 |
| IntelliFire app | | | | | | |
| IFT-WFM | IntelliFire Wi-Fi Module that works with the IntelliFire iOS and Android app. Use to control all the features of your fireplace via a smart device. An RC400, RC450 or RC150 is required for thermostat control | HTI 1 | \$ | 229 | Y | Y |
| Touch Screen Remote | | | | | | |
| IFT-RC400 | IntelliFire Touch black remote control, docking station and auxiliary control module (on/off, flame height, thermostat mode, fan control, child lock, cold climate, timer mode, hot indicator, lights, on-screen maintenance and troubleshooting notifications) | HTI 1 | \$ | 389 | Y | Y |
| Wall Switch | | | | | | |
| IFT-RC150-HNG | IntelliFire Touch white wireless wall switch (on/off, cold climate, battery strength indicator) | HNG 1 | \$ | 121 | Y | Y |



Battery Back Up



IntelliFire app

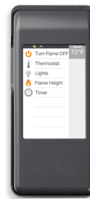

Touch Screen Remote



Wall Switch

Venting Notes

Requires: LINK-DV30B, LINKSQB-DV30, LINKSQC-DV30, LINK-DV4-30B, LINKSQB-DV-30 or LINKSQC-DV4-30 flex liner kit. Refer to Venting section.

Supreme Insert 35"

Includes:

- 24,500 - 35,000 BTU/Hour Input (NG)
- 24,500 - 35,000 BTU/Hour Input (LP)
- IntelliFire Touch Ignition System
- RC400 Remote Control
- GFK-160A Variable Fan
- Decorative Brick Base
- Ceramic Glass
- Glowing Embers/Mystic Embers
- Battery Back Up
- Electrical Cord - 10" Left, X 7' Right
- Gas Flex Connector
- 6 Ceramic Fiber Logs



Special Considerations:

- LP requires conversion, order LPK-MI-IFT

Required to Complete - Sold Separately: • Front • Surround

| | | Disc. Code | MSRP USD | 004 IA | 010 PA | 014 CA | 016 NC | EXP |
|-----------------|--|------------|----------|--------|--------|--------|--------|-----|
| SUPREME-I35-IFT | Supreme large 35" direct vent gas insert with IntelliFire touch ignition system (NG) | HNG 3 | \$ 3,099 | Y | Y | Y | Y | N |
| SUPREME-I35-BIR | Supreme with birch logs - large 35" direct vent gas insert with IntelliFire touch ignition system (NG) | HNG 3 | \$ 3,299 | 14 | Y | Y | 14 | N |

Fronts - Non-Operable (Required to Complete)

Firescreen

| | | | | | | | | |
|------------|--|-------|--------|----|----|----|----|---|
| FS-MI35-BK | Firescreen 35" screen front - Black | HNG 3 | \$ 439 | Y | Y | Y | Y | Y |
| FS-MI35-GM | Firescreen 35" screen front - Gun Metal | HNG 3 | \$ 469 | 14 | 14 | 14 | 14 | Y |
| FS-MI35-NB | Firescreen 35" screen front - New Bronze | HNG 3 | \$ 469 | Y | 14 | Y | 14 | Y |

Halston Arch

| | | | | | | | | |
|--------------|--|-------|--------|----|----|----|----|---|
| HARC-MI35-BK | Halston arched 35"screen front - Black | HNG 3 | \$ 819 | Y | Y | Y | 14 | Y |
| HARC-MI35-NB | Halston arched 35" screen front - New Bronze | HNG 3 | \$ 859 | Y | 14 | Y | 14 | Y |
| HARC-MI35-GM | Halston arched 35" screen front - Gun Metal | HNG 3 | \$ 859 | 14 | 14 | 14 | 14 | Y |

Inside Fit

| | | | | | | | | |
|-------------|-------------------------------------|-------|--------|---|---|----|----|---|
| INFIT-35-BK | Inside fit 35" screen front - Black | HTI 3 | \$ 399 | Y | Y | 14 | 14 | Y |
|-------------|-------------------------------------|-------|--------|---|---|----|----|---|

Iron Age

| | | | | | | | | |
|------------|--|-------|--------|----|----|----|----|---|
| IA-MI35-BK | Iron Age 35" screen front - Black | HNG 3 | \$ 669 | 14 | Y | 14 | 14 | Y |
| IA-MI35-NB | Iron Age 35" screen front - New Bronze | HNG 3 | \$ 709 | Y | 14 | 14 | 14 | Y |
| IA-MI35-GM | Iron Age 35" screen front - Gun Metal | HNG 3 | \$ 709 | 14 | 14 | 14 | 14 | Y |



Firescreen



Halston Arch



Inside Fit



Iron Age

Metal Surrounds (Required to Complete)**Surrounds - Small**

| | | | | | | | | |
|--------------|---|-------|--------|----|----|----|----|---|
| MI35-4229-BK | Small 35" surround 42" x 29" - Black | HTI 3 | \$ 409 | Y | Y | Y | Y | Y |
| MI35-4229-NB | Small 35" surround 42" x 29" - New Bronze | HTI 3 | \$ 439 | Y | 14 | Y | 14 | Y |
| MI35-4229-GM | Small 35" surround 42" x 29" - Gun Metal | HNG 3 | \$ 439 | 14 | 14 | 14 | 14 | Y |

Surrounds - Medium

| | | | | | | | | |
|---------------|---|-------|--------|----|----|----|----|---|
| MI35-4432D-BK | Medium 35" surround 44" x 32" x 2" deep - Black | HTI 3 | \$ 429 | 14 | 14 | Y | 14 | Y |
| MI35-4432-BK | Medium 35" surround 44" x 32" - Black | HTI 3 | \$ 429 | Y | Y | Y | Y | Y |
| MI35-4432-NB | Medium 35" surround 44" x 32" - New Bronze | HTI 3 | \$ 469 | 14 | 14 | Y | 14 | Y |
| MI35-4432-GM | Medium 35" surround 44" x 32" - Gun Metal | HNG 3 | \$ 469 | 14 | 14 | 14 | 14 | Y |

Surrounds - Large

| | | | | | | | | |
|--------------|---|-------|--------|----|----|----|----|---|
| MI35-4832-BK | Large 35" surround 48" x 32" - Black | HTI 3 | \$ 459 | Y | Y | Y | 14 | Y |
| MI35-4832-GM | Large 35" surround 48" x 32" - Gun Metal | HNG 3 | \$ 489 | 14 | 14 | 14 | 14 | Y |
| MI35-4832-NB | Large 35" surround 48" x 32" - New Bronze | HTI 3 | \$ 489 | 14 | 14 | 14 | 14 | Y |

Custom Surround

| | | | | | | | | |
|----------------|---|-------|--------|----|----|----|----|---|
| MI-USBC-RELO | Relocation kit for USB-C and reset switch from surround to under the front. For use when using inside fit or onsite surround. | HTI 3 | \$ 37 | Y | Y | Y | 14 | Y |
| MI35-5040CS-BK | On site 35" customizable surround - 50" w x 40" h (comes 4 sided with a 5" bottom, can be trimmed to make 3 sided) | HTI 3 | \$ 509 | Y | Y | Y | Y | Y |
| CUST-SRND-MI | Custom surround metal inserts (see custom surround order form for details) | HTI 3 | \$ 859 | 14 | 14 | 21 | 14 | Y |

Venting (Required to Complete)**Gas Insert Venting - 30/30 Termination Kits**

| | | | | | | | | |
|----------------|--|-------|--------|---|---|----|----|---|
| LINK-DV4-30B | Direct vent insert kit - one 4 - liner, one 30 - liner, plus term cap components | HTI 1 | \$ 549 | Y | Y | Y | Y | Y |
| LINK-DV30B | Direct vent insert kit - two 30 - liners, plus term cap components | HTI 1 | \$ 649 | Y | Y | Y | Y | Y |
| LINKSQB-DV4-30 | Direct vent insert kit - one 4 - liner, one 30 - liner, plus black term cap components | HTI 1 | \$ 649 | Y | Y | 14 | 14 | Y |
| LINKSQB-DV30 | Direct vent insert kit - two 30 - liners, plus black term cap components | HTI 1 | \$ 729 | Y | Y | Y | 14 | Y |
| LINKSQC-DV30 | Direct vent insert kit - two 30" liners, plus faux copper term cap components | HTI 1 | \$ 789 | Y | Y | Y | 14 | Y |

Gas Insert Venting - Components

| | | | | | | | | |
|--------------|---|-------|-------|---|---|----|----|---|
| LINK-ZC-ADPB | 14 1/2" round flashing adapter kit (for use with existing liner kits when using Class A pipe) | HTI 1 | \$ 90 | Y | Y | 14 | 14 | Y |
|--------------|---|-------|-------|---|---|----|----|---|

Conversion Kit**Conversion Kit**

| | | | | | | | | |
|------------|---|-------|------|--|---|---|---|---|
| LPK-MI-IFT | LP conversion kit for metal insert with IntelliFire Touch | HTI 3 | \$ 0 | | Y | Y | Y | Y |
|------------|---|-------|------|--|---|---|---|---|

Lighting**Accent Light Kit**

| | | | | | | | | |
|--------|---|-------|--------|---|---|---|----|---|
| MI-ALK | Ambient Light Kit (not for use in 25" models) (Not recommended for use with Reflective Black Glass Liner) | HTI 3 | \$ 499 | Y | Y | Y | 14 | Y |
|--------|---|-------|--------|---|---|---|----|---|

Liner Kit**Glass Liner**

| | | | | | | | | |
|-------------|--|-------|--------|---|---|---|----|---|
| LINER-BK-35 | Reflective Black Glass Liner 35" traditional units | HTI 3 | \$ 579 | Y | Y | Y | 14 | Y |
|-------------|--|-------|--------|---|---|---|----|---|

| Refractory Upgrade | | | | | | |
|---------------------------------|---|-------|----|-----|---|----|
| Fiber Refractory | | | | | | |
| BRICK-MI35-TR | Traditional 35" Brick interior panels - Stratford | HNG 3 | \$ | 309 | Y | Y |
| Fiber Refractory | | | | | | |
| BRICK-MI35-HB | Herringbone 35" Brick interior panels - Tranquil Greige | HNG 3 | \$ | 339 | Y | Y |
| Control, remotes, wall switches | | | | | | |
| Battery Back Up | | | | | | |
| BATTERY-WSK | Battery backup wall switch kit for units with IFT control systems. Includes: On/Off Wall Switch, USB-C Port, Battery Backup, Cover Plate, 12' Wire Harness | HTI 1 | \$ | 189 | Y | 14 |
| IntelliFire app | | | | | | |
| IFT-WFM | IntelliFire Wi-Fi Module that works with the IntelliFire iOS and Android app. Use to control all the features of your fireplace via a smart device. An RC400, RC450 or RC150 is required for thermostat control | HTI 1 | \$ | 229 | Y | Y |
| Touch Screen Remote | | | | | | |
| IFT-RC400 | IntelliFire Touch black remote control, docking station and auxiliary control module (on/off, flame height, thermostat mode, fan control, child lock, cold climate, timer mode, hot indicator, lights, on-screen maintenance and troubleshooting notifications) | HTI 1 | \$ | 389 | Y | Y |
| Wall Switch | | | | | | |
| IFT-RC150-HNG | IntelliFire Touch white wireless wall switch (on/off, cold climate, battery strength indicator) | HNG 1 | \$ | 121 | Y | Y |



Battery Back Up



IntelliFire app

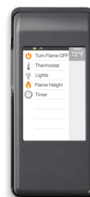

Touch Screen Remote



Wall Switch

Venting Notes
 Requires: LINK-DV30B, LINKSQB-DV30, LINKSQC-DV30, LINK-DV4-30B, LINKSQB-DV-30 or LINKSQC-DV4-30 flex liner kit. Refer to Venting section.

Hearth & Home Technologies

Gas Logs - Log Set Option

Stocked Item/Lead Time

004=Mt. Pleasant RDC
010=Kutztown RDC
014=Sacramento RDC
016=Charlotte RDC

EXP=Factory Expedite Program

Page printed 3/31/2025, 8:22:26 AM CDT
Current pricing updated 03/30/2025

Prices in USD

Non-stock and custom product cannot be cancelled.

* Please Contact Who You Purchase This Through for MSRP Pricing

Customer is responsible for freight for orders made outside of assigned RDC facility.

Campfire Gas Log Sets

Includes:

- Can operate with doors closed
- No visible controls
- Shut off valve
- Remote ready
- 18 & 24" - 10 fiber logs; 30" - 11 fiber log
- Glowing embers
- Flex connector
- Stainless steel burner
- Damper clamp
- Vermiculite
- CSA certified
- May not be operated in thermostat mode
- Remotes listed are for IPI controls only



No additional items required to complete.

| | | Disc. Code | MSRP USD | 004 IA | 010 PA | 014 CA | 016 NC | EXP |
|--------------|--|------------|----------|--------|--------|--------|--------|-----|
| CFL-18NG-C | 18" Campfire fiber gas log set with Stainless Steel Burner and hearth kit - 60,000 Btu/Hour Input (NG). | HTI 3 | \$ 1,039 | 14 | 14 | 14 | 14 | Y |
| CFL-18LP-C | 18" Campfire fiber gas log set with Stainless Steel Burner and hearth kit - 60,000 Btu/Hour Input (LP). | HTI 3 | \$ 1,039 | 14 | 14 | 14 | 14 | Y |
| CFL-24NG-C | 24" Campfire fiber gas log set with Stainless Steel Burner and hearth kit - 60,000 Btu/Hour Input (NG) | HTI 3 | \$ 1,109 | 14 | 14 | 14 | 14 | Y |
| CFL-24LP-C | 24" Campfire fiber gas log set with Stainless Steel Burner and hearth kit - 60,000 Btu/Hour Input (LP) | HTI 3 | \$ 1,109 | 14 | 14 | 14 | 14 | N |
| CFL-30LP-C | 30" Campfire fiber gas log set with Stainless Steel Burner and hearth kit - 60,000 Btu/Hour Input (LP) | HTI 3 | \$ 1,189 | 14 | 14 | 14 | 14 | N |
| CFL-30NG-C | 30" Campfire fiber gas log set with Stainless Steel Burner and hearth kit - 60,000 Btu/Hour Input (NG) | HTI 3 | \$ 1,189 | 14 | 14 | 14 | 14 | Y |
| CFL-24NG-IPI | 24" Campfire fiber gas log set with Stainless Steel Burner and hearth kit, IPI ignition - 60,000 Btu/Hour Input (NG) | HTI 3 | \$ 1,209 | 14 | 21 | 14 | 14 | Y |
| CFL-24LP-IPI | 24" Campfire fiber gas log set with Stainless Steel Burner and hearth kit, IPI ignition - 60,000 Btu/Hour Input (LP) | HTI 3 | \$ 1,209 | 14 | 21 | 14 | 14 | Y |

Control, remotes, wall switches

Millivolt/Standing Pilot Control, remotes, wall switches

| | | | | | | | | |
|-----|---|-------|--------|---|---|---|---|---|
| RCB | Hand-held On/Off with battery receiver and wall cover plates. | HTI 1 | \$ 189 | Y | Y | Y | Y | Y |
|-----|---|-------|--------|---|---|---|---|---|

Smart Stat Remote Control

| | | | | | | | | |
|----------------|--|-------|--------|---|---|---|---|---|
| SMART-STAT-HHT | Remote Control - IPI or SP (on/off, temp readout, thermostat mode, timer mode) | HTI 1 | \$ 289 | Y | Y | Y | Y | Y |
|----------------|--|-------|--------|---|---|---|---|---|

Fireside Grand Oak Gas Log Sets

Includes:

- Matchlight
- Steel grate
- Platinum embers
- Glowing embers
- Vermiculite
- Sand (except LP)
- Lava granules
- Damper clamp
- Shut off valve
- Flex connector
- May not be operated in thermostat mode
- Remotes listed are for IPI controls only
- Log set sold separately



Required to Complete - Sold Separately: • Log set

| | | Disc. Code | MSRP USD | 004 IA | 010 PA | 014 CA | 016 NC | EXP |
|-----------------|--|------------|----------|--------|--------|--------|--------|-----|
| GO24MTCH-HK | 24" Match Light Grand Oak Burner/Hearth Kit - 2 Tier | HTI 3 | \$ 1,029 | 21 | 21 | 14 | 21 | Y |
| GO30MTCH-HK | 30" Match Light Grand Oak Burner/Hearth Kit - 2 Tier | HTI 3 | \$ 1,029 | 21 | 14 | 14 | 21 | N |
| GO24-IPI-NG-HK | 24" IPI Grand Oak NG Burner/Hearth Kit - 2 Tier | HTI 3 | \$ 1,329 | Y | 14 | 14 | Y | Y |
| GO24-IPI-LP-HK | 24" IPI Grand Oak LP Burner/Hearth Kit - 2 Tier | HTI 3 | \$ 1,329 | Y | 21 | 21 | 21 | Y |
| GO30-IPI-NG-HK | 30" IPI Grand Oak NG Burner/Hearth Kit - 2 Tier | HTI 3 | \$ 1,369 | Y | 14 | 14 | 14 | N |
| GO30-IPI-LP-HK | 30" IPI Grand Oak LP Burner/Hearth Kit - 2 Tier | HTI 3 | \$ 1,369 | Y | 21 | 14 | 14 | Y |
| GO318-IPI-LP-HK | 18" IPI Grand Oak LP Burner/Hearth Kit - 3 Tier | HTI 3 | \$ 1,399 | 21 | 21 | 28 | 21 | Y |
| GO318-IPI-NG-HK | 18" IPI Grand Oak NG Burner/Hearth Kit - 3 Tier | HTI 3 | \$ 1,399 | 21 | 21 | 14 | 21 | Y |
| GO324-IPI-NG-HK | 24" IPI Grand Oak NG Burner/Hearth Kit - 3 Tier | HTI 3 | \$ 1,499 | Y | 14 | 14 | 14 | N |
| GO324-IPI-LP-HK | 24" IPI Grand Oak LP Burner/Hearth Kit - 3 Tier | HTI 3 | \$ 1,499 | 21 | 21 | 21 | 21 | Y |
| GO330-IPI-NG-HK | 30" IPI Grand Oak NG Burner/Hearth Kit - 3 Tier | HTI 3 | \$ 1,549 | Y | 21 | 21 | 14 | N |
| GO330-IPI-LP-HK | 30" IPI Grand Oak LP Burner/Hearth Kit - 3 Tier | HTI 3 | \$ 1,549 | Y | 21 | 14 | 14 | N |

Gas Logs - Log Set Option (Required to Complete)

Grand Oak Logs 24

| | | | | | | | | |
|------|---------------------------------------|-------|--------|----|---|----|----|---|
| GO24 | 24" Grand Oak Log Set - 11pcs, 2 Tier | HTI 3 | \$ 449 | 21 | Y | 14 | 14 | N |
|------|---------------------------------------|-------|--------|----|---|----|----|---|

Grand Oak Logs 24

| | | | | | | | | |
|------|---------------------------------------|-------|--------|----|----|----|----|---|
| GO30 | 30" Grand Oak Log Set - 12pcs, 2 Tier | HTI 3 | \$ 539 | 21 | 21 | 14 | 14 | N |
|------|---------------------------------------|-------|--------|----|----|----|----|---|

Grand Oak Logs 318

| | | | | | | | | |
|-------|---------------------------------------|-------|--------|---|----|----|----|---|
| GO318 | 18" Grand Oak Log Set - 10pcs, 3 Tier | HTI 3 | \$ 609 | Y | 21 | 14 | 21 | N |
|-------|---------------------------------------|-------|--------|---|----|----|----|---|

Grand Oak Logs 324

| | | | | | | | | |
|-------|---------------------------------------|-------|--------|----|----|----|---|---|
| GO324 | 24" Grand Oak Log Set - 11pcs, 3 Tier | HTI 3 | \$ 619 | 21 | 14 | 14 | Y | N |
|-------|---------------------------------------|-------|--------|----|----|----|---|---|

Grand Oak Logs 330

| | | | | | | | | |
|-------|---------------------------------------|-------|--------|---|----|----|----|---|
| GO330 | 30" Grand Oak Log Set - 12pcs, 3 Tier | HTI 3 | \$ 689 | Y | 21 | 14 | 14 | N |
|-------|---------------------------------------|-------|--------|---|----|----|----|---|

Control, remotes, wall switches

Millivolt/Standing Pilot Control, remotes, wall switches

| | | | | | | | | |
|-----|---|-------|--------|---|---|---|---|---|
| RCB | Hand-held On/Off with battery receiver and wall cover plates. | HTI 1 | \$ 189 | Y | Y | Y | Y | Y |
|-----|---|-------|--------|---|---|---|---|---|

Smart Stat Remote Control

| | | | | | | | | |
|----------------|--|-------|--------|---|---|---|---|---|
| SMART-STAT-HHT | Remote Control - IPI or SP (on/off, temp readout, thermostat mode, timer mode) | HTI 1 | \$ 289 | Y | Y | Y | Y | Y |
|----------------|--|-------|--------|---|---|---|---|---|

Fireside Grand Oak Outdoor Gas Log Sets

Includes:

- 3-step burner kit
- IPI Ignition
- Steel grate
- Lava granules
- Reinforced cement
- Damper clamp
- Shut off valve
- Flex connector
- Stainless steel burner/grate assembly
- Log set sold separately



Required to Complete - Sold Separately: • Log set

| | | Disc. Code | MSRP USD | 004 IA | 010 PA | 014 CA | 016 NC | EXP |
|-----------------|---|---------------|-------------|-----------|-----------|-----------|-----------|-----|
| OGO324-MTCH-HK | 24" Match Light Outdoor Grand Oaks Burner/Hearth Kit - 3 Tier (NG only) | HTI 3 | \$ 1,549 | 21 | 14 | 28 | 21 | Y |
| OGO324-IPING-HK | 24" IPI Outdoor Grand Oaks NG Burner/Hearth Kit - 3 Tier | HTI 3 | \$ 1,739 | Y | 21 | 14 | 21 | Y |
| OGO324-IPILP-HK | 24" IPI Outdoor Grand Oaks LP Burner/Hearth Kit - 3 Tier | HTI 3 | \$ 1,739 | 21 | 28 | 28 | 21 | Y |

Gas Logs - Log Set Option (Required to Complete)

Grand Oak Logs 324

| | | | | | | | | |
|-------|---------------------------------------|-------|--------|----|----|----|---|---|
| GO324 | 24" Grand Oak Log Set - 11pcs, 3 Tier | HTI 3 | \$ 619 | 21 | 14 | 14 | Y | N |
|-------|---------------------------------------|-------|--------|----|----|----|---|---|

Fireside Realwood Gas Log Sets

Includes:

- 8 refractory logs
- Reinforced cement



No additional items required to complete.

| | | Disc. Code | MSRP USD | 004 IA | 010 PA | 014 CA | 016 NC | EXP |
|--------|---|---------------|-------------|-----------|-----------|-----------|-----------|-----|
| FRW118 | 18" Fireside Realwood refractory cement log set (order hearth kit separately) | HTI 3 | \$ 199 | Y | 14 | Y | 14 | N |
| FRW124 | 24" Fireside Realwood refractory cement log set (order hearth kit separately) | HTI 3 | \$ 239 | 21 | 14 | Y | 21 | N |

Gas Logs - Burner Option Indoor (Required to Complete)

Match Light Hearth Kit

| | | | | | | | | |
|---------|--|-------|--------|---|----|----|----|---|
| MHK18NG | Hearth Kits Sand Pan Burners for Single-Sided Fireplaces 18" matchlight hearth kit - 60,000 Btu/Hour Input (NG only) | HTI 3 | \$ 279 | Y | 14 | Y | 14 | N |
| MHK24NG | Hearth Kits Sand Pan Burners for Single-Sided Fireplaces 24" matchlight hearth kit - 74,000 Btu/Hour Input (NG only) | HTI 3 | \$ 339 | Y | 14 | 21 | 21 | N |

Safety Pilot Hearth Kit

| | | | | | | | | |
|--------|---|-------|--------|----|----|----|----|---|
| SP18LP | Hearth Kits Sand Pan Burners for Single-Sided Fireplaces 18" safety pilot hearth kit - 40,000 Btu/Hour Input (LP) | HTI 3 | \$ 529 | 21 | 14 | 14 | 21 | N |
| SP18NG | Hearth Kits Sand Pan Burners for Single-Sided Fireplaces 18" safety pilot hearth kit - 60,000 Btu/Hour Input (NG) | HTI 3 | \$ 529 | Y | 14 | 14 | 14 | N |

Safety Pilot Hearth Kit

| | | | | | | | | |
|--------|---|-------|--------|---|----|----|----|---|
| SP24NG | Hearth Kits Sand Pan Burners for Single-Sided Fireplaces 24" safety pilot hearth kit - 67,000 Btu/Hour Input (NG) | HTI 3 | \$ 539 | Y | 14 | 14 | 21 | N |
| SP24LP | Hearth Kits Sand Pan Burners for Single-Sided Fireplaces 24" safety pilot hearth kit - 40,000 Btu/Hour Input (LP) | HTI 3 | \$ 539 | Y | 14 | 14 | 21 | N |

Remote Kits for SP Units

Gas Log Controls

| | | | | | | | | |
|---------|---|-------|--------|----|----|----|----|---|
| LMK-SP | Left side mounting kit - safety pilot | HTI 3 | \$ 84 | 14 | 21 | 14 | 21 | N |
| REM-KIT | On/off hi/low remote control and solenoid kit | HTI 3 | \$ 419 | Y | Y | 14 | Y | Y |

Fireside Supreme Oak Gas Logs

Includes:

- 12 refractory logs
- Reinforced cement



No additional items required to complete.

| | | Disc. Code | MSRP USD | 004 IA | 010 PA | 014 CA | 016 NC | EXP |
|-------|--|---------------|-------------|-----------|-----------|-----------|-----------|-----|
| FSO18 | 18" Fireside Supreme Oak refractory cement log set (order hearth kit separately) | HTI 3 | \$ 509 | Y | 14 | 14 | 21 | N |
| FSO24 | 24" Fireside Supreme Oak refractory cement log set (order hearth kit separately) | HTI 3 | \$ 549 | 21 | 14 | 21 | 21 | N |
| FSO30 | 30" Fireside Supreme Oak refractory cement log set (order hearth kit separately) | HTI 3 | \$ 589 | 21 | 14 | 14 | 21 | N |

Gas Logs - Burner Option Indoor (Required to Complete)**Match Light Hearth Kit**

| | | | | | | | | |
|---------|--|-------|--------|---|----|----|----|---|
| MHK18NG | Hearth Kits Sand Pan Burners for Single-Sided Fireplaces 18" matchlight hearth kit - 60,000 Btu/Hour Input (NG only) | HTI 3 | \$ 279 | Y | 14 | Y | 14 | N |
| MHK24NG | Hearth Kits Sand Pan Burners for Single-Sided Fireplaces 24" matchlight hearth kit - 74,000 Btu/Hour Input (NG only) | HTI 3 | \$ 339 | Y | 14 | 21 | 21 | N |

Safety Pilot Hearth Kit

| | | | | | | | | |
|--------|---|-------|--------|----|----|----|----|---|
| SP18LP | Hearth Kits Sand Pan Burners for Single-Sided Fireplaces 18" safety pilot hearth kit - 40,000 Btu/Hour Input (LP) | HTI 3 | \$ 529 | 21 | 14 | 14 | 21 | N |
| SP18NG | Hearth Kits Sand Pan Burners for Single-Sided Fireplaces 18" safety pilot hearth kit - 60,000 Btu/Hour Input (NG) | HTI 3 | \$ 529 | Y | 14 | 14 | 14 | N |

Safety Pilot Hearth Kit

| | | | | | | | | |
|--------|---|-------|--------|---|----|----|----|---|
| SP24NG | Hearth Kits Sand Pan Burners for Single-Sided Fireplaces 24" safety pilot hearth kit - 67,000 Btu/Hour Input (NG) | HTI 3 | \$ 539 | Y | 14 | 14 | 21 | N |
| SP24LP | Hearth Kits Sand Pan Burners for Single-Sided Fireplaces 24" safety pilot hearth kit - 40,000 Btu/Hour Input (LP) | HTI 3 | \$ 539 | Y | 14 | 14 | 21 | N |

Safety Pilot Hearth Kit

| | | | | | | | | |
|--------|--|-------|--------|----|----|----|----|---|
| SP30NG | 30" safety pilot hearth kit - 80,000 Btu/Hour Input (NG) | HTI 3 | \$ 559 | 21 | 21 | 21 | 21 | N |
| SP30LP | 30" safety pilot hearth kit - 60,000 Btu/Hour Input (LP) | HTI 3 | \$ 559 | 21 | 21 | 21 | 14 | N |

Remote Kits for SP Units**Gas Log Controls**

| | | | | | | | | |
|---------|---|-------|--------|----|----|----|----|---|
| LMK-SP | Left side mounting kit - safety pilot | HTI 3 | \$ 84 | 14 | 21 | 14 | 21 | N |
| REM-KIT | On/off hi/low remote control and solenoid kit | HTI 3 | \$ 419 | Y | Y | 14 | Y | Y |

Fireside Supreme Oak See-Through Gas Logs

Includes:

- 19 refractory logs
- Reinforced cement



No additional items required to complete.

| | | Disc. Code | MSRP USD | 004 IA | 010 PA | 014 CA | 016 NC | EXP |
|---------|--|---------------|-------------|-----------|-----------|-----------|-----------|-----|
| STFSO18 | 18" Fireside Supreme Oak gas log set for See-Through fireplace (order hearth kit separately) | HTI 3 | \$ 599 | 21 | 14 | 21 | 14 | N |
| STFSO24 | 24" Fireside Supreme Oak gas log set for See-Through fireplace (order hearth kit separately) | HTI 3 | \$ 619 | Y | 14 | 21 | 14 | N |

Gas Logs - Burner Option Indoor (Required to Complete)

See-Through Hearth Kit Safety Pilot

| | | | | | | | | |
|----------|---|-------|--------|----|----|----|----|---|
| STSP18LP | 18" safety pilot hearth kit for see-through fireplaces - 65,000 Btu/Hour Input (LP) | HTI 3 | \$ 829 | 21 | 14 | 21 | 14 | N |
| STSP18NG | 18" safety pilot hearth kit for see-through fireplaces - 60,000 Btu/Hour Input (NG) | HTI 3 | \$ 829 | 21 | 14 | 21 | 21 | N |

See-Through Hearth Kit Safety Pilot

| | | | | | | | | |
|----------|---|-------|--------|----|----|----|----|---|
| STSP24NG | 24" safety pilot hearth kit for see-through fireplaces - 75,000 Btu/Hour Input (NG) | HTI 3 | \$ 859 | 21 | 14 | 14 | 21 | N |
| STSP24LP | 24" safety pilot hearth kit for see-through fireplaces - 69,000 Btu/Hour Input (LP) | HTI 3 | \$ 859 | 21 | 14 | 21 | 14 | N |

Remote Kits for SP Units

Gas Log Controls

| | | | | | | | | |
|---------|---|-------|--------|----|----|----|----|---|
| LMK-SP | Left side mounting kit - safety pilot | HTI 3 | \$ 84 | 14 | 21 | 14 | 21 | N |
| REM-KIT | On/off hi/low remote control and solenoid kit | HTI 3 | \$ 419 | Y | Y | 14 | Y | Y |

Hearth & Home Technologies

Gas Logs - Burner Option Indoor

Stocked Item/Lead Time

004=Mt. Pleasant RDC
010=Kutztown RDC
014=Sacramento RDC
016=Charlotte RDC

EXP=Factory Expedite Program

Page printed 3/31/2025, 8:22:26 AM CDT
Current pricing updated 03/30/2025

Prices in USD

Non-stock and custom product cannot be cancelled.

* Please Contact Who You Purchase This Through for MSRP Pricing

Customer is responsible for freight for orders made outside of assigned RDC facility.

2-Tier Stadium - Vented Burner 18"

Includes:

- IPI - Battery Powered Electronic Ignition
- RCB On/Off Remote
- Black Steel Burner and Grate
- Glowing Embers
- Vermiculite
- Sand(NG only)
- Lava Rock
- Flex Connector
- Damper Clamp



Required to Complete - Sold Separately: • Select burner and logs to complete set

| | | Disc. Code | MSRP USD | 004 IA | 010 PA | 014 CA | 016 NC | EXP |
|---------------|--|------------|----------|--------|--------|--------|--------|-----|
| 2TR-IPI-R18-P | 2 Tier Stadium Vented Burner - 18" IPI Ignition w/Remote Propane | HTI 3 | \$ 1,409 | 21 | 14 | 14 | 14 | N |
| 2TR-IPI-R18-N | 2 Tier Stadium Vented Burner - 18" IPI Ignition w/Remote Natural Gas | HTI 3 | \$ 1,409 | Y | 14 | 14 | 14 | N |

Gas Logs - Log Set Option (Required to Complete)

2-Tier Grand Birch - Vented Gas Log Option

| | | | | | | | | |
|------------|---------------------------------------|-------|--------|----|----|----|----|---|
| 2TR-BRCH18 | 18" 2-Tier Grand Birch cement log set | HTI 3 | \$ 369 | 21 | 14 | 14 | 14 | N |
|------------|---------------------------------------|-------|--------|----|----|----|----|---|

2-Tier Grand Oaks - Vented Gas Log Option

| | | | | | | | | |
|----------|--------------------------------------|-------|--------|---|----|----|----|---|
| 2TR-GO18 | 18" 2-Tier Grand Oaks cement log set | HTI 3 | \$ 369 | Y | 14 | 14 | 14 | N |
|----------|--------------------------------------|-------|--------|---|----|----|----|---|

2-Tier Heritage Oak - Vented Gas Log Option

| | | | | | | | | |
|-----------|--|-------|--------|----|----|----|----|---|
| 2TR-OAK18 | 18" 2-Tier Heritage Oak cement log set | HTI 3 | \$ 369 | 21 | 14 | 14 | 14 | N |
|-----------|--|-------|--------|----|----|----|----|---|



2-Tier Grand Birch - Vented Gas Log Option

2-Tier Grand Oaks - Vented Gas Log Option

2-Tier Heritage Oak - Vented Gas Log Option

2-Tier Stadium - Vented Burner 24"

Includes:

- IPI - Battery Powered Electronic Ignition
- RCB On/Off Remote
- Black Steel Burner and Grate
- Glowing Embers
- Vermiculite
- Sand(NG only)
- Lava Rock
- Flex Connector
- Damper Clamp



Required to Complete - Sold Separately: • Select burner and logs to complete set

| | | Disc. Code | MSRP USD | 004 IA | 010 PA | 014 CA | 016 NC | EXP |
|---------------|--|------------|----------|--------|--------|--------|--------|-----|
| 2TR-IPI-R24-N | 2 Tier Stadium Vented Burner - 24" IPI Ignition w/Remote Natural Gas | HTI 3 | \$ 1,489 | Y | 14 | 14 | Y | N |
| 2TR-IPI-R24-P | 2 Tier Stadium Vented Burner - 24" IPI Ignition w/Remote Propane | HTI 3 | \$ 1,489 | Y | 14 | 14 | | N |

Gas Logs - Log Set Option (Required to Complete)

2-Tier Grand Birch - Vented Gas Log Option

| | | | | | | | | |
|------------|---------------------------------------|-------|--------|---|----|----|----|---|
| 2TR-BRCH24 | 24" 2-Tier Grand Birch cement log set | HTI 3 | \$ 449 | Y | 14 | 14 | 14 | N |
|------------|---------------------------------------|-------|--------|---|----|----|----|---|

2-Tier Grand Oaks - Vented Gas Log Option

| | | | | | | | | |
|----------|--------------------------------------|-------|--------|---|---|----|---|---|
| 2TR-GO24 | 24" 2-Tier Grand Oaks cement log set | HTI 3 | \$ 449 | Y | Y | 14 | Y | N |
|----------|--------------------------------------|-------|--------|---|---|----|---|---|

2-Tier Heritage Oak - Vented Gas Log Option

| | | | | | | | | |
|-----------|--|-------|--------|---|----|----|----|---|
| 2TR-OAK24 | 24" 2-Tier Heritage Oak cement log set | HTI 3 | \$ 449 | Y | 14 | 14 | 14 | N |
|-----------|--|-------|--------|---|----|----|----|---|



2-Tier Grand Birch - Vented Gas Log Option



2-Tier Grand Oaks - Vented Gas Log Option



2-Tier Heritage Oak - Vented Gas Log Option

2-Tier Stadium - Vented Burner 30"

Includes:

- IPI - Battery Powered Electronic Ignition
- RCB On/Off Remote
- Black Steel Burner and Grate
- Glowing Embers
- Vermiculite
- Sand(NG only)
- Lava Rock
- Flex Connector
- Damper Clamp



Required to Complete - Sold Separately: • Select burner and logs to complete set

| | | Disc. Code | MSRP USD | 004 IA | 010 PA | 014 CA | 016 NC | EXP |
|---------------|--|------------|----------|--------|--------|--------|--------|-----|
| 2TR-IPI-R30-P | 2 Tier Stadium Vented Burner - 30" IPI Ignition w/Remote Propane | HTI 3 | \$ 1,539 | Y | 14 | 14 | 14 | N |
| 2TR-IPI-R30-N | 2 Tier Stadium Vented Burner - 30" IPI Ignition w/Remote Natural Gas | HTI 3 | \$ 1,539 | Y | 14 | 14 | 14 | N |

Gas Logs - Log Set Option (Required to Complete)

2-Tier Grand Birch - Vented Gas Log Option

| | | | | | | | | |
|------------|---------------------------------------|-------|--------|---|----|----|----|---|
| 2TR-BRCH30 | 30" 2-Tier Grand Birch cement log set | HTI 3 | \$ 539 | Y | 14 | 14 | 14 | N |
|------------|---------------------------------------|-------|--------|---|----|----|----|---|

2-Tier Grand Oaks - Vented Gas Log Option

| | | | | | | | | |
|----------|--------------------------------------|-------|--------|---|----|----|---|---|
| 2TR-GO30 | 30" 2-Tier Grand Oaks cement log set | HTI 3 | \$ 539 | Y | 14 | 14 | Y | N |
|----------|--------------------------------------|-------|--------|---|----|----|---|---|

2-Tier Heritage Oak - Vented Gas Log Option

| | | | | | | | | |
|-----------|--|-------|--------|---|----|----|----|---|
| 2TR-OAK30 | 30" 2-Tier Heritage Oak cement log set | HTI 3 | \$ 539 | Y | 14 | 14 | 14 | N |
|-----------|--|-------|--------|---|----|----|----|---|



2-Tier Grand Birch - Vented Gas Log Option



2-Tier Grand Oaks - Vented Gas Log Option



2-Tier Heritage Oak - Vented Gas Log Option

3-Tier Stadium - Vented Burner 18"

Includes:

- IPI - Battery Powered Electronic Ignition
- RCB On/Off Remote
- Black Steel Burner and Grate
- Glowing Embers
- Vermiculite
- Sand(NG only)
- Lava Rock
- Flex Connector
- Damper Clamp



Required to Complete - Sold Separately: • Select burner and logs to complete set

| | | Disc. Code | MSRP USD | 004 IA | 010 PA | 014 CA | 016 NC | EXP |
|---------------|---|------------|----------|--------|--------|--------|--------|-----|
| 3TR-IPI-R18-P | 3 Tier Stadium Vented Burner - 18" IPI w/Remote Propane | HTI 3 | \$ 1,559 | 21 | 14 | 14 | 14 | N |
| 3TR-IPI-R18-N | 3 Tier Stadium Vented Burner - 18" IPI w/Remote Natural Gas | HTI 3 | \$ 1,559 | Y | 14 | 14 | 14 | N |

Gas Logs - Log Set Option (Required to Complete)

3-Tier Grand Birch - Vented Gas Log Option

| | | | | | | | | |
|------------|---------------------------------------|-------|--------|----|----|----|----|---|
| 3TR-BRCH18 | 18" 3-Tier Grand Birch cement log set | HTI 3 | \$ 609 | 21 | 14 | 14 | 14 | N |
|------------|---------------------------------------|-------|--------|----|----|----|----|---|

3-Tier Grand Oaks - Vented Gas Log Option

| | | | | | | | | |
|----------|--------------------------------------|-------|--------|---|----|----|----|---|
| 3TR-GO18 | 18" 3-Tier Grand Oaks cement log set | HTI 3 | \$ 609 | Y | 14 | 14 | 14 | N |
|----------|--------------------------------------|-------|--------|---|----|----|----|---|

3-Tier Heritage Oak - Vented Gas Log Option

| | | | | | | | | |
|-----------|--|-------|--------|----|----|----|----|---|
| 3TR-OAK18 | 18" 3-Tier Heritage Oak cement log set | HTI 3 | \$ 609 | 21 | 14 | 14 | 14 | N |
|-----------|--|-------|--------|----|----|----|----|---|



3-Tier Grand Birch - Vented Gas Log Option



3-Tier Grand Oaks - Vented Gas Log Option



3-Tier Heritage Oak - Vented Gas Log Option

3-Tier Stadium - Vented Burner 24"

Includes:

- IPI - Battery Powered Electronic Ignition
- RCB On/Off Remote
- Black Steel Burner and Grate
- Glowing Embers
- Vermiculite
- Sand(NG only)
- Lava Rock
- Flex Connector
- Damper Clamp



Required to Complete - Sold Separately: • Select burner and logs to complete set

| | | Disc. Code | MSRP USD | 004 IA | 010 PA | 014 CA | 016 NC | EXP |
|---------------|---|------------|----------|--------|--------|--------|--------|-----|
| 3TR-IPI-R24-P | 3 Tier Stadium Vented Burner - 24" IPI w/Remote Propane | HTI 3 | \$ 1,649 | | 14 | 14 | 14 | N |
| 3TR-IPI-R24-N | 3 Tier Stadium Vented Burner - 24" IPI w/Remote Natural Gas | HTI 3 | \$ 1,649 | Y | 14 | | Y | N |

Gas Logs - Log Set Option (Required to Complete)

3-Tier Grand Birch - Vented Gas Log Option

| | | | | | | | | |
|------------|---------------------------------------|-------|--------|---|----|----|----|---|
| 3TR-BRCH24 | 24" 3-Tier Grand Birch cement log set | HTI 3 | \$ 619 | Y | 14 | 14 | 14 | N |
|------------|---------------------------------------|-------|--------|---|----|----|----|---|

3-Tier Grand Oaks - Vented Gas Log Option

| | | | | | | | | |
|----------|--------------------------------------|-------|--------|---|----|----|---|---|
| 3TR-GO24 | 24" 3-Tier Grand Oaks cement log set | HTI 3 | \$ 619 | Y | 14 | 14 | Y | N |
|----------|--------------------------------------|-------|--------|---|----|----|---|---|

3-Tier Heritage Oak - Vented Gas Log Option

| | | | | | | | | |
|-----------|--|-------|--------|---|----|----|----|---|
| 3TR-OAK24 | 24" 3-Tier Heritage Oak cement log set | HTI 3 | \$ 619 | Y | 14 | 14 | 14 | N |
|-----------|--|-------|--------|---|----|----|----|---|



3-Tier Grand Birch - Vented Gas Log Option

3-Tier Grand Oaks - Vented Gas Log Option

3-Tier Heritage Oak - Vented Gas Log Option

3-Tier Stadium - Vented Burner 30"

Includes:

- IPI - Battery Powered Electronic Ignition
- RCB On/Off Remote
- Black Steel Burner and Grate
- Glowing Embers
- Vermiculite
- Sand(NG only)
- Lava Rock
- Flex Connector
- Damper Clamp



Required to Complete - Sold Separately: • Select burner and logs to complete set

| | | Disc. Code | MSRP USD | 004 IA | 010 PA | 014 CA | 016 NC | EXP |
|---------------|---------------------------|------------|----------|--------|--------|--------|--------|-----|
| 3TR-IPI-R30-N | 30* NG IPI 3TR HEARTH KIT | HTI 3 | \$ 1,699 | Y | 14 | 14 | 14 | N |
| 3TR-IPI-R30-P | 30* LP IPI 3TR HEARTH KIT | HTI 3 | \$ 1,699 | Y | 14 | 14 | 14 | N |

Gas Logs - Log Set Option (Required to Complete)

3-Tier Grand Birch - Vented Gas Log Option

| | | | | | | | | |
|------------|---------------------------------------|-------|--------|---|----|----|----|---|
| 3TR-BRCH30 | 30" 3-Tier Grand Birch cement log set | HTI 3 | \$ 689 | Y | 14 | 14 | 14 | N |
|------------|---------------------------------------|-------|--------|---|----|----|----|---|

3-Tier Grand Oaks - Vented Gas Log Option

| | | | | | | | | |
|----------|--------------------------------------|-------|--------|---|----|--|---|---|
| 3TR-GO30 | 30" 3-Tier Grand Oaks cement log set | HTI 3 | \$ 689 | Y | 14 | | Y | N |
|----------|--------------------------------------|-------|--------|---|----|--|---|---|

3-Tier Heritage Oak - Vented Gas Log Option

| | | | | | | | | |
|-----------|--|-------|--------|---|----|----|----|---|
| 3TR-OAK30 | 30" 3-Tier Heritage Oak cement log set | HTI 3 | \$ 689 | Y | 14 | 14 | 14 | N |
|-----------|--|-------|--------|---|----|----|----|---|



3-Tier Grand Birch - Vented Gas Log Option

3-Tier Grand Oaks - Vented Gas Log Option

3-Tier Heritage Oak - Vented Gas Log Option

Contemporary Vented Burner 24"

Includes:

- IPI - Battery Powered Electronic Ignition
- RCB On/Off Remote
- Black Steel Burner
- Lava Rock
- Flex Connector
- Damper Clamp



Required to Complete - Sold Separately: • 3 Bags of Media

| | | Disc. Code | MSRP USD | 004 IA | 010 PA | 014 CA | 016 NC | EXP |
|--------------|--|------------|----------|--------|--------|--------|--------|-----|
| CNTMPIPI24-P | Contemporary Vented Burner - 24" Propane | HTI 3 | \$ 679 | 21 | 14 | 14 | 14 | N |
| CNTMPIPI24-N | Contemporary Vented Burner - 24" Natural Gas | HTI 3 | \$ 679 | Y | 14 | 14 | 14 | N |

Media (Required to Complete)

Crushed Glass Media

| | | | | | | | | |
|----------|---|-------|-------|---|---|---|---|---|
| MEDIA-CP | Copper Embers - Crushed Glass Media (1 bag, 5lbs) | HTI 1 | \$ 77 | Y | Y | Y | Y | Y |
| MEDIA-CY | Crystal Embers - Crushed Glass Media (1 bag, 5lbs) | HTI 1 | \$ 77 | Y | Y | Y | Y | Y |
| MEDIA-GT | Graphite Embers - Crushed Glass Media (1 bag, 5lbs) | HTI 1 | \$ 77 | Y | Y | Y | Y | Y |
| MEDIA-SM | Smoked Embers - Crushed Glass Media (1 bag, 5lbs) | HTI 1 | \$ 77 | Y | Y | Y | Y | Y |

Cannonballs

| | | | | | | | | |
|-----------|-------------|-------|-------|----|----|----|----|---|
| CNNBLS-24 | Cannonballs | HTI 3 | \$ 85 | 21 | 14 | 14 | 14 | N |
|-----------|-------------|-------|-------|----|----|----|----|---|



Cannonballs

Contemporary Vented Burner 30"

Includes:

- IPI - Battery Powered Electronic Ignition
- RCB On/Off Remote
- Black Steel Burner
- Lava Rock
- Flex Connector
- Damper Clamp



Required to Complete - Sold Separately: • 4 Bags of Media

| | | Disc. Code | MSRP USD | 004 IA | 010 PA | 014 CA | 016 NC | EXP |
|--------------|--|------------|----------|--------|--------|--------|--------|-----|
| CNTMPIPI30-N | Contemporary Vented Burner - 30" Natural Gas | HTI 3 | \$ 819 | Y | 14 | 14 | 14 | N |
| CNTMPIPI30-P | Contemporary Vented Burner - 30" Propane | HTI 3 | \$ 819 | 21 | 14 | 14 | 14 | N |

Media (Required to Complete)

Crushed Glass Media

| | | | | | | | | |
|----------|---|-------|-------|---|---|---|---|---|
| MEDIA-CP | Copper Embers - Crushed Glass Media (1 bag, 5lbs) | HTI 1 | \$ 77 | Y | Y | Y | Y | Y |
| MEDIA-CY | Crystal Embers - Crushed Glass Media (1 bag, 5lbs) | HTI 1 | \$ 77 | Y | Y | Y | Y | Y |
| MEDIA-GT | Graphite Embers - Crushed Glass Media (1 bag, 5lbs) | HTI 1 | \$ 77 | Y | Y | Y | Y | Y |
| MEDIA-SM | Smoked Embers - Crushed Glass Media (1 bag, 5lbs) | HTI 1 | \$ 77 | Y | Y | Y | Y | Y |

Cannonballs

| | | | | | | | | |
|-----------|-------------|-------|--------|----|----|----|----|---|
| CNNBLS-30 | Cannonballs | HTI 3 | \$ 100 | 21 | 14 | 14 | 14 | N |
|-----------|-------------|-------|--------|----|----|----|----|---|



Cannonballs

Double Tube - Vented Burner 18"

Includes:

- Safety Pilot or IPI Electronic Ignition
- Safety Pilot SKUs include sylenoid with on/off high/low remote installed
- IPI SKUs include RCB On/Off Remote
- Glowing Embers
- Vermiculite
- Sand(NG only)
- Lava Rock
- Flex Connector
- Damper Clamp



Special Considerations:

- VTD-OAK18 includes both Timberland Oak and Smoldering Timberland Oak Logs

Required to Complete - Sold Separately: • Select burner and logs to complete set

| | | Disc. Code | MSRP USD | 004 IA | 010 PA | 014 CA | 016 NC | EXP |
|------------|---|------------|----------|--------|--------|--------|--------|-----|
| HTSP-R18-P | Double Tube Vented Burner - 18" Safety Pilot w/Remote Hi-Lo Propane | HTI 3 | \$ 869 | 21 | 14 | 14 | 14 | N |
| HTSP-R18-N | Double Tube Vented Burner - 18" Safety Pilot w/Remote Hi-Lo Natural Gas | HTI 3 | \$ 869 | Y | 14 | 14 | 14 | N |

Gas Logs - Log Set Option (Required to Complete)

Kindled Stack - Vented Gas Log Option

| | | | | | | | | |
|------------|----------------------------------|-------|--------|---|----|----|----|---|
| VTD-STCK18 | 18" Kindled Stack cement log set | HTI 3 | \$ 259 | Y | 14 | 14 | 14 | N |
|------------|----------------------------------|-------|--------|---|----|----|----|---|

Timberland Oak - Vented Gas Log Option

| | | | | | | | | |
|-----------|-----------------------------------|-------|--------|---|----|----|----|---|
| VTD-OAK18 | 18" Timberland Oak cement log set | HTI 3 | \$ 229 | Y | 14 | 14 | 14 | N |
|-----------|-----------------------------------|-------|--------|---|----|----|----|---|

Woodland Birch - Vented Gas Log Option

| | | | | | | | | |
|------------|-----------------------------------|-------|--------|---|----|----|----|---|
| VTD-BRCH18 | 18" Woodland Birch cement log set | HTI 3 | \$ 239 | Y | 14 | 14 | 14 | N |
|------------|-----------------------------------|-------|--------|---|----|----|----|---|



Kindled Stack - Vented Gas Log Option



Timberland Oak - Vented Gas Log Option



Woodland Birch - Vented Gas Log Option

Options & Accessories

Options & Accessories

| | | | | | | | | |
|--------|--------------------------------------|-------|--------|----|----|----|----|---|
| DV-RWA | Rock Wool, Carton of 12-4 oz. Bags.* | HTI 3 | \$ 200 | 35 | 35 | 35 | 35 | Y |
|--------|--------------------------------------|-------|--------|----|----|----|----|---|

Options & Accessories

| | | | | | | | | |
|---------|---|-------|--------|---|----|----|----|---|
| VR1000A | Volcanic Rock - Carton of 12 - 2 lb. Bags.* | HTI 3 | \$ 299 | 8 | 21 | 14 | 14 | Y |
|---------|---|-------|--------|---|----|----|----|---|

Double Tube - Vented Burner 24"

Includes:

- Safety Pilot or IPI Electronic Ignition
- Safety Pilot SKUs include sylenoid with on/off high/low remote installed
- IPI SKUs include RCB On/Off Remote
- Glowing Embers
- Vermiculite
- Sand(NG only)
- Lava Rock
- Flex Connector
- Damper Clamp



Special Considerations:

- VTD-OAK24 includes both Timberland Oak and Smoldering Timberland Oak Logs

Required to Complete - Sold Separately: • Select burner and logs to complete set

| | | Disc. Code | MSRP USD | 004 IA | 010 PA | 014 CA | 016 NC | EXP |
|----------------|---|------------|----------|--------|--------|--------|--------|-----|
| HTSP-R24-N | Double Tube Vented Burner - 24" Safety Pilot w/Remote Hi-Lo Natural Gas | HTI 3 | \$ 899 | Y | 14 | 14 | 14 | N |
| HTSP-R24-P | Double Tube Vented Burner - 24" Safety Pilot w/Remote Hi-Lo Propane | HTI 3 | \$ 899 | 21 | 14 | 14 | 14 | N |
| HTIPI-R18-24-P | Double Tube Vented Burner - 18/24" IPI w/Remote Propane | HTI 3 | \$ 1,259 | Y | 14 | 14 | 14 | N |
| HTIPI-R18-24-N | Double Tube Vented Burner - 18/24" IPI w/Remote Natural Gas | HTI 3 | \$ 1,259 | Y | 14 | 14 | 14 | N |

Gas Logs - Log Set Option (Required to Complete)

Kindled Stack - Vented Gas Log Option

| | | | | | | | | |
|------------|----------------------------------|-------|--------|---|----|----|----|---|
| VTD-STCK24 | 24" Kindled Stack cement log set | HTI 3 | \$ 319 | Y | 14 | 14 | 14 | N |
|------------|----------------------------------|-------|--------|---|----|----|----|---|

Timberland Oak - Vented Gas Log Option

| | | | | | | | | |
|-----------|-----------------------------------|-------|--------|---|----|----|----|---|
| VTD-OAK24 | 24" Timberland Oak cement log set | HTI 3 | \$ 289 | Y | 14 | 14 | 14 | N |
|-----------|-----------------------------------|-------|--------|---|----|----|----|---|

Woodland Birch - Vented Gas Log Option

| | | | | | | | | |
|------------|-----------------------------------|-------|--------|---|----|----|----|---|
| VTD-BRCH24 | 24" Woodland Birch cement log set | HTI 3 | \$ 299 | Y | 14 | 14 | 14 | N |
|------------|-----------------------------------|-------|--------|---|----|----|----|---|



Kindled Stack - Vented Gas Log Option



Timberland Oak - Vented Gas Log Option



Woodland Birch - Vented Gas Log Option

Options & Accessories

Options & Accessories

| | | | | | | | | |
|--------|--------------------------------------|-------|--------|----|----|----|----|---|
| DV-RWA | Rock Wool, Carton of 12-4 oz. Bags.* | HTI 3 | \$ 200 | 35 | 35 | 35 | 35 | Y |
|--------|--------------------------------------|-------|--------|----|----|----|----|---|

Options & Accessories

| | | | | | | | | |
|---------|---|-------|--------|---|----|----|----|---|
| VR1000A | Volcanic Rock - Carton of 12 - 2 lb. Bags.* | HTI 3 | \$ 299 | 8 | 21 | 14 | 14 | Y |
|---------|---|-------|--------|---|----|----|----|---|

Double Tube - Vented Burner 30"

Includes:

- Safety Pilot or IPI Electronic Ignition
- Safety Pilot SKUs include sylenoid with on/off high/low remote installed
- IPI SKUs include RCB On/Off Remote
- Glowing Embers
- Vermiculite
- Sand(NG only)
- Lava Rock
- Flex Connector
- Damper Clamp



Special Considerations:

- For Timberland Oak, order VTD-OAK30 and VTD-OKEK

Required to Complete - Sold Separately: • Select burner and logs to complete set

| | | Disc. Code | MSRP USD | 004 IA | 010 PA | 014 CA | 016 NC | EXP |
|-------------|---|------------|----------|--------|--------|--------|--------|-----|
| HTSP-R30-N | Double Tube Vented Burner - 30" Safety Pilot w/Remote Hi-Lo Natural Gas | HTI 3 | \$ 919 | 21 | 14 | 14 | 14 | N |
| HTSP-R30-P | Double Tube Vented Burner - 30" Safety Pilot w/Remote Hi-Lo Propane | HTI 3 | \$ 919 | 21 | 14 | 14 | 14 | N |
| HTIPI-R30-P | Double Tube Vented Burner - 30" IPI w/Remote Propane | HTI 3 | \$ 1,439 | 21 | 14 | 14 | 14 | N |
| HTIPI-R30-N | Double Tube Vented Burner - 30" IPI w/Remote Natural Gas | HTI 3 | \$ 1,439 | 21 | 14 | 14 | 14 | N |

Gas Logs - Log Set Option (Required to Complete)

Kindled Stack - Vented Gas Log Option

| | | | | | | | | |
|------------|----------------------------------|-------|--------|----|----|----|----|---|
| VTD-STCK30 | 30" Kindled Stack cement log set | HTI 3 | \$ 369 | 21 | 14 | 14 | 14 | N |
|------------|----------------------------------|-------|--------|----|----|----|----|---|

Timberland Oak - Vented Gas Log Option

| | | | | | | | | |
|-----------|---|-------|--------|----|----|----|----|---|
| VTD-OKEK | Enhancement Kit for Timberland Oak set. | HTI 3 | \$ 49 | 21 | 14 | 14 | 14 | Y |
| VTD-OAK30 | 30" Timberland Oak cement log set | HTI 3 | \$ 339 | 21 | 14 | 14 | 14 | N |

Woodland Birch - Vented Gas Log Option

| | | | | | | | | |
|------------|-----------------------------------|-------|--------|----|----|----|----|---|
| VTD-BRCH30 | 30" Woodland Birch cement log set | HTI 3 | \$ 349 | 21 | 14 | 14 | 14 | N |
|------------|-----------------------------------|-------|--------|----|----|----|----|---|



Kindled Stack - Vented Gas Log Option



Timberland Oak - Vented Gas Log Option



Woodland Birch - Vented Gas Log Option

Options & Accessories

Options & Accessories

| | | | | | | | | |
|--------|--------------------------------------|-------|--------|----|----|----|----|---|
| DV-RWA | Rock Wool, Carton of 12-4 oz. Bags.* | HTI 3 | \$ 200 | 35 | 35 | 35 | 35 | Y |
|--------|--------------------------------------|-------|--------|----|----|----|----|---|

Options & Accessories

| | | | | | | | | |
|---------|---|-------|--------|---|----|----|----|---|
| VR1000A | Volcanic Rock - Carton of 12 - 2 lb. Bags.* | HTI 3 | \$ 299 | 8 | 21 | 14 | 14 | Y |
|---------|---|-------|--------|---|----|----|----|---|

Fireside Realwood Outdoor Gas Log Sets

Includes:

- 62,000 Btu/Hr Input NG
- Match Light (NG), Safety Pilot (LP)
- Pan burner kit
- Stainless steel grate
- Lava rock
- Damper clamp
- Flex connector
- Shut off valve



Required to Complete - Sold Separately: • Fireside Realwood log set (FRW118 or FRW124) required to complete.

| | | Disc. Code | MSRP USD | 004 IA | 010 PA | 014 CA | 016 NC | EXP |
|-----------|--|------------|----------|--------|--------|--------|--------|-----|
| OD-18NG | 18" matchlight hearth kit for outdoor fireplaces - 62,000 Btu/Hour Input (NG only) | HTI 3 | \$ 889 | 21 | 21 | 21 | 21 | N |
| ODSP-18LP | 18" safety pilot hearth kit for outdoor fireplaces - 55,000 Btu/Hour Input LP (Note: Controls are located on the right and may offset the unit in the fireplace. Choose hearth size accordingly. See installation manual for hearth dimensions.) | HTI 3 | \$ 1,019 | 21 | 21 | 21 | 21 | N |
| OD-24NG | 24" matchlight hearth kit for outdoor fireplaces - 69,000 Btu/Hour Input (NG only) | HTI 3 | \$ 1,059 | 21 | 21 | 21 | 21 | N |
| ODSP-24LP | 24" safety pilot hearth kit for outdoor fireplaces - 61,000 Btu/Hour input LP (Note: Controls are located on the right and may offset the unit in the fireplace. Choose hearth size accordingly. See installation manual for hearth dimensions.) | HTI 3 | \$ 1,139 | 21 | 21 | 21 | 21 | N |

Gas Logs - Log Set Option (Required to Complete)

Fireside Realwood Gas Log Sets

| | | | | | | | | |
|--------|---|-------|--------|----|----|---|----|---|
| FRW118 | 18" Fireside Realwood refractory cement log set (order hearth kit separately) | HTI 3 | \$ 199 | Y | 14 | Y | 14 | N |
| FRW124 | 24" Fireside Realwood refractory cement log set (order hearth kit separately) | HTI 3 | \$ 239 | 21 | 14 | Y | 21 | N |



Fireside Realwood Gas Log Sets

Remote Kits for SP Units

Gas Log Controls

| | | | | | | | | |
|--------|---------------------------------------|-------|-------|----|----|----|----|---|
| LMK-SP | Left side mounting kit - safety pilot | HTI 3 | \$ 84 | 14 | 21 | 14 | 21 | N |
|--------|---------------------------------------|-------|-------|----|----|----|----|---|

Radiant Burner 18/24"

Includes:

- Up to 17,000 BTUs of radiant heat
- RCB Remote sent standard
- IPI Electronic Ignition - Battery powered
- Lava Rock & Wool Embers
- Stainless Steel Burner Pan
- Factory Installed Grate
- Damper Clamp
- On/Off Switch



Required to Complete - Sold Separately: • Please select desired log option

| | | Disc. Code | MSRP USD | 004 IA | 010 PA | 014 CA | 016 NC | EXP |
|------------|--|------------|----------|--------|--------|--------|--------|-----|
| RB-18-24NI | 18"/24" Radiant Vented Burner Assembly IPI w/remote N.G. 50,000 BTUs | HTI 3 | \$ 1,479 | Y | Y | 14 | Y | Y |
| RB-18-24PI | 18"/24" Radiant Vented Burner Assembly IPI w/remote L.P. 50,000 BTUs | HTI 3 | \$ 1,479 | Y | Y | 14 | Y | Y |

Gas Logs - Log Set Option (Required to Complete)

DUZY2 Logs

| | | | | | | | | |
|---------------|--|-------|--------|---|---|----|---|---|
| DUZY2LS-18-24 | 4-piece Fiber Ceramic log set for use with 18/24" Radiant Burner | HTI 3 | \$ 359 | Y | Y | 14 | Y | Y |
|---------------|--|-------|--------|---|---|----|---|---|

DUZY3 Logs

| | | | | | | | | |
|---------------|--|-------|--------|---|---|----|---|---|
| DUZY3LS-18-24 | 6-piece Refractory Cement log set for use with 18/24" Radiant Burner | HTI 3 | \$ 429 | Y | Y | 14 | Y | N |
|---------------|--|-------|--------|---|---|----|---|---|

DUZY5 Logs

| | | | | | | | | |
|---------------|--|-------|--------|---|---|----|---|---|
| DUZY5LS-18-24 | 8-piece Fiber Ceramic log set for use with 18/24" Radiant Burner | HTI 3 | \$ 489 | Y | Y | 14 | Y | Y |
|---------------|--|-------|--------|---|---|----|---|---|



DUZY2 Logs



DUZY3 Logs



DUZY5 Logs

Options & Accessories

Options & Accessories

| | | | | | | | | |
|--------|--------------------------------------|-------|--------|----|----|----|----|---|
| DV-RWA | Rock Wool, Carton of 12-4 oz. Bags.* | HTI 3 | \$ 200 | 35 | 35 | 35 | 35 | Y |
|--------|--------------------------------------|-------|--------|----|----|----|----|---|

Options & Accessories

| | | | | | | | | |
|---------|---|-------|--------|---|----|----|----|---|
| VR1000A | Volcanic Rock - Carton of 12 - 2 lb. Bags.* | HTI 3 | \$ 299 | 8 | 21 | 14 | 14 | Y |
|---------|---|-------|--------|---|----|----|----|---|

Control, remotes, wall switches

Millivolt/Standing Pilot Control, remotes, wall switches

| | | | | | | | | |
|------|--|-------|-------|---|----|----|----|---|
| RRCM | Remote receiver cover, insulated metal | HTI 1 | \$ 31 | Y | 21 | 21 | 21 | Y |
|------|--|-------|-------|---|----|----|----|---|

Radiant Burner 30"

Includes:

- Up to 17,000 BTUs of radiant heat
- RCB Remote sent standard
- IPI Electronic Ignition - battery powered
- Lava Rock & Wool Embers
- Stainless Steel Burner Pan
- Factory Installed Grate
- Damper Clamp
- On/Off Switch



Required to Complete - Sold Separately: • Please select desired log option

| | | Disc. Code | MSRP USD | 004 IA | 010 PA | 014 CA | 016 NC | EXP |
|---------|--|------------|----------|--------|--------|--------|--------|-----|
| RB-30NI | 30" Radiant Vented Burner Assembly IPI w/remote N.G. 65,000 BTUs | HTI 3 | \$ 1,569 | Y | Y | 14 | Y | Y |
| RB-30PI | 30" Radiant Vented Burner Assembly IPI w/remote L.P. 65,000 BTUs | HTI 3 | \$ 1,569 | Y | 14 | 14 | 14 | Y |

Gas Logs - Log Set Option

DUZY2 Logs

| | | | | | | | | |
|------------|---|-------|--------|---|----|----|----|---|
| DUZY2LS-30 | 4-piece Fiber Ceramic log set for use with 30" Radiant Burner | HTI 3 | \$ 429 | 8 | 14 | 14 | 14 | Y |
|------------|---|-------|--------|---|----|----|----|---|

DUZY3 Logs

| | | | | | | | | |
|------------|---|-------|--------|---|----|----|----|---|
| DUZY3LS-30 | 6-piece Refractory Cement log set for use with 30" Radiant Burner | HTI 3 | \$ 489 | Y | 14 | 14 | 14 | N |
|------------|---|-------|--------|---|----|----|----|---|

DUZY5 Logs

| | | | | | | | | |
|------------|---|-------|--------|---|----|----|----|---|
| DUZY5LS-30 | 8-piece Fiber Ceramic log set for use with 30" Radiant Burner | HTI 3 | \$ 599 | 8 | 14 | 14 | 14 | Y |
|------------|---|-------|--------|---|----|----|----|---|



DUZY2 Logs



DUZY3 Logs



DUZY5 Logs

Options & Accessories

Options & Accessories

| | | | | | | | | |
|--------|--------------------------------------|-------|--------|----|----|----|----|---|
| DV-RWA | Rock Wool, Carton of 12-4 oz. Bags.* | HTI 3 | \$ 200 | 35 | 35 | 35 | 35 | Y |
|--------|--------------------------------------|-------|--------|----|----|----|----|---|

Options & Accessories

| | | | | | | | | |
|---------|---|-------|--------|---|----|----|----|---|
| VR1000A | Volcanic Rock - Carton of 12 - 2 lb. Bags.* | HTI 3 | \$ 299 | 8 | 21 | 14 | 14 | Y |
|---------|---|-------|--------|---|----|----|----|---|

Control, remotes, wall switches

Millivolt/Standing Pilot Control, remotes, wall switches

| | | | | | | | | |
|------|--|-------|-------|---|----|----|----|---|
| RRCM | Remote receiver cover, insulated metal | HTI 1 | \$ 31 | Y | 21 | 21 | 21 | Y |
|------|--|-------|-------|---|----|----|----|---|

Single Tube - Vented Burner 18"

Includes:

- Match Light or Safety Pilot Ignition
- Glowing Embers
- Vermiculite
- Sand(NG only)
- Lava Rock
- Flex Connector
- Damper Clamp



Special Considerations:

- VTD-OAK18 includes both Timberland Oak and Smoldering Timberland Oak Logs

Required to Complete - Sold Separately: • Select burner and logs to complete set

| | | Disc. Code | MSRP USD | 004 IA | 010 PA | 014 CA | 016 NC | EXP |
|----------|---|------------|----------|--------|--------|--------|--------|-----|
| STM18-N | Single Tube Vented Burner - 18" Manual Ignition Natural Gas | HTI 3 | \$ 279 | Y | 14 | 14 | 14 | N |
| STSP18-P | Single Tube Vented Burner - 18" Safety Pilot Ignition Propane | HTI 3 | \$ 519 | 21 | 14 | 14 | 14 | N |
| STSP18-N | Single Tube Vented Burner - 18" Safety Pilot Ignition Natural Gas | HTI 3 | \$ 519 | Y | 14 | 14 | 14 | N |

Gas Logs - Log Set Option (Required to Complete)

Kindled Stack - Vented Gas Log Option

| | | | | | | | | |
|------------|----------------------------------|-------|--------|---|----|----|----|---|
| VTD-STCK18 | 18" Kindled Stack cement log set | HTI 3 | \$ 259 | Y | 14 | 14 | 14 | N |
|------------|----------------------------------|-------|--------|---|----|----|----|---|

Timberland Oak - Vented Gas Log Option

| | | | | | | | | |
|-----------|-----------------------------------|-------|--------|---|----|----|----|---|
| VTD-OAK18 | 18" Timberland Oak cement log set | HTI 3 | \$ 229 | Y | 14 | 14 | 14 | N |
|-----------|-----------------------------------|-------|--------|---|----|----|----|---|

Woodland Birch - Vented Gas Log Option

| | | | | | | | | |
|------------|-----------------------------------|-------|--------|---|----|----|----|---|
| VTD-BRCH18 | 18" Woodland Birch cement log set | HTI 3 | \$ 239 | Y | 14 | 14 | 14 | N |
|------------|-----------------------------------|-------|--------|---|----|----|----|---|



Kindled Stack - Vented Gas Log Option



Timberland Oak - Vented Gas Log Option



Woodland Birch - Vented Gas Log Option

Options & Accessories

Options & Accessories

| | | | | | | | | |
|--------|--------------------------------------|-------|--------|----|----|----|----|---|
| DV-RWA | Rock Wool, Carton of 12-4 oz. Bags.* | HTI 3 | \$ 200 | 35 | 35 | 35 | 35 | Y |
|--------|--------------------------------------|-------|--------|----|----|----|----|---|

Options & Accessories

| | | | | | | | | |
|---------|---|-------|--------|---|----|----|----|---|
| VR1000A | Volcanic Rock - Carton of 12 - 2 lb. Bags.* | HTI 3 | \$ 299 | 8 | 21 | 14 | 14 | Y |
|---------|---|-------|--------|---|----|----|----|---|

Remote Kits for SP Units

Gas Log Controls

| | | | | | | | | | |
|---------|---|-------|----|-----|----|----|----|----|---|
| LMK-SP | Left side mounting kit - safety pilot | HTI 3 | \$ | 84 | 14 | 21 | 14 | 21 | N |
| REM-KIT | On/off hi/low remote control and solenoid kit | HTI 3 | \$ | 419 | Y | Y | 14 | Y | Y |

Single Tube - Vented Burner 24"

Includes:

- Match Light or Safety Pilot Ignition
- Glowing Embers
- Vermiculite
- Sand(NG only)
- Lava Rock
- Flex Connector
- Damper Clamp



Special Considerations:

- VTD-OAK24 includes both Timberland Oak and Smoldering Timberland Oak Logs

Required to Complete - Sold Separately: • Select burner and logs to complete set

| | | Disc. Code | MSRP USD | 004 IA | 010 PA | 014 CA | 016 NC | EXP |
|----------|---|------------|----------|--------|--------|--------|--------|-----|
| STM24-N | Single Tube Vented Burner - 24" Manual Ignition Natural Gas | HTI 3 | \$ 339 | Y | 14 | Y | 14 | N |
| STSP24-N | Single Tube Vented Burner - 24" Safety Pilot Ignition Natural Gas | HTI 3 | \$ 529 | | 14 | 14 | Y | N |
| STSP24-P | Single Tube Vented Burner - 24" Safety Pilot Ignition Propane | HTI 3 | \$ 529 | | 14 | 14 | 14 | N |

Gas Logs - Log Set Option (Required to Complete)

Kindled Stack - Vented Gas Log Option

| | | | | | | | | |
|------------|----------------------------------|-------|--------|---|----|----|----|---|
| VTD-STCK24 | 24" Kindled Stack cement log set | HTI 3 | \$ 319 | Y | 14 | 14 | 14 | N |
|------------|----------------------------------|-------|--------|---|----|----|----|---|

Timberland Oak - Vented Gas Log Option

| | | | | | | | | |
|-----------|-----------------------------------|-------|--------|---|----|----|----|---|
| VTD-OAK24 | 24" Timberland Oak cement log set | HTI 3 | \$ 289 | Y | 14 | 14 | 14 | N |
|-----------|-----------------------------------|-------|--------|---|----|----|----|---|

Woodland Birch - Vented Gas Log Option

| | | | | | | | | |
|------------|-----------------------------------|-------|--------|---|----|----|----|---|
| VTD-BRCH24 | 24" Woodland Birch cement log set | HTI 3 | \$ 299 | Y | 14 | 14 | 14 | N |
|------------|-----------------------------------|-------|--------|---|----|----|----|---|



Kindled Stack - Vented Gas Log Option



Timberland Oak - Vented Gas Log Option



Woodland Birch - Vented Gas Log Option

Options & Accessories

Options & Accessories

| | | | | | | | | |
|--------|--------------------------------------|-------|--------|----|----|----|----|---|
| DV-RWA | Rock Wool, Carton of 12-4 oz. Bags.* | HTI 3 | \$ 200 | 35 | 35 | 35 | 35 | Y |
|--------|--------------------------------------|-------|--------|----|----|----|----|---|

Options & Accessories

| | | | | | | | | |
|---------|---|-------|--------|---|----|----|----|---|
| VR1000A | Volcanic Rock - Carton of 12 - 2 lb. Bags.* | HTI 3 | \$ 299 | 8 | 21 | 14 | 14 | Y |
|---------|---|-------|--------|---|----|----|----|---|

Remote Kits for SP Units

Gas Log Controls

| | | | | | | | | | |
|---------|---|-------|----|-----|----|----|----|----|---|
| LMK-SP | Left side mounting kit - safety pilot | HTI 3 | \$ | 84 | 14 | 21 | 14 | 21 | N |
| REM-KIT | On/off hi/low remote control and solenoid kit | HTI 3 | \$ | 419 | Y | Y | 14 | Y | Y |

Single Tube - Vented Burner 30"

Includes:

- Match Light or Safety Pilot Ignition
- Glowing Embers
- Vermiculite
- Sand(NG only)
- Lava Rock
- Flex Connector
- Damper Clamp



Special Considerations:

- For Timberland Oak, order VTD-OAK30 and VTD-OKEK

Required to Complete - Sold Separately: • Select burner and logs to complete set

| | | Disc. Code | MSRP USD | 004 IA | 010 PA | 014 CA | 016 NC | EXP |
|----------|---|------------|----------|--------|--------|--------|--------|-----|
| STSP30-N | Single Tube Vented Burner - 30" Safety Pilot Ignition Natural Gas | HTI 3 | \$ 549 | 21 | 14 | 14 | 14 | N |
| STSP30-P | Single Tube Vented Burner - 30" Safety Pilot Ignition Propane | HTI 3 | \$ 549 | 21 | 14 | 14 | 14 | N |

Gas Logs - Log Set Option (Required to Complete)

Kindled Stack - Vented Gas Log Option

| | | | | | | | | |
|------------|----------------------------------|-------|--------|----|----|----|----|---|
| VTD-STCK30 | 30" Kindled Stack cement log set | HTI 3 | \$ 369 | 21 | 14 | 14 | 14 | N |
|------------|----------------------------------|-------|--------|----|----|----|----|---|

Timberland Oak - Vented Gas Log Option

| | | | | | | | | |
|-----------|---|-------|--------|----|----|----|----|---|
| VTD-OKEK | Enhancement Kit for Timberland Oak set. | HTI 3 | \$ 49 | 21 | 14 | 14 | 14 | Y |
| VTD-OAK30 | 30" Timberland Oak cement log set | HTI 3 | \$ 339 | 21 | 14 | 14 | 14 | N |

Woodland Birch - Vented Gas Log Option

| | | | | | | | | |
|------------|-----------------------------------|-------|--------|----|----|----|----|---|
| VTD-BRCH30 | 30" Woodland Birch cement log set | HTI 3 | \$ 349 | 21 | 14 | 14 | 14 | N |
|------------|-----------------------------------|-------|--------|----|----|----|----|---|



Kindled Stack - Vented Gas Log Option



Timberland Oak - Vented Gas Log Option



Woodland Birch - Vented Gas Log Option

Options & Accessories

Options & Accessories

| | | | | | | | | |
|--------|--------------------------------------|-------|--------|----|----|----|----|---|
| DV-RWA | Rock Wool, Carton of 12-4 oz. Bags.* | HTI 3 | \$ 200 | 35 | 35 | 35 | 35 | Y |
|--------|--------------------------------------|-------|--------|----|----|----|----|---|

Options & Accessories

| | | | | | | | | |
|---------|---|-------|--------|---|----|----|----|---|
| VR1000A | Volcanic Rock - Carton of 12 - 2 lb. Bags.* | HTI 3 | \$ 299 | 8 | 21 | 14 | 14 | Y |
|---------|---|-------|--------|---|----|----|----|---|

Remote Kits for SP Units

Gas Log Controls

| | | | | | | | | | |
|---------|---|-------|----|-----|----|----|----|----|---|
| LMK-SP | Left side mounting kit - safety pilot | HTI 3 | \$ | 84 | 14 | 21 | 14 | 21 | N |
| REM-KIT | On/off hi/low remote control and solenoid kit | HTI 3 | \$ | 419 | Y | Y | 14 | Y | Y |

Hearth & Home Technologies

Gas Logs - Burner Option Outdoor

Stocked Item/Lead Time

004=Mt. Pleasant RDC
010=Kutztown RDC
014=Sacramento RDC
016=Charlotte RDC

EXP=Factory Expedite Program

Page printed 3/31/2025, 8:22:26 AM CDT
Current pricing updated 03/30/2025

* Please Contact Who You Purchase This Through for MSRP Pricing

Prices in USD

Non-stock and custom product cannot be cancelled.

Customer is responsible for freight for orders made outside of assigned RDC facility.

Lumonessen Outdoor

Includes:

- Up to 38,000 BTUs
- One size burner that accomodates 18" , 24" , & 30" log sizes
- 3 different log style options: Mtn. Oak, Mezmer, & Mezmer Split
- Stainless steel burner
- Piezo ignition



No additional items required to complete.

| | | Disc. Code | MSRP USD | 004 IA | 010 PA | 014 CA | 016 NC | EXP |
|-----------|--|------------|----------|--------|--------|--------|--------|-----|
| LUM-OD-NM | Lumonessen Outdoor Burner: Manual Ignition, NG: 19,000 MIN - 38,000 MAX BTUs | HTI 3 | \$ 819 | Y | Y | Y | Y | Y |
| LUM-OD-PM | Lumonessen Outdoor Burner: Manual Ignition, LP: 31,000 MIN - 38,000 MAX BTUs | HTI 3 | \$ 819 | Y | 14 | 14 | Y | Y |

Gas Logs - Log Set Option (Required to Complete)

Mezmer

| | | | | | | | | |
|---------|--------------------|-------|--------|---|---|----|---|---|
| MZMR-18 | 18" Mezmer Log Set | HTI 1 | \$ 219 | Y | Y | 14 | Y | Y |
|---------|--------------------|-------|--------|---|---|----|---|---|

Mezmer

| | | | | | | | | |
|---------|--------------------|-------|--------|---|---|---|---|---|
| MZMR-24 | 24" Mezmer Log Set | HTI 1 | \$ 229 | Y | Y | Y | Y | Y |
|---------|--------------------|-------|--------|---|---|---|---|---|

Mezmer

| | | | | | | | | |
|---------|--------------------|-------|--------|---|----|----|---|---|
| MZMR-30 | 30" Mezmer Log Set | HTI 1 | \$ 259 | Y | 14 | 14 | Y | Y |
|---------|--------------------|-------|--------|---|----|----|---|---|

Mezmer Split

| | | | | | | | | |
|-----------|--------------------------|-------|--------|---|----|----|---|---|
| MZMRSP-18 | 18" Mezmer Split Log Set | HTI 1 | \$ 219 | Y | 14 | 14 | Y | Y |
|-----------|--------------------------|-------|--------|---|----|----|---|---|

Mezmer Split

| | | | | | | | | |
|-----------|--------------------------|-------|--------|---|---|----|---|---|
| MZMRSP-24 | 24" Mezmer Split Log Set | HTI 1 | \$ 229 | Y | Y | 14 | Y | Y |
|-----------|--------------------------|-------|--------|---|---|----|---|---|

Mezmer Split

| | | | | | | | | |
|-----------|--------------------------|-------|--------|---|----|----|---|---|
| MZMRSP-30 | 30" Mezmer Split Log Set | HTI 1 | \$ 259 | Y | 14 | 14 | Y | Y |
|-----------|--------------------------|-------|--------|---|----|----|---|---|

Mountain Oak

| | | | | | | | | |
|----------|--------------------------|-------|--------|---|---|----|---|---|
| MTNOK-18 | 18" Mountain Oak Log Set | HTI 1 | \$ 219 | Y | Y | 14 | Y | Y |
|----------|--------------------------|-------|--------|---|---|----|---|---|

Mountain Oak

| | | | | | | | | | |
|----------|--------------------------|-------|----|-----|---|---|---|---|---|
| MTNOK-24 | 24" Mountain Oak Log Set | HTI 1 | \$ | 229 | Y | Y | Y | Y | Y |
|----------|--------------------------|-------|----|-----|---|---|---|---|---|

Mountain Oak

| | | | | | | | | | |
|----------|--------------------------|-------|----|-----|---|----|----|---|---|
| MTNOK-30 | 30" Mountain Oak Log Set | HTI 1 | \$ | 259 | Y | 14 | 14 | Y | Y |
|----------|--------------------------|-------|----|-----|---|----|----|---|---|



Mezmer



Mezmer Split



Mountain Oak

Outdoor 2-Tier Stadium Vented Burner 18"

Includes:

- IPI - Battery Powered Electronic Ignition
- Stainless Steel Burner and Grate
- Lava Rock
- Flex Connector
- Damper Clamp



Required to Complete - Sold Separately: • Select burner and logs to complete set

| | | Disc. Code | MSRP USD | 004 IA | 010 PA | 014 CA | 016 NC | EXP |
|--------------|---|------------|----------|--------|--------|--------|--------|-----|
| OD-2TRIP18-N | Outdoor 2-Tier Stadium Vented Burner - 18" IPI Ignition Natural Gas | HTI 3 | \$ 1,449 | 21 | 14 | 14 | 14 | N |
| OD-2TRIP18-P | Outdoor 2-Tier Stadium Vented Burner - 18" IPI Ignition Propane | HTI 3 | \$ 1,449 | 21 | 14 | 14 | 14 | N |

Gas Logs - Log Set Option (Required to Complete)

2-Tier Grand Birch - Vented Gas Log Option

| | | | | | | | | |
|------------|---------------------------------------|-------|--------|----|----|----|----|---|
| 2TR-BRCH18 | 18" 2-Tier Grand Birch cement log set | HTI 3 | \$ 369 | 21 | 14 | 14 | 14 | N |
|------------|---------------------------------------|-------|--------|----|----|----|----|---|

2-Tier Grand Oaks - Vented Gas Log Option

| | | | | | | | | |
|----------|--------------------------------------|-------|--------|---|----|----|----|---|
| 2TR-GO18 | 18" 2-Tier Grand Oaks cement log set | HTI 3 | \$ 369 | Y | 14 | 14 | 14 | N |
|----------|--------------------------------------|-------|--------|---|----|----|----|---|

2-Tier Heritage Oak - Vented Gas Log Option

| | | | | | | | | |
|-----------|--|-------|--------|----|----|----|----|---|
| 2TR-OAK18 | 18" 2-Tier Heritage Oak cement log set | HTI 3 | \$ 369 | 21 | 14 | 14 | 14 | N |
|-----------|--|-------|--------|----|----|----|----|---|



2-Tier Grand Birch - Vented Gas Log Option



2-Tier Grand Oaks - Vented Gas Log Option



2-Tier Heritage Oak - Vented Gas Log Option

Outdoor 2-Tier Stadium Vented Burner 24"

Includes:

- IPI - Battery Powered Electronic Ignition
- Stainless Steel Burner and Grate
- Lava Rock
- Flex Connector
- Damper Clamp



Required to Complete - Sold Separately: • Select burner and logs to complete set

| | | Disc. Code | MSRP USD | 004 IA | 010 PA | 014 CA | 016 NC | EXP |
|--------------|---|------------|----------|--------|--------|--------|--------|-----|
| OD-2TRIP24-N | Outdoor 2-Tier Stadium Vented Burner - 24" IPI Ignition Natural Gas | HTI 3 | \$ 1,539 | Y | 14 | | 14 | N |
| OD-2TRIP24-P | Outdoor 2-Tier Stadium Vented Burner - 24" IPI Ignition Propane | HTI 3 | \$ 1,539 | 21 | 14 | | 14 | N |

Gas Logs - Log Set Option (Required to Complete)

2-Tier Grand Birch - Vented Gas Log Option

| | | | | | | | | |
|------------|---------------------------------------|-------|--------|---|----|----|----|---|
| 2TR-BRCH24 | 24" 2-Tier Grand Birch cement log set | HTI 3 | \$ 449 | Y | 14 | 14 | 14 | N |
|------------|---------------------------------------|-------|--------|---|----|----|----|---|

2-Tier Grand Oaks - Vented Gas Log Option

| | | | | | | | | |
|----------|--------------------------------------|-------|--------|---|---|----|---|---|
| 2TR-GO24 | 24" 2-Tier Grand Oaks cement log set | HTI 3 | \$ 449 | Y | Y | 14 | Y | N |
|----------|--------------------------------------|-------|--------|---|---|----|---|---|

2-Tier Heritage Oak - Vented Gas Log Option

| | | | | | | | | |
|-----------|--|-------|--------|---|----|----|----|---|
| 2TR-OAK24 | 24" 2-Tier Heritage Oak cement log set | HTI 3 | \$ 449 | Y | 14 | 14 | 14 | N |
|-----------|--|-------|--------|---|----|----|----|---|



2-Tier Grand Birch - Vented Gas Log Option



2-Tier Grand Oaks - Vented Gas Log Option



2-Tier Heritage Oak - Vented Gas Log Option

Outdoor 2-Tier Stadium Vented Burner 30"

Includes:

- IPI - Battery Powered Electronic Ignition
- Stainless Steel Burner and Grate
- Lava Rock
- Flex Connector
- Damper Clamp



Required to Complete - Sold Separately: • Select burner and logs to complete set

| | | Disc. Code | MSRP USD | 004 IA | 010 PA | 014 CA | 016 NC | EXP |
|---------------|---|------------|----------|--------|--------|--------|--------|-----|
| OD-2TRIP130-P | Outdoor 2-Tier Stadium Vented Burner - 30" IPI Ignition Propane | HTI 3 | \$ 1,589 | Y | 14 | 14 | 14 | N |
| OD-2TRIP130-N | Outdoor 2-Tier Stadium Vented Burner - 30" IPI Ignition Natural Gas | HTI 3 | \$ 1,589 | Y | 14 | 14 | 14 | N |

Gas Logs - Log Set Option (Required to Complete)

2-Tier Grand Birch - Vented Gas Log Option

| | | | | | | | | |
|------------|---------------------------------------|-------|--------|---|----|----|----|---|
| 2TR-BRCH30 | 30" 2-Tier Grand Birch cement log set | HTI 3 | \$ 539 | Y | 14 | 14 | 14 | N |
|------------|---------------------------------------|-------|--------|---|----|----|----|---|

2-Tier Grand Oaks - Vented Gas Log Option

| | | | | | | | | |
|----------|--------------------------------------|-------|--------|---|----|----|---|---|
| 2TR-GO30 | 30" 2-Tier Grand Oaks cement log set | HTI 3 | \$ 539 | Y | 14 | 14 | Y | N |
|----------|--------------------------------------|-------|--------|---|----|----|---|---|

2-Tier Heritage Oak - Vented Gas Log Option

| | | | | | | | | |
|-----------|--|-------|--------|---|----|----|----|---|
| 2TR-OAK30 | 30" 2-Tier Heritage Oak cement log set | HTI 3 | \$ 539 | Y | 14 | 14 | 14 | N |
|-----------|--|-------|--------|---|----|----|----|---|



2-Tier Grand Birch - Vented Gas Log Option



2-Tier Grand Oaks - Vented Gas Log Option



2-Tier Heritage Oak - Vented Gas Log Option

Outdoor 3-Tier Stadium Vented Burner 18"

Includes:

- IPI - Battery Powered Electronic Ignition
- Stainless Steel Burner and Grate
- Lava Rock
- Flex Connector
- Damper Clamp



Required to Complete - Sold Separately: • Select burner and logs to complete set

| | | Disc. Code | MSRP USD | 004 IA | 010 PA | 014 CA | 016 NC | EXP |
|--------------|---|------------|----------|--------|--------|--------|--------|-----|
| OD-3TRIP18-P | Outdoor 3-Tier Stadium Vented Burner - 18" IPI Ignition Propane | HTI 3 | \$ 1,639 | 21 | 14 | 14 | 14 | N |
| OD-3TRIP18-N | Outdoor 3-Tier Stadium Vented Burner - 18" IPI Ignition Natural Gas | HTI 3 | \$ 1,639 | 21 | 14 | | 14 | N |

Gas Logs - Log Set Option (Required to Complete)

3-Tier Grand Birch - Vented Gas Log Option

| | | | | | | | | |
|------------|---------------------------------------|-------|--------|----|----|----|----|---|
| 3TR-BRCH18 | 18" 3-Tier Grand Birch cement log set | HTI 3 | \$ 609 | 21 | 14 | 14 | 14 | N |
|------------|---------------------------------------|-------|--------|----|----|----|----|---|

3-Tier Grand Oaks - Vented Gas Log Option

| | | | | | | | | |
|----------|--------------------------------------|-------|--------|---|----|----|----|---|
| 3TR-GO18 | 18" 3-Tier Grand Oaks cement log set | HTI 3 | \$ 609 | Y | 14 | 14 | 14 | N |
|----------|--------------------------------------|-------|--------|---|----|----|----|---|

3-Tier Heritage Oak - Vented Gas Log Option

| | | | | | | | | |
|-----------|--|-------|--------|----|----|----|----|---|
| 3TR-OAK18 | 18" 3-Tier Heritage Oak cement log set | HTI 3 | \$ 609 | 21 | 14 | 14 | 14 | N |
|-----------|--|-------|--------|----|----|----|----|---|



3-Tier Grand Birch - Vented Gas Log Option



3-Tier Grand Oaks - Vented Gas Log Option



3-Tier Heritage Oak - Vented Gas Log Option

Outdoor 3-Tier Stadium Vented Burner 24"

Includes:

- IPI - Battery Powered Electronic Ignition
- Stainless Steel Burner and Grate
- Lava Rock
- Flex Connector
- Damper Clamp



Required to Complete - Sold Separately: • Select burner and logs to complete set

| | | Disc. Code | MSRP USD | 004 IA | 010 PA | 014 CA | 016 NC | EXP |
|--------------|---|------------|----------|--------|--------|--------|--------|-----|
| OD-3TRIP24-N | Outdoor 3-Tier Stadium Vented Burner - 24" IPI Ignition Natural Gas | HTI 3 | \$ 1,719 | 21 | 14 | | 14 | N |
| OD-3TRIP24-P | Outdoor 3-Tier Stadium Vented Burner - 24" IPI Ignition Propane | HTI 3 | \$ 1,719 | 21 | 14 | 14 | 14 | N |

Gas Logs - Log Set Option (Required to Complete)

3-Tier Grand Birch - Vented Gas Log Option

| | | | | | | | | |
|------------|---------------------------------------|-------|--------|---|----|----|----|---|
| 3TR-BRCH24 | 24" 3-Tier Grand Birch cement log set | HTI 3 | \$ 619 | Y | 14 | 14 | 14 | N |
|------------|---------------------------------------|-------|--------|---|----|----|----|---|

3-Tier Grand Oaks - Vented Gas Log Option

| | | | | | | | | |
|----------|--------------------------------------|-------|--------|---|----|----|---|---|
| 3TR-GO24 | 24" 3-Tier Grand Oaks cement log set | HTI 3 | \$ 619 | Y | 14 | 14 | Y | N |
|----------|--------------------------------------|-------|--------|---|----|----|---|---|

3-Tier Heritage Oak - Vented Gas Log Option

| | | | | | | | | |
|-----------|--|-------|--------|---|----|----|----|---|
| 3TR-OAK24 | 24" 3-Tier Heritage Oak cement log set | HTI 3 | \$ 619 | Y | 14 | 14 | 14 | N |
|-----------|--|-------|--------|---|----|----|----|---|



3-Tier Grand Birch - Vented Gas Log Option

3-Tier Grand Oaks - Vented Gas Log Option

3-Tier Heritage Oak - Vented Gas Log Option

Outdoor 3-Tier Stadium Vented Burner 30"

Includes:

- IPI - Battery Powered Electronic Ignition
- Stainless Steel Burner and Grate
- Lava Rock
- Flex Connector
- Damper Clamp



Required to Complete - Sold Separately: • Select burner and logs to complete set

| | | Disc. Code | MSRP USD | 004 IA | 010 PA | 014 CA | 016 NC | EXP |
|---------------|---|------------|----------|--------|--------|--------|--------|-----|
| OD-3TRIP130-N | Outdoor 3-Tier Stadium Vented Burner - 30" IPI Ignition Natural Gas | HTI 3 | \$ 1,789 | Y | 14 | 14 | 14 | N |
| OD-3TRIP130-P | Outdoor 3-Tier Stadium Vented Burner - 30" IPI Ignition Propane | HTI 3 | \$ 1,789 | 21 | 14 | 14 | 14 | N |

Gas Logs - Log Set Option (Required to Complete)

3-Tier Grand Birch - Vented Gas Log Option

| | | | | | | | | |
|------------|---------------------------------------|-------|--------|---|----|----|----|---|
| 3TR-BRCH30 | 30" 3-Tier Grand Birch cement log set | HTI 3 | \$ 689 | Y | 14 | 14 | 14 | N |
|------------|---------------------------------------|-------|--------|---|----|----|----|---|

3-Tier Grand Oaks - Vented Gas Log Option

| | | | | | | | | |
|----------|--------------------------------------|-------|--------|---|----|--|---|---|
| 3TR-GO30 | 30" 3-Tier Grand Oaks cement log set | HTI 3 | \$ 689 | Y | 14 | | Y | N |
|----------|--------------------------------------|-------|--------|---|----|--|---|---|

3-Tier Heritage Oak - Vented Gas Log Option

| | | | | | | | | |
|-----------|--|-------|--------|---|----|----|----|---|
| 3TR-OAK30 | 30" 3-Tier Heritage Oak cement log set | HTI 3 | \$ 689 | Y | 14 | 14 | 14 | N |
|-----------|--|-------|--------|---|----|----|----|---|



3-Tier Grand Birch - Vented Gas Log Option



3-Tier Grand Oaks - Vented Gas Log Option



3-Tier Heritage Oak - Vented Gas Log Option

Outdoor Single Tube - Vented Burner 18"

Includes:

- Match Light or Safety Pilot Ignition
- Stainless Steel Burner and Grate
- Lava Rock
- Flex Connector
- Damper Clamp



Special Considerations:

- VTD-OAK18 includes both Timberland Oak and Smoldering Timberland Oak Logs

Required to Complete - Sold Separately: • Select burner and logs to complete set

| | | Disc. Code | MSRP USD | 004 IA | 010 PA | 014 CA | 016 NC | EXP |
|-------------|---|------------|----------|--------|--------|--------|--------|-----|
| OD-STM18-N | Outdoor Single Tube Vented Burner - 18" Manual Ignition Natural Gas | HTI 3 | \$ 859 | 21 | 14 | 14 | 14 | N |
| OD-STSP18-P | Outdoor Single Tube Vented Burner - 18" Safety Pilot Ignition Propane | HTI 3 | \$ 989 | 21 | 14 | 14 | 14 | N |
| OD-STSP18-N | | HTI 3 | \$ 989 | | | | 14 | N |

Gas Logs - Log Set Option (Required to Complete)

Kindled Stack - Vented Gas Log Option

| | | | | | | | | |
|------------|----------------------------------|-------|--------|---|----|----|----|---|
| VTD-STCK18 | 18" Kindled Stack cement log set | HTI 3 | \$ 259 | Y | 14 | 14 | 14 | N |
|------------|----------------------------------|-------|--------|---|----|----|----|---|

Timberland Oak - Vented Gas Log Option

| | | | | | | | | |
|-----------|-----------------------------------|-------|--------|---|----|----|----|---|
| VTD-OAK18 | 18" Timberland Oak cement log set | HTI 3 | \$ 229 | Y | 14 | 14 | 14 | N |
|-----------|-----------------------------------|-------|--------|---|----|----|----|---|

Woodland Birch - Vented Gas Log Option

| | | | | | | | | |
|------------|-----------------------------------|-------|--------|---|----|----|----|---|
| VTD-BRCH18 | 18" Woodland Birch cement log set | HTI 3 | \$ 239 | Y | 14 | 14 | 14 | N |
|------------|-----------------------------------|-------|--------|---|----|----|----|---|



Kindled Stack - Vented Gas Log Option



Timberland Oak - Vented Gas Log Option



Woodland Birch - Vented Gas Log Option

Outdoor Single Tube - Vented Burner 24"

Includes:

- Match Light or Safety Pilot Ignition
- Stainless Steel Burner and Grate
- Lava Rock
- Flex Connector
- Damper Clamp



Special Considerations:

- VTD-OAK24 includes both Timberland Oak and Smoldering Timberland Oak Logs

Required to Complete - Sold Separately: • Select burner and logs to complete set

| | | Disc. Code | MSRP USD | 004 IA | 010 PA | 014 CA | 016 NC | EXP |
|-------------|---|------------|----------|--------|--------|--------|--------|-----|
| OD-STSP24-N | Outdoor Single Tube Vented Burner - 24" Safety Pilot Ignition Natural Gas | HTI 3 | \$ 1,099 | | | | 14 | N |
| OD-STSP24-P | Outdoor Single Tube Vented Burner - 24" Safety Pilot Ignition Propane | HTI 3 | \$ 1,099 | 21 | 14 | 14 | 14 | N |

Gas Logs - Log Set Option (Required to Complete)

Kindled Stack - Vented Gas Log Option

| | | | | | | | | |
|------------|----------------------------------|-------|--------|---|----|----|----|---|
| VTD-STCK24 | 24" Kindled Stack cement log set | HTI 3 | \$ 319 | Y | 14 | 14 | 14 | N |
|------------|----------------------------------|-------|--------|---|----|----|----|---|

Timberland Oak - Vented Gas Log Option

| | | | | | | | | |
|-----------|-----------------------------------|-------|--------|---|----|----|----|---|
| VTD-OAK24 | 24" Timberland Oak cement log set | HTI 3 | \$ 289 | Y | 14 | 14 | 14 | N |
|-----------|-----------------------------------|-------|--------|---|----|----|----|---|

Woodland Birch - Vented Gas Log Option

| | | | | | | | | |
|------------|-----------------------------------|-------|--------|---|----|----|----|---|
| VTD-BRCH24 | 24" Woodland Birch cement log set | HTI 3 | \$ 299 | Y | 14 | 14 | 14 | N |
|------------|-----------------------------------|-------|--------|---|----|----|----|---|



Kindled Stack - Vented Gas Log Option



Timberland Oak - Vented Gas Log Option



Woodland Birch - Vented Gas Log Option

Hearth & Home Technologies

Power Vent

Stocked Item/Lead Time

004=Mt. Pleasant RDC
 010=Kutztown RDC
 014=Sacramento RDC
 016=Charlotte RDC

EXP=Factory Expedite Program

Prices in USD

Page printed 3/31/2025, 8:22:26 AM CDT

* Please Contact Who You Purchase This Through for MSRP Pricing

Non-stock and custom product cannot be cancelled.

Customer is responsible for freight for orders made outside of assigned RDC facility.

PVV-SLEEVE

| | | Disc. Code | MSRP USD | 004 IA | 010 PA | 014 CA | 016 NC | EXP |
|---------------|--|------------|----------|--------|--------|--------|--------|-----|
| PVV-SLEEVE-12 | 12" long sleeve for use with PVV-SLP to protect the wire harness; 8" diameter, uses DVP flashing for roof terminations | HTI 1 | \$ 79 | Y | Y | Y | Y | Y |
| PVV-SLEEVE-48 | 48" long sleeve for use with PVV-SLP to protect the wire harness; 8" diameter, uses DVP flashing for roof terminations | HTI 1 | \$ 134 | Y | Y | Y | Y | Y |

PVV-SLP

| | | Disc. Code | MSRP USD | 004 IA | 010 PA | 014 CA | 016 NC | EXP |
|---------|--|------------|----------|--------|--------|--------|--------|-----|
| PVV-SLP | Vertical Power Vent, includes a DVP storm collar. May require PV-IPI-CK, refer to venting notes on the fireplace price page. PVV-SLEEVE-12 or PVV-SLEEVE-48 required to complete, wire harness required to complete. | HTI 1 | \$ 1,850 | Y | Y | Y | Y | Y |

PVLP-SLP - Low Profile Power Vent

| | | Disc. Code | MSRP USD | 004 IA | 010 PA | 014 CA | 016 NC | EXP |
|----------|---|------------|----------|--------|--------|--------|--------|-----|
| PVLP-SLP | Low Profile Power Vent, may require PV-IPI-CK kit. Refer to Venting Notes on the fireplace price page. Wire harness required to complete. | HTI 1 | \$ 1,850 | Y | Y | Y | Y | Y |

Power Vent

| | | Disc. Code | MSRP USD | 004 IA | 010 PA | 014 CA | 016 NC | EXP |
|-----------|--|------------|----------|--------|--------|--------|--------|-----|
| PVI-SLP-B | Inline Power Vent, may require PV-IPI-CK kit. Refer to Venting Notes on the fireplace price page. Wire harness required to complete. | HTI 1 | \$ 1,850 | Y | Y | 14 | 14 | N |

Powervent

| | | Disc. Code | MSRP USD | 004 IA | 010 PA | 014 CA | 016 NC | EXP |
|---------|--------------------------|---------------|-------------|-----------|-----------|-----------|-----------|-----|
| RS12 | External Mount Powervent | STL null | * | | | | | N |
| RSIF160 | Inline Powervent | STL null | * | | | | | N |
| RSIF180 | Inline Powervent | STL null | * | | | | | N |
| RS14 | External Mount Powervent | STL null | * | | | | | N |
| RS16 | External Mount Powervent | STL null | * | | | | | N |

PVI-SLP - Term Kits and Acc

| | | Disc. Code | MSRP USD | 004 IA | 010 PA | 014 CA | 016 NC | EXP |
|---------|-----------------|---------------|-------------|-----------|-----------|-----------|-----------|-----|
| LPC-BEK | Brick kit | HTI 1 | \$ 98 | 8 | 21 | 14 | 14 | Y |
| SLP-LPC | Low profile cap | HTI 1 | \$ 681 | 8 | 21 | 14 | 14 | Y |

PVLP-SLP - Accessories

| | | Disc. Code | MSRP USD | 004 IA | 010 PA | 014 CA | 016 NC | EXP |
|-----------|--|---------------|-------------|-----------|-----------|-----------|-----------|-----|
| PVLP-HS | Low Profile Power Vent Heat Shield (optional) | HTI 1 | \$ 78 | 8 | 21 | 14 | 14 | Y |
| PVLP-BEK | Brick extension kit for Low Profile Power Vent | HTI 1 | \$ 90 | Y | Y | Y | 14 | Y |
| PV-IPI-CK | Power Vent conversion kit required for IntelliFire and IntelliFire Plus Gas Fireplaces | HTI 1 | \$ 391 | Y | Y | Y | 14 | Y |

Hearth & Home Technologies

Wire Harness

Stocked Item/Lead Time

004=Mt. Pleasant RDC
 010=Kutztown RDC
 014=Sacramento RDC
 016=Charlotte RDC

EXP=Factory Expedite Program

Prices in USD

Page printed 3/31/2025, 8:22:26 AM CDT

* Please Contact Who You Purchase This Through for MSRP Pricing

Non-stock and custom product cannot be cancelled.

Customer is responsible for freight for orders made outside of assigned RDC facility.

Power Vent - Wire Harness

| | | Disc. Code | MSRP USD | 004 IA | 010 PA | 014 CA | 016 NC | EXP |
|-----------|---|------------|----------|--------|--------|--------|--------|-----|
| PVI-WH10 | 10 foot Power Vent Wire Harness for use with PVLP-SLP, PVV-SLP and PVI-SLP-B | HTI 1 | \$ 137 | Y | 21 | Y | 14 | Y |
| PVI-WH20 | 20 foot Power Vent Wire Harness for use with PVLP-SLP, PVV-SLP and PVI-SLP-B | HTI 1 | \$ 191 | Y | Y | Y | 14 | Y |
| PVI-WH40 | 40 foot Power Vent Wire Harness for use with PVLP-SLP, PVV-SLP and PVI-SLP-B | HTI 1 | \$ 243 | Y | Y | Y | Y | Y |
| PVI-WH60 | 60 foot Power Vent Wire Harness for use with PVLP-SLP, PVV-SLP and PVI-SLP-B | HTI 1 | \$ 298 | Y | Y | 14 | 14 | Y |
| PVI-WH80 | 80 foot Power Vent Wire Harness for use with PVLP-SLP, PVV-SLP and PVI-SLP-B | HTI 1 | \$ 338 | 21 | 21 | 21 | 14 | Y |
| PVI-WH100 | 100 foot Power Vent Wire Harness for use with PVLP-SLP, PVV-SLP and PVI-SLP-B | HTI 1 | \$ 391 | 14 | 28 | 14 | 14 | Y |
| PVMW100 | Wire harness for PVLP-SLP Power Vent installed on Signature Command fireplace, 100 ft | VCG 1 | \$ 746 | 8 | 21 | 14 | 14 | Y |

Hearth & Home Technologies

Venting

Stocked Item/Lead Time

004=Mt. Pleasant RDC
010=Kutztown RDC
014=Sacramento RDC
016=Charlotte RDC

EXP=Factory Expedite Program

Prices in USD

Page printed 3/31/2025, 8:22:26 AM CDT

* Please Contact Who You Purchase This Through for MSRP Pricing

Non-stock and custom product cannot be cancelled.

Customer is responsible for freight for orders made outside of assigned RDC facility.

Brick Extension Kit

| | | Disc. Code | MSRP USD | 004 IA | 010 PA | 014 CA | 016 NC | EXP |
|--------------|--|------------|----------|--------|--------|--------|--------|-----|
| HEAT-OUT-BEK | Exterior Heat-Zone brick extension kit | HTI 1 | \$ 73 | 8 | 21 | 21 | 14 | Y |

Decorative Termination Caps/Shrouds for Wood and Gas Units - Termination

| | | Disc. Code | MSRP USD | 004 IA | 010 PA | 014 CA | 016 NC | EXP |
|-----------|--|------------|----------|--------|--------|--------|--------|-----|
| CT-3A-B | Chimney adapter for use with DTS & DTO caps on SL300 pipe | HTI 1 | \$ 199 | 8 | 21 | 14 | 14 | Y |
| CT-11A-B | Chimney adapter for use with DTS & DTO caps on SL1100 pipe | HTI 1 | \$ 226 | Y | 14 | 14 | 14 | Y |
| CT-14A | Chimney adapter for use with DTS & DTO caps on 14" DuraChimney | HTI 1 | \$ 267 | 8 | 21 | 14 | 14 | Y |
| LDS33 | Vertical 3' x 3' (915mm x 915mm) field adjustable, UL listed decorative shroud for use with TS and TR termination caps | HTI 1 | \$ 401 | 8 | 21 | 14 | 14 | Y |
| LDS46 | Vertical 4' x 6' (1220mm x 1830mm) field adjustable, UL listed decorative shroud for use with TS and TR termination caps | HTI 1 | \$ 756 | 8 | Y | 14 | 14 | Y |
| LDS46-M | 40 piece multi-pack of UL listed vertical shroud "corner posts" for field fabrication of shroud | HTI 1 | \$ 909 | Y | 21 | 14 | 14 | Y |
| DTO134-BK | Decorative Termination Octagon 34" - black (adapter required for wood pipe) | HTI 1 | \$ 1,709 | 8 | 21 | 14 | 14 | Y |
| DTS134-CP | Decorative Termination Square 34" - faux copper (Adapter required for wood) | HTI 1 | \$ 1,709 | Y | 21 | 14 | Y | N |
| DTO134-CP | Decorative Termination Octagon 34" - faux copper (Adapter required for wood) | HTI 1 | \$ 1,709 | Y | 14 | 14 | 14 | N |
| DTS134-BK | Decorative Termination Square 34" - Black (Adapter required for wood) | HTI 1 | \$ 1,709 | Y | 14 | 14 | Y | N |
| DTS146-BK | Decorative Termination Square 46" - Black (Adapter required for wood) | HTI 1 | \$ 1,882 | 8 | 21 | 14 | 14 | N |
| DTS146-CP | Decorative Termination Square 46" - faux copper (Adapter required for wood) | HTI 1 | \$ 1,882 | Y | 21 | 14 | 14 | N |
| DTO146-CP | Decorative Termination Octagon 46" - faux copper (Adapter required for wood) | HTI 1 | \$ 1,882 | Y | 21 | 14 | Y | N |
| DTO146-BK | Decorative Termination Octagon 46" - Black (Adapter required for wood) | HTI 1 | \$ 1,882 | Y | 14 | 14 | 14 | N |

Decorative Termination for Wood Units - Termination

| | | Disc. Code | MSRP USD | 004 IA | 010 PA | 014 CA | 016 NC | EXP |
|--------|---|------------|----------|--------|--------|--------|--------|-----|
| TR-TVK | Round termination top adaptor kit for shrouds | HTI 1 | \$ 124 | Y | Y | Y | Y | Y |

8" DuraPlus - Adapter/Increaser/Tee

| | | Disc. Code | MSRP USD | 004 IA | 010 PA | 014 CA | 016 NC | EXP |
|------------|----------------------------|------------|----------|--------|--------|--------|--------|-----|
| DV-8DP-TSS | 8" DuraPlus tee w/cap (SS) | HTI 5 | \$ 857 | 35 | 35 | 28 | 35 | N |

8" DuraPlus - Anchor

| | | Disc. Code | MSRP USD | 004 IA | 010 PA | 014 CA | 016 NC | EXP |
|-----------|------------------------|---------------|-------------|-----------|-----------|-----------|-----------|-----|
| DV-8DP-BP | 8" DuraPlus base plate | HTI 5 | \$ 169 | 35 | 14 | 28 | 14 | N |

8" DuraPlus - Firestop/Straps/Support

| | | Disc. Code | MSRP USD | 004 IA | 010 PA | 014 CA | 016 NC | EXP |
|--------------|--------------------------------------|---------------|-------------|-----------|-----------|-----------|-----------|-----|
| DV-8DP-WT | 8" DuraPlus wall thimble | HTI 5 | \$ 224 | 35 | 35 | 28 | 35 | N |
| DV-8DP-WTSS | 8" DuraPlus wall thimble (SS) | HTI 5 | \$ 260 | 35 | 35 | 28 | 35 | N |
| DV-8DP-TSB | 8" DuraPlus tee support bracket (GA) | HTI 5 | \$ 282 | 35 | 35 | 28 | 35 | N |
| DV-8DP-CS11 | 8X11 DuraPlus square ceiling support | HTI 5 | \$ 291 | 35 | 35 | 28 | 35 | N |
| DV-8DP-TSBSS | 8" DuraPlus tee support bracket (SS) | HTI 5 | \$ 445 | 35 | 35 | 28 | 35 | N |
| DV-8DP-CS36 | 8X36 DuraPlus square ceiling support | HTI 5 | \$ 493 | 35 | 35 | 28 | 35 | N |

6" DuraPlus

| | | Disc. Code | MSRP USD | 004 IA | 010 PA | 014 CA | 016 NC | EXP |
|---------------|---|---------------|-------------|-----------|-----------|-----------|-----------|-----|
| DV-6DP-WS | 6" DuraPlus wall strap | HTI 5 | \$ 70 | 35 | 35 | 28 | 35 | N |
| DV-6DP-ES | 6" DuraPlus elbow strap | HTI 5 | \$ 84 | 35 | 35 | 28 | 35 | N |
| DV-6DP-WSSS | 6" DuraPlus wall strap - stainless steel | HTI 5 | \$ 88 | 35 | 35 | 28 | 35 | N |
| DV-6DP-09 | 6x9 DuraPlus pipe | HTI 5 | \$ 168 | 35 | 35 | 28 | 35 | N |
| DV-6DP-FRS | 6" DuraPlus firestop radiation shield | HTI 5 | \$ 169 | 35 | 35 | 28 | 35 | N |
| DV-6DP-WT | 6" DuraPlus wall thimble | HTI 5 | \$ 174 | 35 | 35 | 28 | 35 | N |
| DV-6DP-IS | 6" DuraPlus attic insulation shield | HTI 5 | \$ 188 | 35 | 35 | 28 | 35 | N |
| DV-6DP-CCS48 | 6x48 DuraPlus close clearance shield | HTI 5 | \$ 206 | 35 | 35 | 28 | 35 | N |
| DV-6DP-TSB | 6" DuraPlus tee support bracket | HTI 5 | \$ 227 | 35 | 35 | 28 | 35 | N |
| DV-6DP-RCS | 6" DuraPlus RD ceiling support box | HTI 5 | \$ 277 | 35 | 35 | 28 | 35 | N |
| DV-6DP-CCS36 | 6x36 DuraPlus close clearance shield | HTI 5 | \$ 315 | 35 | 35 | 28 | 35 | N |
| DV-6DP-F12DSA | 6" DuraPlus DSA flashing 7/12-12/12 | HTI 5 | \$ 375 | 35 | 35 | 28 | 35 | N |
| DV-6DP-TSBSS | 6" DuraPlus tee support bracket - stainless steel | HTI 5 | \$ 445 | 35 | 35 | 28 | 35 | N |
| DV-6DP-CS36 | 6x36 DuraPlus square ceiling support box | HTI 5 | \$ 504 | 35 | 35 | 28 | 35 | N |
| DV-6DP-T | 6" DuraPlus tee with cap | HTI 5 | \$ 541 | 35 | 35 | 28 | 35 | N |
| DV-6DP-F24 | 6" DuraPlus flashing 19/12-24/12 | HTI 5 | \$ 572 | 35 | 35 | 28 | 35 | N |
| DV-6DP-TSS | 6" DuraPlus tee with cap - stainless steel | HTI 5 | \$ 604 | 35 | 35 | 28 | 35 | N |
| DV-6DP-E15 | 6" DuraPlus 15 Degree elbow kit | HTI 5 | \$ 669 | 35 | 35 | 28 | 35 | N |
| DV-6DP-F18 | 6" DuraPlus 13/12-18/12 | HTI 5 | \$ 945 | 35 | 35 | 28 | 35 | N |
| DV-6DP-KMFG | 6" DuraPlus multi-fuel home kit | HTI 5 | \$ 1,360 | 35 | 35 | 28 | 35 | N |
| DV-6DP-CCS60 | 6x60 DuraPlus close clearance shield | HTI 5 | \$ 1,663 | 35 | 35 | 28 | 35 | N |

6" B-Vent Components - Adapter/Incraser/Tee

| | | Disc. Code | MSRP USD | 004 IA | 010 PA | 014 CA | 016 NC | EXP |
|----------|-----------------------------|---------------|-------------|-----------|-----------|-----------|-----------|-----|
| DV-6BVC | 6BVC - Draft Hood Connector | HTI 5 | \$ 39 | 35 | 35 | 28 | 35 | Y |
| DV-6BV36 | 6X36 LENGTH B-VENT | HTI 5 | \$ 94 | Y | 14 | 14 | Y | Y |

6" B-Vent Components - Elbow

| | | Disc. Code | MSRP USD | 004 IA | 010 PA | 014 CA | 016 NC | EXP |
|-----------|--|---------------|-------------|-----------|-----------|-----------|-----------|-----|
| DV-6BVL45 | 6BVL45 - 45/60 Degree Adjustable Elbow | HTI 5 | \$ 73 | Y | 14 | 14 | Y | Y |
| DV-6BVL90 | 6BVL90 - 90 Degree Adjustable Elbow | HTI 5 | \$ 126 | Y | 14 | 28 | Y | Y |

6" B-Vent Components - Firestop/Straps/Support

| | | Disc. Code | MSRP USD | 004 IA | 010 PA | 014 CA | 016 NC | EXP |
|----------|------------------------------|---------------|-------------|-----------|-----------|-----------|-----------|-----|
| DV-6BVFS | 6BVFS - Firestop Spacer | HTI 5 | \$ 20 | Y | 14 | 28 | Y | Y |
| DV-6BVS | 6BVS - Gas Vent Roof Support | HTI 5 | \$ 37 | 35 | 35 | 28 | 35 | Y |

6" B-Vent Components - Shield/Flashing/Collars

| | | Disc. Code | MSRP USD | 004 IA | 010 PA | 014 CA | 016 NC | EXP |
|------------|---------------------------------|---------------|-------------|-----------|-----------|-----------|-----------|-----|
| DV-6BVF | 6BVF - Adjustable Roof Flashing | HTI 5 | \$ 71 | 35 | 14 | Y | 14 | N |
| DV-6BVFSR | 6BVFSR - Steep Roof Flashing | HTI 5 | \$ 121 | Y | Y | 28 | 14 | Y |
| DV-6BVFDSA | 6BVFDSA - 6" DSA Roof Flashing | HTI 5 | \$ 139 | 35 | 14 | Y | 14 | Y |

6" B-Vent Components - Straight Section

| | | Disc. Code | MSRP USD | 004 IA | 010 PA | 014 CA | 016 NC | EXP |
|-----------|---|---------------|-------------|-----------|-----------|-----------|-----------|-----|
| DV-6BV06 | 6BVDV-6 - 6" Length Round Rigid Pipe | HTI 5 | \$ 44 | Y | 14 | 28 | Y | Y |
| DV-6BV12 | 6BV12 - 12" Length Round Rigid Pipe | HTI 5 | \$ 45 | Y | 14 | 28 | Y | Y |
| DV-6BV18 | 6BV18 - 18" Length Round Rigid Pipe | HTI 5 | \$ 52 | Y | 14 | 28 | Y | Y |
| DV-6BV12A | 6BV12A - 12" Length Round Adjustable Pipe | HTI 5 | \$ 56 | 35 | 14 | 28 | Y | Y |
| DV-6BV24 | 6BV24 - 24" Length Round Rigid Pipe | HTI 5 | \$ 73 | Y | 14 | 28 | Y | Y |
| DV-6BV48 | 6BV48 - 48" Length Round Rigid Pipe | HTI 5 | \$ 121 | Y | 14 | 28 | Y | Y |
| DV-6BV60 | 6BV60 - 60" Length Round Rigid Pipe | HTI 5 | \$ 142 | Y | 14 | 14 | Y | Y |

6" B-Vent Terminations - Termination

| | | Disc. Code | MSRP USD | 004 IA | 010 PA | 014 CA | 016 NC | EXP |
|-----------|------------------------|---------------|-------------|-----------|-----------|-----------|-----------|-----|
| DV-6BVDC | 6BVDC - DuraCap | HTI 5 | \$ 74 | Y | 14 | 28 | 14 | Y |
| DV-6BVTTH | 6BVTTH - High-Wind Cap | HTI 5 | \$ 87 | Y | 21 | 21 | Y | Y |

6" B-vent Quick Grip Firestop/Support

| | | Disc. Code | MSRP USD | 004 IA | 010 PA | 014 CA | 016 NC | EXP |
|------------|---------------------------------------|---------------|-------------|-----------|-----------|-----------|-----------|-----|
| DV-6BVFSPU | 6" B-vent Quick Grip Firestop/Support | HTI 5 | \$ 83 | 35 | 35 | 28 | 35 | Y |

6" B-Vent Terminations - Shield/Flashing/Coll

| | | Disc. | MSRP | 004 | 010 | 014 | 016 | EXP |
|----------|----------------------|-------|-------|-----|-----|-----|-----|-----|
| | | Code | USD | IA | PA | CA | NC | |
| DV-6BVSC | 6BVSC - Storm Collar | HTI 5 | \$ 19 | Y | 14 | 28 | Y | Y |

6" B-vent Wall Support/Band Assembly

| | | Disc. | MSRP | 004 | 010 | 014 | 016 | EXP |
|-----------|--------------------------------------|-------|--------|-----|-----|-----|-----|-----|
| | | Code | USD | IA | PA | CA | NC | |
| DV-6BVWSB | 6" B-vent Wall Support/Band Assembly | HTI 5 | \$ 108 | 35 | 35 | 28 | 35 | Y |

8" B-Vent Components - Elbow

| | | Disc. | MSRP | 004 | 010 | 014 | 016 | EXP |
|----------|-------------------------|-------|-------|-----|-----|-----|-----|-----|
| | | Code | USD | IA | PA | CA | NC | |
| DV-8BVVS | SQUARE FIRESTOP SUPPORT | HTI 5 | \$ 90 | 35 | 35 | 28 | 35 | Y |

8" B-Vent Components - Elbow

| | | Disc. | MSRP | 004 | 010 | 014 | 016 | EXP |
|-----------|----------------------------|-------|--------|-----|-----|-----|-----|-----|
| | | Code | USD | IA | PA | CA | NC | |
| DV-8BVL45 | 45 Degree Adjustable Elbow | HTI 5 | \$ 123 | Y | 14 | 28 | 14 | Y |
| DV-8BVL90 | 90 Degree Adjustable Elbow | HTI 5 | \$ 194 | Y | 14 | 28 | 14 | Y |

8" B-vent Wall Support/Band Assembly

| | | Disc. | MSRP | 004 | 010 | 014 | 016 | EXP |
|-----------|--------------------------------------|-------|--------|-----|-----|-----|-----|-----|
| | | Code | USD | IA | PA | CA | NC | |
| DV-8BVWSB | 8" B-vent Wall Support/Band Assembly | HTI 0 | \$ 126 | 35 | 35 | 28 | 35 | Y |

8" B-Vent Components - Termination

| | | Disc. | MSRP | 004 | 010 | 014 | 016 | EXP |
|-----------|---------------|-------|--------|-----|-----|-----|-----|-----|
| | | Code | USD | IA | PA | CA | NC | |
| DV-8BVVTH | High-Wind Cap | HTI 5 | \$ 132 | 35 | 35 | 28 | 35 | Y |

8" B-Vent Components - Firestop/Straps/Support

| | | Disc. | MSRP | 004 | 010 | 014 | 016 | EXP |
|----------|--------------|-------|-------|-----|-----|-----|-----|-----|
| | | Code | USD | IA | PA | CA | NC | |
| DV-8BVWT | Wall Thimble | HTI 5 | \$ 87 | Y | 14 | 28 | 14 | Y |

8" B-Vent Components - Shield/Flashing/Collars

| | | Disc. Code | MSRP USD | 004 IA | 010 PA | 014 CA | 016 NC | EXP |
|-----------|---------------------------------|---------------|-------------|-----------|-----------|-----------|-----------|-----|
| DV-8BVSC | Storm Collar | HTI 5 | \$ 23 | 35 | 14 | 28 | 14 | Y |
| DV-8BVFS | Firestop Spacer | HTI 5 | \$ 37 | Y | 14 | 28 | 14 | Y |
| DV-8BVF | Adjustable Roof Flashing | HTI 5 | \$ 94 | 35 | 35 | 28 | 35 | Y |
| DV-8BVFF | Tall Cone Flat Flashing | HTI 5 | \$ 129 | 35 | 35 | 28 | 35 | Y |
| DV-8BVFSR | Steep Roof Flashing | HTI 5 | \$ 188 | 35 | 14 | 14 | 14 | Y |
| DV-7BVIS | Attic Insulation Shield 7" - 8" | HTI 5 | \$ 255 | 35 | 14 | 28 | 14 | Y |

8" B-Vent Components - Elbow

| | | Disc. Code | MSRP USD | 004 IA | 010 PA | 014 CA | 016 NC | EXP |
|-----------|----------------------------------|---------------|-------------|-----------|-----------|-----------|-----------|-----|
| DV-8BV12 | 12" Length Round Rigid Pipe | HTI 5 | \$ 74 | Y | 14 | 28 | 14 | Y |
| DV-8BV12A | 12" Length Round Adjustable Pipe | HTI 5 | \$ 84 | Y | 14 | 28 | 14 | Y |
| DV-8BV18 | 18" Length Round Rigid Pipe | HTI 5 | \$ 84 | Y | 14 | 28 | 14 | Y |
| DV-8BV24 | 24" Length Round Rigid Pipe | HTI 5 | \$ 120 | Y | 14 | 28 | 14 | Y |
| DV-8BV36 | 36" Length Round Rigid Pipe | HTI 5 | \$ 153 | Y | 14 | 28 | 14 | Y |
| DV-8BV48 | 48" Length Round Rigid Pipe | HTI 5 | \$ 209 | Y | 14 | 28 | 14 | Y |
| DV-8BV60 | 60" Length Round Rigid Pipe | HTI 5 | \$ 242 | Y | 14 | 28 | 14 | Y |

10" B-Vent Components - Elbow

| | | Disc. Code | MSRP USD | 004 IA | 010 PA | 014 CA | 016 NC | EXP |
|------------|----------------------------|---------------|-------------|-----------|-----------|-----------|-----------|-----|
| DV-10BVL45 | 45 Degree Adjustable Elbow | HTI 5 | \$ 304 | Y | Y | 28 | 14 | Y |

10" B-vent Draft Hood Connector

| | | Disc. Code | MSRP USD | 004 IA | 010 PA | 014 CA | 016 NC | EXP |
|----------|---------------------------------|---------------|-------------|-----------|-----------|-----------|-----------|-----|
| DV-10BVC | 10" B-vent Draft Hood Connector | HTI 5 | \$ 138 | 35 | 35 | 28 | 35 | Y |

10" B-vent High Wind Cap

| | | Disc. Code | MSRP USD | 004 IA | 010 PA | 014 CA | 016 NC | EXP |
|-----------|--------------------------|---------------|-------------|-----------|-----------|-----------|-----------|-----|
| DV-10BVVT | 10" B-vent High Wind Cap | HTI 5 | \$ 356 | 35 | 14 | 28 | 14 | Y |

10" B-Vent Components - Firestop/Straps/Support

| | | Disc. Code | MSRP USD | 004 IA | 010 PA | 014 CA | 016 NC | EXP |
|-----------|------------------------------------|---------------|-------------|-----------|-----------|-----------|-----------|-----|
| DV-7DP-WS | Wall Strap (DuraPlus Mult applies) | HTI 5 | \$ 96 | Y | 14 | 28 | 14 | Y |
| DV-10GVFS | Firestop Spacer | HTI 5 | \$ 113 | Y | 14 | 28 | 14 | Y |

10" B-Vent Components - Shield/Flashing/Collars

| | | Disc. Code | MSRP USD | 004 IA | 010 PA | 014 CA | 016 NC | EXP |
|-----------|--------------------------|---------------|-------------|-----------|-----------|-----------|-----------|-----|
| DV-10BVSC | Storm Collar | HTI 5 | \$ 34 | 35 | 42 | 28 | 42 | Y |
| DV-10BVF | Adjustable Roof Flashing | HTI 5 | \$ 127 | 35 | 14 | 28 | 14 | Y |
| DV-10BVFF | Tall Cone Flat Flashing | HTI 5 | \$ 178 | Y | 14 | 28 | 14 | Y |

10" B-Vent Components - Straight Section

| | | Disc. Code | MSRP USD | 004 IA | 010 PA | 014 CA | 016 NC | EXP |
|------------|--------------------------|---------------|-------------|-----------|-----------|-----------|-----------|-----|
| DV-10BV18 | 18* LENGTH OF 10* B-VENT | HTI 5 | \$ 221 | Y | 14 | 28 | 14 | Y |
| DV-10BV36 | 36* LENGTH OF 10* B-VENT | HTI 5 | \$ 313 | Y | Y | 28 | 14 | Y |
| DV-10BV18A | 18* ADJ LENTH OF 10*BV | HTI 5 | \$ 335 | Y | 14 | 28 | 14 | Y |

DVP Components-MultiPk - Firestop/Straps/Support

| | | Disc. Code | MSRP USD | 004 IA | 010 PA | 014 CA | 016 NC | EXP |
|---------|-------------------------------------|---------------|-------------|-----------|-----------|-----------|-----------|-----|
| DVP-FSM | Ceiling firestop (multi-pack of 10) | HTI 1 | \$ 573 | Y | Y | Y | Y | Y |

DVP Components-MultiPk - Shield/Flashing/Collars

| | | Disc. Code | MSRP USD | 004 IA | 010 PA | 014 CA | 016 NC | EXP |
|---------|---------------------------|---------------|-------------|-----------|-----------|-----------|-----------|-----|
| DVP-WSM | DVP Wall Shield (6 piece) | HTI 1 | \$ 573 | Y | 21 | 14 | 14 | Y |

DVP Components-SinglePk - Elbow

| | | Disc. Code | MSRP USD | 004 IA | 010 PA | 014 CA | 016 NC | EXP |
|---------|-----------------|---------------|-------------|-----------|-----------|-----------|-----------|-----|
| DVP45 | 45 Degree elbow | HTI 1 | \$ 144 | Y | Y | Y | Y | Y |
| DVP90ST | 90 Degree elbow | HTI 1 | \$ 150 | Y | Y | Y | Y | Y |

DVP Components-SinglePk - Firestop/Straps/Support

| | | Disc. Code | MSRP USD | 004 IA | 010 PA | 014 CA | 016 NC | EXP |
|---------|-------------------------|---------------|-------------|-----------|-----------|-----------|-----------|-----|
| DVP-HVS | Horizontal pipe support | HTI 1 | \$ 50 | Y | Y | 14 | 14 | Y |
| DVP-FS | Ceiling firestop | HTI 1 | \$ 70 | Y | Y | Y | Y | Y |
| DVP-WS | Wall Firestop | HTI 1 | \$ 96 | Y | Y | Y | Y | Y |

DVP Components-SinglePk - Shield/Flashing/Collars

| | | Disc. Code | MSRP USD | 004 IA | 010 PA | 014 CA | 016 NC | EXP |
|----------|---|---------------|-------------|-----------|-----------|-----------|-----------|-----|
| UNIV-AS2 | Attic insulation shield (firestop not included) | HTI 1 | \$ 54 | Y | Y | Y | Y | Y |
| DVP-RDS | Roof Deck Underside Insulation Shield | HTI 1 | \$ 270 | 8 | 21 | Y | 14 | Y |

DVP Components-SinglePk - Straight Section

| | | Disc. Code | MSRP USD | 004 IA | 010 PA | 014 CA | 016 NC | EXP |
|--------|---|---------------|-------------|-----------|-----------|-----------|-----------|-----|
| DVP4 | 4" (102mm) length of double wall | HTI 1 | \$ 77 | Y | Y | Y | Y | Y |
| DVP6 | 6" (152mm) length of double wall | HTI 1 | \$ 86 | Y | Y | Y | Y | Y |
| DVP6A | 3 - 6" (76-152mm) slip section to slide over pipe (can be cut to length) | HTI 1 | \$ 92 | Y | Y | Y | Y | Y |
| DVP12 | 12" (305mm) length of double wall | HTI 1 | \$ 119 | Y | Y | Y | Y | Y |
| DVP12A | 3 - 12" (76-305mm) slip section to slide over pipe (can be cut to length) | HTI 1 | \$ 124 | Y | Y | Y | Y | Y |
| DVP24 | 24" (610mm) length of double wall | HTI 1 | \$ 126 | Y | Y | Y | Y | Y |
| DVP36 | 36" (914mm) length of double wall | HTI 1 | \$ 136 | Y | Y | Y | Y | Y |
| DVP48 | 48" (1219mm) length of double wall | HTI 1 | \$ 193 | Y | Y | Y | Y | Y |

DVP Termination Kits - Multi Pk - Brick Extension

| | | Disc. Code | MSRP USD | 004 IA | 010 PA | 014 CA | 016 NC | EXP |
|----------|--|---------------|-------------|-----------|-----------|-----------|-----------|-----|
| BEK | Brick extension kit, 14" x 14" (multi-pack of 10) | HTI 1 | \$ 779 | 8 | 21 | 14 | 14 | N |
| DVP-BEK2 | Brick extension kit, 12" x 14" (multi-pack of 10)(box quantities only) | HTI 1 | \$ 844 | Y | Y | 14 | Y | Y |

DVP Termination Kits - Multi Pk - Shield/Flashing/Collars

| | | Disc. Code | MSRP USD | 004 IA | 010 PA | 014 CA | 016 NC | EXP |
|------------|---|---------------|-------------|-----------|-----------|-----------|-----------|-----|
| DVP-TRAPFL | Trap cap rain flashing (multi-pack of 4) | HTI 1 | \$ 125 | Y | Y | Y | Y | Y |
| DVP-HSM-B | 26" (660mm) trimmable heat shield (multi-pack of 6) | HTI 1 | \$ 205 | Y | 21 | 14 | 14 | Y |

DVP Termination Kits - Single Pk - Shield/Flashing/Collars

| | | Disc. Code | MSRP USD | 004 IA | 010 PA | 014 CA | 016 NC | EXP |
|----------|--------------------------|---------------|-------------|-----------|-----------|-----------|-----------|-----|
| TRAP-LV | Top Louver for Trap Caps | HTI 1 | \$ 25 | 8 | 14 | 14 | 14 | Y |
| TRAP-VSS | Vinyl siding shield | HTI 1 | \$ 26 | Y | Y | Y | Y | Y |
| VPK-DV | Vinyl protector kit | HTI 1 | \$ 111 | 14 | 14 | 14 | 14 | Y |

DVP Termination Kits - Single Pk - Termination

| | | Disc. Code | MSRP USD | 004 IA | 010 PA | 014 CA | 016 NC | EXP |
|---------------|---|---------------|-------------|-----------|-----------|-----------|-----------|-----|
| DVP-TV | Vertical direct vent termination cap, with storm collar | HTI 1 | \$ 310 | Y | Y | Y | Y | Y |
| DVP-TRAP1 | Horizontal termination cap with short flue, attached slip and wall shield with heat shield, 3-1/8" - 4-5/8" (79-117mm) | HTI 1 | \$ 324 | Y | Y | Y | Y | Y |
| DVP-TVHW | Vertical termination cap - high wind (includes 18901 storm collar) | HTI 1 | \$ 324 | Y | Y | Y | Y | Y |
| DVP-TRAP2 | Horizontal termination cap with long flue, attached slip and wall shield with heat shield, 5-3/8" - 9-3/8" (137 -238mm) | HTI 1 | \$ 324 | Y | Y | Y | Y | Y |
| DVP-HPC2 | Horizontal high performance termination cap (long flue with attached slip, and wall shield with heat shield) | HTI 1 | \$ 383 | Y | Y | Y | 14 | Y |
| DVP-HPC1 | High performance termination cap (short flue with attached slip, and wall shield with heat shield) | HTI 1 | \$ 383 | Y | 21 | 14 | 14 | Y |
| DVP-TRAPK2 | Horizontal termination kit (includes DVP-TRAP2, slip section, wall shield and DVP90ST) | HTI 1 | \$ 439 | Y | Y | Y | Y | Y |
| DVP-TRAPK1 | Horizontal termination kit (includes DVP-TRAP1, slip section, wall shield and DVP90ST) | HTI 1 | \$ 439 | Y | Y | Y | 14 | Y |
| DVP-HRC-ZC-SS | Horizontal high rise termination cap, glass termination base, DVP pipe (stainless steel) | HTI 1 | \$ 511 | 8 | 21 | 14 | 14 | Y |
| DVP-HRC-SS | Horizontal high rise termination cap, standard base, DVP pipe (stainless steel) | HTI 1 | \$ 511 | 8 | 21 | 14 | 14 | Y |
| DVP-TB1 | Horizontal snorkel cap for basement applications | HTI 1 | \$ 522 | Y | 21 | 14 | 14 | Y |

Roof Flashing

| | | Disc. Code | MSRP USD | 004 IA | 010 PA | 014 CA | 016 NC | EXP |
|------|--|---------------|-------------|-----------|-----------|-----------|-----------|-----|
| RF6 | Roof flashing, 0/12 - 6/12 roof pitch | HTI 1 | \$ 172 | Y | Y | Y | Y | Y |
| RF12 | Roof flashing, 7/12 - 12/12 roof pitch | HTI 1 | \$ 210 | Y | Y | Y | Y | Y |

SLP Flex Pipe - Components

| | | Disc. Code | MSRP USD | 004 IA | 010 PA | 014 CA | 016 NC | EXP |
|-------------|--|---------------|-------------|-----------|-----------|-----------|-----------|-----|
| SLP-FLEX-3 | 3' (914mm) SL pipe length - flexible venting | HTI 1 | \$ 171 | Y | 21 | 21 | 14 | N |
| SLP-FLEX-5 | 5' (1524mm) SL pipe length - flexible venting | HTI 1 | \$ 226 | Y | Y | Y | 21 | N |
| SLP-FLEX-10 | 10' (3048mm) SL pipe length - flexible venting | HTI 1 | \$ 324 | Y | 21 | Y | 14 | Y |

SLP Flex Pipe - Termination Kits

| | | Disc. Code | MSRP USD | 004 IA | 010 PA | 014 CA | 016 NC | EXP |
|-----------------|--|---------------|-------------|-----------|-----------|-----------|-----------|-----|
| SLP-FLEX-TRAP | Trapezoid termination kit (includes cap and wall thimble) | HTI 1 | \$ 411 | Y | 14 | Y | 21 | N |
| SLP-FLEXTRAP30B | Trapezoid termination kit (includes 24" of flex, trap cap with 6" collar and firestop) | HTI 1 | \$ 511 | Y | 21 | Y | 14 | Y |

Decorative Shroud B-Vent - Termination

| | | Disc. Code | MSRP USD | 004 IA | 010 PA | 014 CA | 016 NC | EXP |
|--------|---------------------------------------|---------------|-------------|-----------|-----------|-----------|-----------|-----|
| LDS-BV | Decorative shroud for 5" or 6" B-vent | HTI 1 | \$ 352 | Y | 21 | 14 | Y | Y |

Decorative Shrouds for Direct Vent - Shroud

| | | Disc. Code | MSRP USD | 004 IA | 010 PA | 014 CA | 016 NC | EXP |
|------------|--|---------------|-------------|-----------|-----------|-----------|-----------|-----|
| DRC-RADIUS | Decorative radius cover for SLP/DVP-TRAP | HTI 1 | \$ 310 | Y | Y | Y | Y | Y |

Shrouds for Gas Units - Shroud

| | | Disc. Code | MSRP USD | 004 IA | 010 PA | 014 CA | 016 NC | EXP |
|-----------|--|---------------|-------------|-----------|-----------|-----------|-----------|-----|
| TCG375 | Vertical terra cotta termination cap cover (for DV and BV units) | HTI 1 | \$ 522 | Y | 14 | 14 | 14 | N |
| COOL-ADDM | Safety shields for horizontal termination caps (multi-pack of 6) | HTI 1 | \$ 595 | Y | Y | 14 | Y | Y |

SLP - Black - Collar

| | | Disc. Code | MSRP USD | 004 IA | 010 PA | 014 CA | 016 NC | EXP |
|------------|--|---------------|-------------|-----------|-----------|-----------|-----------|-----|
| STOVEDV-BK | Stove collar for DuraVent pipe - Black | HTI 3 | \$ 78 | Y | 14 | Y | 14 | Y |

SLP - Black - Decorative

| | | Disc. Code | MSRP USD | 004 IA | 010 PA | 014 CA | 016 NC | EXP |
|------------|---------------------------------------|---------------|-------------|-----------|-----------|-----------|-----------|-----|
| SLP-WT-BK | Decorative wall thimble cover - Black | HTI 3 | \$ 104 | Y | Y | Y | 14 | Y |
| SLP-DCF-BK | Decorative ceiling firestop - Black | HTI 3 | \$ 109 | Y | 14 | Y | 14 | Y |
| SLP-CCS-BK | Cathedral ceiling support - Black | HTI 3 | \$ 160 | Y | Y | Y | 14 | Y |

SLP - Black - Elbow

| | | Disc. Code | MSRP USD | 004 IA | 010 PA | 014 CA | 016 NC | EXP |
|----------|-------------------------|---------------|-------------|-----------|-----------|-----------|-----------|-----|
| SLP45-BK | 45 Degree elbow - Black | HTI 3 | \$ 124 | Y | Y | Y | 14 | Y |
| SLP90-BK | 90 Degree elbow - Black | HTI 3 | \$ 124 | Y | Y | Y | 14 | Y |

SLP - Black - Single-Pack - Adapter

| | | Disc. Code | MSRP USD | 004 IA | 010 PA | 014 CA | 016 NC | EXP |
|--------|---------------|---------------|-------------|-----------|-----------|-----------|-----------|-----|
| SLP-SA | Stove adapter | HTI 1 | \$ 18 | Y | 14 | 14 | 14 | Y |

SLP - Black - Straight Section

| | | Disc. Code | MSRP USD | 004 IA | 010 PA | 014 CA | 016 NC | EXP |
|-----------|--|---------------|-------------|-----------|-----------|-----------|-----------|-----|
| SLP6A-BK | 2" - 6" (51 - 152mm) slip section to slide over pipe (can be cut to length) - Black | HTI 3 | \$ 71 | Y | Y | Y | 14 | Y |
| SLP4-BK | 4" (102mm) pipe length - Black | HTI 3 | \$ 72 | Y | 14 | 14 | 14 | Y |
| SLP12A-BK | 2" - 12" (51 - 305mm) slip section to slide over pipe (can be cut to length) - Black | HTI 3 | \$ 76 | Y | Y | Y | 14 | Y |
| SLP6-BK | 6" (152mm) pipe length - Black | HTI 3 | \$ 79 | Y | Y | Y | 14 | Y |
| SLP12-BK | 12" (305mm) pipe length - Black | HTI 3 | \$ 88 | Y | Y | Y | 21 | Y |
| SLP24-BK | 24" (610mm) pipe length - Black | HTI 3 | \$ 116 | Y | Y | Y | 14 | Y |
| SLP36-BK | 36" (914mm) pipe length - Black | HTI 3 | \$ 134 | Y | Y | Y | 14 | Y |
| SLP48-BK | 48" (1219mm) pipe length - Black | HTI 3 | \$ 179 | Y | Y | Y | 14 | Y |

SLP - Black - Termination

| | | Disc. Code | MSRP USD | 004 IA | 010 PA | 014 CA | 016 NC | EXP |
|------------|--|---------------|-------------|-----------|-----------|-----------|-----------|-----|
| LINK-STOVE | Stove adapter kit (includes 30' of 4" flex, adapters, wall thimble, masonry, and ZC flashing, 991DA cap and fasteners) | HTI 1 | \$ 549 | Y | Y | 28 | 14 | N |
| SLP-SK-BK | Horizontal trapezoid termination kit (includes 1 each CCSLP, SLP-HHW2, SLP-WT-BK, SLP24-BK, SLP6-BK, SLP6A-BK, SLP90-BK) | HTI 1 | \$ 799 | Y | Y | 14 | 14 | Y |

SLP - Components - Single-Pack - Elbow

| | | Disc. Code | MSRP USD | 004 IA | 010 PA | 014 CA | 016 NC | EXP |
|-------|-----------------|---------------|-------------|-----------|-----------|-----------|-----------|-----|
| SLP45 | 45 Degree elbow | HTI 1 | \$ 129 | Y | Y | Y | Y | Y |
| SLP90 | 90 Degree elbow | HTI 1 | \$ 131 | Y | Y | Y | Y | Y |

SLP - Components - Single-Pack - Firestop/Straps/Support

| | | Disc. Code | MSRP USD | 004 IA | 010 PA | 014 CA | 016 NC | EXP |
|---------|--------------------------------|---------------|-------------|-----------|-----------|-----------|-----------|-----|
| SLP-FS | Ceiling firestop | HTI 1 | \$ 53 | Y | Y | Y | Y | Y |
| SLP-WS | Wall firestop | HTI 1 | \$ 61 | Y | Y | Y | Y | Y |
| SLP-HVS | Horizontal vent support hanger | HTI 1 | \$ 66 | Y | Y | 14 | 14 | Y |

SLP - Components - Single-Pack - Shield/Flashing/Collars

| | | Disc. Code | MSRP USD | 004 IA | 010 PA | 014 CA | 016 NC | EXP |
|----------|---------------------------------------|---------------|-------------|-----------|-----------|-----------|-----------|-----|
| SLP-RF6 | 0/12 - 6/12 roof flashing | HTI 1 | \$ 87 | Y | Y | Y | Y | Y |
| SLP-RF12 | 7/12-12/12 roof flashing | HTI 1 | \$ 131 | Y | Y | Y | Y | Y |
| SLP-RDS | Roof Deck Underside Insulation Shield | HTI 1 | \$ 270 | 8 | 21 | Y | 14 | Y |

SLP - Components - Single-Pack - Straight Section

| | | Disc. Code | MSRP USD | 004 IA | 010 PA | 014 CA | 016 NC | EXP |
|-----------|--|---------------|-------------|-----------|-----------|-----------|-----------|-----|
| SLP6A | 2" - 6" (51 - 152mm) slip section to slide over pipe (can be cut to length) | HTI 1 | \$ 66 | Y | Y | Y | Y | Y |
| SLP6 | 6" (152mm) pipe length | HTI 1 | \$ 69 | Y | Y | Y | Y | Y |
| SLP4 | 4" (102mm) pipe length | HTI 1 | \$ 69 | Y | Y | Y | Y | Y |
| SLP12A | 2" - 12" (51 - 305mm) slip section to slide over pipe (can be cut to length) | HTI 1 | \$ 81 | Y | Y | Y | Y | Y |
| SLP12 | 12" (305mm) pipe length | HTI 1 | \$ 96 | Y | Y | Y | Y | Y |
| DVP-2SL | DVP to SLP adapter converts 8 inch to 6-5/8 | HTI 1 | \$ 104 | Y | Y | Y | Y | N |
| SLP24 | 24" (610mm) pipe length | HTI 1 | \$ 112 | Y | Y | Y | Y | Y |
| DVP-SLP24 | DVP to SLP 24" (640mm) pipe length adapter | HTI 1 | \$ 123 | Y | Y | Y | Y | Y |
| SLP36 | 36" (914mm) pipe length | HTI 1 | \$ 123 | Y | Y | Y | Y | Y |
| SL-2DVP | SLP to DVP adapter | HTI 1 | \$ 153 | Y | Y | Y | 14 | N |
| SLP48 | 48" (1219mm) pipe length | HTI 1 | \$ 162 | Y | Y | Y | Y | Y |

SLP - Term Kits & Acc - Single Pack - Termination

| | | Disc. Code | MSRP USD | 004 IA | 010 PA | 014 CA | 016 NC | EXP |
|------------|--|---------------|-------------|-----------|-----------|-----------|-----------|-----|
| SLP-TVHW | Vertical termination cap - high wind (includes 4071-004 storm collar) | HTI 1 | \$ 205 | Y | Y | Y | Y | Y |
| SLP-TRAP2 | Horizontal trapezoid termination Kit 5-1/4 - 9-1/4" (133-235mm) wall thickness | HTI 1 | \$ 324 | Y | Y | Y | Y | Y |
| SLP-TRAP1 | Horizontal trapezoid termination short flue 3-1/8 -4-3/4" (79-121mm), includes SLP-WS | HTI 1 | \$ 324 | Y | Y | Y | 14 | Y |
| SLP-HHW2 | Horizontal high wind trapezoid termination (includes 1 - SLP-WS) | HTI 1 | \$ 401 | Y | 21 | Y | 14 | Y |
| SLP-TRAPK1 | Top vent horizontal term kit #1 (includes SLP-TRAP1, slip section, wall shield, SLP90) | HTI 1 | \$ 439 | Y | 21 | Y | 14 | Y |
| SLP-TRAPK2 | Top vent horizontal term kit #2 (includes SLP-TRAP2, slip section, wall shield, SLP90) | HTI 1 | \$ 439 | Y | Y | Y | Y | Y |
| SLP-HRC-SS | Horizontal high-rise termination - stainless steel (includes 1 - SLP-WS) | HTI 1 | \$ 465 | Y | 21 | 14 | 14 | Y |
| SLP-TB1 | Horizontal snorkel cap for basement applications | HTI 1 | \$ 522 | Y | 21 | 14 | 14 | Y |
| SLK-SNKD | SL snorkel cap, adds 14" vertical rise (includes firestop) | HTI 1 | \$ 629 | 35 | Y | Y | 14 | N |

Gas Insert Venting - 30/30 Termination Kits

| | | Disc. Code | MSRP USD | 004 IA | 010 PA | 014 CA | 016 NC | EXP |
|----------------|--|---------------|-------------|-----------|-----------|-----------|-----------|-----|
| LINK-DV4-30B | Direct vent insert kit - one 4 - liner, one 30 - liner, plus term cap components | HTI 1 | \$ 549 | Y | Y | Y | Y | Y |
| LINK-DV30B | Direct vent insert kit - two 30 - liners, plus term cap components | HTI 1 | \$ 649 | Y | Y | Y | Y | Y |
| LINKSQB-DV4-30 | Direct vent insert kit - one 4 - liner, one 30 - liner, plus black term cap components | HTI 1 | \$ 649 | Y | Y | 14 | 14 | Y |
| LINKSQB-DV30 | Direct vent insert kit - two 30 - liners, plus black term cap components | HTI 1 | \$ 729 | Y | Y | Y | 14 | Y |
| LINKSQC-DV30 | Direct vent insert kit - two 30" liners, plus faux copper term cap components | HTI 1 | \$ 789 | Y | Y | Y | 14 | Y |

Gas Insert Venting - Components

| | | Disc. Code | MSRP USD | 004 IA | 010 PA | 014 CA | 016 NC | EXP |
|--------------|---|---------------|-------------|-----------|-----------|-----------|-----------|-----|
| 95070310 | BD Flex liner 3x10 aluminum | HTI 4 | \$ 71 | Y | 21 | 14 | 14 | N |
| FLEX-CNCT | Connector kit -- 3" liner to 3" liner (1 connector per kit) | HTI 1 | \$ 72 | Y | Y | 14 | 14 | Y |
| LINK-ZC-ADPB | 14 1/2" round flashing adapter kit (for use with existing liner kits when using Class A pipe) | HTI 1 | \$ 90 | Y | Y | 14 | 14 | Y |
| FLEX3-30 | One 3" flexible liner (expands to 30') | HTI 1 | \$ 143 | Y | 14 | 21 | 21 | N |
| 95070325 | BD Flex liner 3x25 aluminum | HTI 4 | \$ 164 | Y | 14 | | | N |
| DV-46DVA-GCL | Colinear adapter for stoves with SLP coaxial outlets | HTI 5 | \$ 320 | Y | 14 | 28 | 14 | N |
| DV-46DVA-GK | Adapter kit - colinear 3" to direct vent pipe to extend the run | HTI 5 | \$ 345 | Y | 14 | 28 | 14 | N |

Insulated Flex Duct - Chimney Air Kits/Flex Duct

| | | Disc. Code | MSRP USD | 004 IA | 010 PA | 014 CA | 016 NC | EXP |
|-----|--|---------------|-------------|-----------|-----------|-----------|-----------|-----|
| ID4 | 4" (100mm) insulated flex duct for outside air - includes two 42" (1065mm) sections | HTI 1 | \$ 87 | Y | Y | 14 | Y | Y |
| ID6 | 6" (152mm) insulated flex duct for use with outside air kit - includes two 42" (1065mm) sections | HTI 1 | \$ 100 | Y | Y | Y | Y | Y |

Outside Air Kit

| | | Disc. Code | MSRP USD | 004 IA | 010 PA | 014 CA | 016 NC | EXP |
|---------|--|---------------|-------------|-----------|-----------|-----------|-----------|-----|
| OA-RD-6 | Outside air elbow kit (used to offset outside air starting collar) | HTI 1 | \$ 60 | Y | 14 | 14 | 14 | Y |
| OAK-ACC | ACC outside air kit | HTI 4 | \$ 67 | Y | Y | Y | 21 | Y |
| AK22 | Outside air kit - (flex not included) | HTI 1 | \$ 70 | Y | Y | Y | Y | Y |
| AKD | Outside Combustion Air Kit with Access Door | MON 1 | \$ 76 | Y | 21 | 14 | Y | Y |
| OAK-3 | Outside air kit | HTI 4 | \$ 139 | Y | Y | Y | 21 | Y |
| AK-TV | Outside air kit - (25" un-insulated flex duct included) | HTI 1 | \$ 189 | 14 | 21 | 14 | 14 | Y |

Uninsulated Flex Duct - Chimney Air Kits/Flex Duct

| | | Disc. Code | MSRP USD | 004 IA | 010 PA | 014 CA | 016 NC | EXP |
|-----|--|---------------|-------------|-----------|-----------|-----------|-----------|-----|
| UD4 | 4" (100mm) uninsulated flex duct for outside air - includes two 42" (1065mm) sections | HTI 1 | \$ 56 | Y | Y | Y | Y | Y |
| UD6 | 6" (152mm) uninsulated flex duct for use with outside air kit - includes two 42" (1065mm) sections | HTI 1 | \$ 71 | Y | 14 | 14 | 14 | Y |

SLP and DVP - Shield/Flashing/Collars

| | | Disc. Code | MSRP USD | 004 IA | 010 PA | 014 CA | 016 NC | EXP |
|-----------|--|---------------|-------------|-----------|-----------|-----------|-----------|-----|
| UNIV-AS2M | Attic shield (multi-pack of 6) (firestop not included) | HTI 1 | \$ 226 | Y | Y | Y | Y | Y |

3" Pellet Vent Pro - Adapter/Incraser/Tee

| | | Disc. Code | MSRP USD | 004 IA | 010 PA | 014 CA | 016 NC | EXP |
|----------------|---|---------------|-------------|-----------|-----------|-----------|-----------|-----|
| DV-3PVP-AD | 3" PV Appliance Adapter | HTI 5 | \$ 40 | Y | Y | Y | 14 | N |
| DV-3PVP-ADFF | 3" PV Female Flex Adapter | HTI 5 | \$ 51 | 35 | 35 | 28 | 35 | N |
| DV-3PVP-ADB | 3" PV Appliance Adapter Black | HTI 5 | \$ 60 | | 14 | 28 | 35 | N |
| DV-3PVP-ADHB | 3" PV pipe adapter | HTI 5 | \$ 61 | Y | 14 | Y | 14 | N |
| DV-3PVP-ADFM | 3" PV Male Flex Adapter | HTI 5 | \$ 70 | 35 | 35 | 28 | 35 | N |
| DV-3PVP-12A | 12" Pipe Extension | HTI 5 | \$ 100 | Y | Y | 28 | 14 | N |
| DV-3PVP-X4 | Incraser 3" - 4" | HTI 5 | \$ 126 | 35 | 35 | 28 | 35 | N |
| DV-3PVP-X4AD | Appliance Adapter/Incraser 3" - 4" | HTI 5 | \$ 146 | 35 | 35 | 28 | 35 | N |
| DV-3PVP-X6 | Chimney Adapter - 6" | HTI 5 | \$ 178 | 35 | 35 | 28 | 35 | N |
| DV-3PVP-X4ADHB | Appliance Adapter/Incraser 3" - 4" | HTI 5 | \$ 191 | 35 | 35 | 28 | 35 | N |
| DV-3PVP-X4ADB | Appliance Adapter/Incraser 3" - 4" (black) | HTI 5 | \$ 191 | 35 | 35 | 28 | 35 | N |
| DV-3PVP-X8 | Chimney Adapter - 8" | HTI 5 | \$ 219 | 35 | 35 | 28 | 35 | N |
| DV-3PVP-TADB | 3" PV Adapter Tee w/Clean-Out Tee Cap (black) | HTI 5 | \$ 239 | 35 | 35 | 28 | 35 | N |

3" Pellet Vent Pro - Adapter/Incraser/Tee

| | | Disc. Code | MSRP USD | 004 IA | 010 PA | 014 CA | 016 NC | EXP |
|-----------------|--------------------------|---------------|-------------|-----------|-----------|-----------|-----------|-----|
| DV-3PVP-CO1 | 3" CLEAN OUT TEE CAP | HTI 5 | \$ 82 | 35 | 35 | 28 | 35 | Y |
| DV-3PVP-INC | 2IN-3IN INCRASER | HTI 5 | \$ 92 | 35 | 35 | 28 | 35 | Y |
| DV-3PVP-HC2 | HORIZONTAL CAP | HTI 5 | \$ 92 | Y | Y | Y | 14 | Y |
| DV-3PVP-COB1 | End cap for 3" pellet T | HTI 5 | \$ 95 | 35 | 35 | 28 | 35 | Y |
| DV-3PVP-T1 | SNG TEE/CLEAN OUT CAP | HTI 5 | \$ 218 | Y | Y | Y | 14 | Y |
| DV-3PVP-TAD1 | ADPTR TEE W/ CO CAP | HTI 5 | \$ 218 | 35 | 35 | 28 | 35 | Y |
| DV-3PVP-TADX41 | 3-4 INCRS ADPT TEE | HTI 5 | \$ 232 | 35 | 35 | 28 | 35 | Y |
| DV-3PVP-TB1 | BLK SNG TEE W/ CLEAN OUT | HTI 5 | \$ 237 | Y | 14 | 28 | 14 | Y |
| DV-3PVP-TADX4B1 | 3-4 INCRS ADPT TEE BLACK | HTI 5 | \$ 252 | 35 | 35 | 28 | 35 | Y |
| DV-3PVP-DBTB1 | BLK DBL TEE W/ CLEAN OUT | HTI 5 | \$ 425 | 35 | 35 | 28 | 35 | Y |
| DV-3PVP-DBT1 | DBL TEE W/ CLEAN OUT CAP | HTI 5 | \$ 425 | 35 | 35 | 28 | 35 | Y |

3" Pellet Vent Pro - Anchor

| | | Disc. Code | MSRP USD | 004 IA | 010 PA | 014 CA | 016 NC | EXP |
|-------------|-----------------------------|---------------|-------------|-----------|-----------|-----------|-----------|-----|
| DV-3PVP-WS | 3" PV Wall Strap | HTI 5 | \$ 50 | 35 | 35 | 28 | 35 | N |
| DV-3PVP-WSA | 3" PV Adjustable Wall Strap | HTI 5 | \$ 55 | 35 | 14 | Y | 14 | N |

3" Pellet Vent Pro - Elbow

| | | Disc. Code | MSRP USD | 004 IA | 010 PA | 014 CA | 016 NC | EXP |
|--------------|-------------------------------|---------------|-------------|-----------|-----------|-----------|-----------|-----|
| DV-3PVP-E45 | 3" PV 45 Degree Elbow | HTI 5 | \$ 130 | Y | Y | 28 | 14 | N |
| DV-3PVP-E45B | 3" PV 45 Degree Elbow (black) | HTI 5 | \$ 145 | Y | 14 | 28 | 14 | N |
| DV-3PVP-E90 | 3" PV 90 Degree Elbow | HTI 5 | \$ 163 | Y | Y | Y | 14 | Y |
| DV-3PVP-E90B | 3" PV 90 Degree Elbow (black) | HTI 5 | \$ 183 | Y | Y | 28 | 14 | N |

3" Pellet Vent Pro - Kit

| | | Disc. Code | MSRP USD | 004 IA | 010 PA | 014 CA | 016 NC | EXP |
|-------------|--|---------------|-------------|-----------|-----------|-----------|-----------|-----|
| DV-3PVP-AIK | 3" - 4" PelletVent Pro Fresh Air Intake Kit (includes: faceplate w/screen, moisture barrier, aluminum flex, [2] clamp) Made for 3-inch exhaust outlets with 2-inch air inlets. Not for use with Harman products. | HTI 5 | \$ 110 | 35 | 35 | 28 | 35 | N |
| DV-3PVP-WTI | 3" Wall Thimble Air Intake Kit (includes: Wall Thimble [for 1" clearance]; 2" AL Flex; [2] hose clamps) | HTI 5 | \$ 325 | Y | Y | 28 | 35 | N |
| DV-3PVP-KHA | 3" PelletVent Pro Horizontal Kit (includes: Round Horizontal Cap, Wall Thimble [for 1" clearance], Appliance Adapter [black]) | HTI 5 | \$ 389 | 35 | 35 | 28 | 35 | N |
| DV-3PVP-KVA | 3" PelletVent Pro Vertical Kit - Flat Ceiling (includes: Vertical Cap, Storm Collar, Ceiling Support Firestop Spacer [for 1" clearance], Adjustable Flashing, Appliance Adapter [black]) | HTI 5 | \$ 517 | 35 | 35 | 28 | 35 | N |

3" Pellet Vent Pro - Shield/Flashing/Collars

| | | Disc. Code | MSRP USD | 004 IA | 010 PA | 014 CA | 016 NC | EXP |
|-----------------|--|---------------|-------------|-----------|-----------|-----------|-----------|-----|
| DV-3PVP-SC | 3" PV Storm Collar | HTI 5 | \$ 13 | 35 | 35 | 35 | 14 | N |
| DV-3PVP-WSA-EXT | 3" PV Wall Strap Extension | HTI 5 | \$ 27 | 35 | 35 | 28 | 35 | N |
| DV-3PVP-F6 | 3" PV Adjustable Roof Flashing 0/12-6/12 | HTI 5 | \$ 42 | 35 | 35 | Y | 35 | N |
| DV-3PVP-RC | 3" PV Reduction Collar | HTI 5 | \$ 45 | 35 | 35 | 28 | 35 | N |
| DV-3PVP-FF | 3" PV Tall Cone Roof Flashing | HTI 5 | \$ 56 | 35 | 35 | 28 | 35 | N |
| DV-3PVP-F6DS | 3" PV DSA Roof Flashing 0/12 - 6/12 | HTI 5 | \$ 111 | 35 | 35 | 28 | 35 | N |
| DV-3PVP-IS | 3" PV Attic Insulation Shield | HTI 5 | \$ 112 | 35 | 35 | 28 | 35 | N |
| DV-3PVP-F12DS | 3" PV DSA Roof Flashing 7/12 - 12/12 | HTI 5 | \$ 121 | 35 | 35 | 28 | 35 | N |
| DV-3PVP-WT | Wall Thimble (for 1" clearance) | HTI 5 | \$ 139 | Y | Y | Y | 14 | N |
| DV-3PVP-FTC | 3" PV Flex Trim Collar | HTI 5 | \$ 139 | 35 | 35 | 28 | 35 | N |

3" Pellet Vent Pro - Straight Section

| | | Disc. Code | MSRP USD | 004 IA | 010 PA | 014 CA | 016 NC | EXP |
|--------------|----------------------------------|---------------|-------------|-----------|-----------|-----------|-----------|-----|
| DV-3PVP-06 | 6" Straight Length Pipe | HTI 5 | \$ 52 | Y | Y | Y | 14 | N |
| DV-3PVP-06B | 6" Straight Length Pipe (black) | HTI 5 | \$ 73 | Y | Y | 28 | 14 | N |
| DV-3PVP-12 | 12" Straight Length Pipe | HTI 5 | \$ 74 | Y | Y | Y | 14 | Y |
| DV-3PVP-12B | 12" Straight Length Pipe (black) | HTI 5 | \$ 97 | Y | Y | 28 | 14 | N |
| DV-3PVP-24 | 24" Straight Length Pipe | HTI 5 | \$ 98 | 35 | Y | Y | 14 | N |
| DV-3PVP-12AB | 12" Pipe Extension (black) | HTI 5 | \$ 120 | Y | 14 | 28 | 14 | N |
| DV-3PVP-24B | 24" Straight Length Pipe (black) | HTI 5 | \$ 121 | Y | Y | 28 | 14 | N |
| DV-3PVP-36 | 36" Straight Length Pipe | HTI 5 | \$ 134 | Y | Y | Y | 14 | N |
| DV-3PVP-36B | 36" Straight Length Pipe (black) | HTI 5 | \$ 151 | Y | 14 | 28 | 14 | N |
| DV-3PVP-18A | 18" Pipe Extension | HTI 5 | \$ 154 | 35 | 35 | 28 | 35 | N |
| DV-3PVP-18AB | 18" Pipe Extension (black) | HTI 5 | \$ 184 | Y | 14 | 28 | 14 | N |
| DV-3PVP-60 | 60" Straight Length Pipe | HTI 5 | \$ 191 | | | Y | 14 | N |
| DV-3PVP-60B | 60" Straight Length Pipe (black) | HTI 5 | \$ 226 | 35 | 14 | 28 | 14 | N |
| DV-3PVP-60F | 60" Flex Pipe | HTI 5 | \$ 328 | 35 | 35 | 28 | 35 | N |

3" Pellet Vent Pro - Straps/Support

| | | Disc. Code | MSRP USD | 004 IA | 010 PA | 014 CA | 016 NC | EXP |
|-------------|--|---------------|-------------|-----------|-----------|-----------|-----------|-----|
| DV-3PVP-FS | 3" PV Ceiling Support Firestop Spacer (for 1" clearance) | HTI 5 | \$ 107 | 35 | 35 | 28 | 35 | N |
| DV-3PVP-WTC | Ceiling Support/Wall Thimble Cover | HTI 5 | \$ 115 | 35 | 35 | 28 | 35 | N |
| DV-3PVP-CS | 3" PV Cathedral Ceiling Support Box | HTI 5 | \$ 221 | 35 | 35 | 28 | 35 | N |

3" Pellet Vent Pro - Termination

| | | Disc. Code | MSRP USD | 004 IA | 010 PA | 014 CA | 016 NC | EXP |
|-------------|-----------------------------|---------------|-------------|-----------|-----------|-----------|-----------|-----|
| DV-3PVP-HSC | 3" PV Square Horizontal Cap | HTI 5 | \$ 107 | 35 | 14 | 28 | 14 | N |
| DV-3PVP-VC | 3" PV Vertical Cap | HTI 5 | \$ 121 | 35 | Y | 35 | 14 | N |

4" Pellet Vent Pro - Anchor

| | | Disc. Code | MSRP USD | 004 IA | 010 PA | 014 CA | 016 NC | EXP |
|-------------|-----------------------------|---------------|-------------|-----------|-----------|-----------|-----------|-----|
| DV-4PVP-WS | 4" PV Wall Strap | HTI 5 | \$ 54 | 35 | 35 | 28 | 35 | N |
| DV-4PVP-WSA | 4" PV Adjustable Wall Strap | HTI 5 | \$ 59 | 35 | 35 | 28 | 35 | N |

4" Pellet Vent Pro - Elbow

| | | Disc. Code | MSRP USD | 004 IA | 010 PA | 014 CA | 016 NC | EXP |
|--------------|-------------------------------|---------------|-------------|-----------|-----------|-----------|-----------|-----|
| DV-4PVP-E45 | 4" PV 45 Degree Elbow | HTI 5 | \$ 148 | Y | 14 | 28 | 14 | N |
| DV-4PVP-E45B | 4" PV 45 Degree Elbow (black) | HTI 5 | \$ 183 | 35 | 35 | 28 | 35 | N |
| DV-4PVP-E90 | 4" PV 90 Degree Elbow | HTI 5 | \$ 205 | Y | 14 | 28 | 14 | N |
| DV-4PVP-E90B | 4" PV 90 Degree Elbow (black) | HTI 5 | \$ 239 | 35 | 35 | 28 | 35 | N |

4" Pellet Vent Pro - Kit

| | | Disc. Code | MSRP USD | 004 IA | 010 PA | 014 CA | 016 NC | EXP |
|--------------|---|---------------|-------------|-----------|-----------|-----------|-----------|-----|
| DV-4PVP-WTI | 4" Wall Thimble Air Intake Kit (includes: Wall Thimble [for 1" clearance]; 2" AL Flex; [2] hose clamps) | HTI 5 | \$ 349 | 35 | 35 | 28 | 35 | N |
| DV-4PVP-KVAC | 4" PV Vertical kit | HTI 5 | \$ 449 | 35 | 35 | 28 | 35 | N |
| DV-4PVP-KHA | 4" PelletVent Pro Horizontal Kit (includes: Round Horizontal Cap, Wall Thimble [for 1" clearance], Appliance Adapter/Incraser 3" - 4" [black]) | HTI 5 | \$ 485 | 35 | 35 | 28 | 35 | N |
| DV-4PVP-KVA | 4" PelletVent Pro Vertical Kit - Flat Ceiling (includes: Vertical Cap, Storm Collar, Ceiling Support Firestop Spacer [for 1" clearance], Adjustable Flashing, Appliance Adapter/incraser 3" - 4" [black]) | HTI 5 | \$ 555 | 35 | 35 | 28 | 35 | N |

4" Pellet Vent Pro - Shield/Flashing/Collars

| | | Disc. Code | MSRP USD | 004 IA | 010 PA | 014 CA | 016 NC | EXP |
|-------------|---------------------------------------|---------------|-------------|-----------|-----------|-----------|-----------|-----|
| DV-4PVP-SC | 4" PV Storm Collar | HTI 5 | \$ 14 | 35 | 35 | 28 | 35 | N |
| DV-4PVP-RC | 4" PV Reduction Collar | HTI 5 | \$ 45 | 35 | 35 | 28 | 35 | N |
| DV-4PVP-F6 | 4" PV Adjustable Roof Flashing | HTI 5 | \$ 47 | 35 | 35 | 28 | 35 | N |
| DV-4PVP-IS | 4" PV Attic Insulation Shield | HTI 5 | \$ 112 | 35 | 35 | 28 | 35 | N |
| DV-4PVP-FTC | 4" PV Flex Trim Collar | HTI 5 | \$ 133 | 35 | 35 | 28 | 35 | N |
| DV-4PVP-WT | 4" PV Wall Thimble (for 1" clearance) | HTI 5 | \$ 149 | Y | 14 | 28 | 14 | N |

4" Pellet Vent Pro - Straight Section

| | | Disc. Code | MSRP USD | 004 IA | 010 PA | 014 CA | 016 NC | EXP |
|--------------|----------------------------------|---------------|-------------|-----------|-----------|-----------|-----------|-----|
| DV-4PVP-06 | 6" Straight Length Pipe | HTI 5 | \$ 55 | 35 | 14 | 28 | 14 | N |
| DV-4PVP-12 | 12" Straight Length Pipe | HTI 5 | \$ 79 | Y | 14 | 28 | 14 | N |
| DV-4PVP-06B | 6" Straight Length Pipe (black) | HTI 5 | \$ 90 | 35 | 35 | 28 | 35 | N |
| DV-4PVP-12A | 12" Pipe Extension | HTI 5 | \$ 111 | 35 | 35 | 28 | 35 | N |
| DV-4PVP-24 | 24" Straight Length Pipe | HTI 5 | \$ 123 | Y | 14 | 28 | 14 | N |
| DV-4PVP-12B | 12" Straight Length Pipe (black) | HTI 5 | \$ 125 | 35 | 35 | 28 | 35 | N |
| DV-4PVP-12AB | 12" Pipe Extension (black) | HTI 5 | \$ 157 | 35 | 35 | 28 | 35 | N |
| DV-4PVP-36 | 4" PV 36" Straight Length Pipe | HTI 5 | \$ 160 | Y | 14 | 28 | 14 | N |
| DV-4PVP-24B | 24" Straight Length Pipe (black) | HTI 5 | \$ 168 | 35 | 35 | 28 | 35 | N |
| DV-4PVP-18A | 18" Pipe Extension | HTI 5 | \$ 170 | 35 | 35 | 28 | 35 | N |
| DV-4PVP-36B | 36" Straight Length Pipe (black) | HTI 5 | \$ 197 | 35 | 35 | 28 | 35 | N |
| DV-4PVP-60 | 60" Straight Length Pipe | HTI 5 | \$ 216 | Y | 14 | 28 | 14 | Y |
| DV-4PVP-18AB | 18" Pipe Extension (black) | HTI 5 | \$ 242 | 35 | 35 | 28 | 35 | N |
| DV-4PVP-60B | 60" Straight Length Pipe (black) | HTI 5 | \$ 260 | 35 | 35 | 28 | 35 | N |
| DV-4PVP-60F | 60" Flex Pipe | HTI 5 | \$ 469 | 35 | 35 | 28 | 35 | N |

4" Pellet Vent Pro - Straps/Support

| | | Disc. Code | MSRP USD | 004 IA | 010 PA | 014 CA | 016 NC | EXP |
|-------------|--|---------------|-------------|-----------|-----------|-----------|-----------|-----|
| DV-4PVP-FS3 | 4" PV Ceiling Support Firestop Spacer (for 3" clearance) - Canada* | HTI 5 | \$ 99 | 35 | 35 | 28 | 35 | N |
| DV-4PVP-FS | 4" PV Ceiling Support Firestop Spacer (for 1" clearance) | HTI 5 | \$ 125 | 35 | 35 | 28 | 35 | N |
| DV-4PVP-CS | 4" PV Cathedral Ceiling Support Box | HTI 5 | \$ 221 | 35 | 35 | 28 | 35 | N |

4" Pellet Vent Pro - Termination

| | | Disc. Code | MSRP USD | 004 IA | 010 PA | 014 CA | 016 NC | EXP |
|-------------|-----------------------------|---------------|-------------|-----------|-----------|-----------|-----------|-----|
| DV-4PVP-HSC | 4" PV Square Horizontal Cap | HTI 5 | \$ 117 | 35 | 35 | 28 | 35 | N |
| DV-4PVP-VC | 4" PV Vertical Cap | HTI 5 | \$ 129 | 35 | 35 | 28 | 35 | N |

Venting

| | | Disc. Code | MSRP USD | 004 IA | 010 PA | 014 CA | 016 NC | EXP |
|--------------|--|---------------|-------------|-----------|-----------|-----------|-----------|-----|
| CCSLP | Radiance, Stardance, Oxford SLP adapter | HTI 1 | \$ 32 | Y | Y | Y | 14 | N |
| DV-46DVA-ADP | Duravent Appliance Adapter for Radiance, Stardance & Oxford | HTI 5 | \$ 106 | Y | Y | Y | 14 | Y |
| MBDVP | VCG Fireplace Unit 8" adapter to DVP (Carton of 8) | VCG 1 | \$ 159 | 8 | 21 | 14 | 14 | N |
| MBSLP | VCG Fireplace Unit adapter to SLP (Carton of 8) | VCG 1 | \$ 159 | 8 | 21 | 14 | 14 | Y |
| MPSLP | VCG Inline Pipe adapter 4x7 Twist Lock to SLP (Carton of 8) | VCG 1 | \$ 159 | 8 | 21 | 14 | 14 | Y |
| SLPMP | SLP Unit & Inline Pipe adapter To 4x7 Twist Lock (Carton of 8) | VCG 1 | \$ 166 | 8 | 21 | 14 | 14 | Y |
| DVP58P | DVP Unit & Inline Pipe adapter to 8" pipe (Carton of 8) | VCG 1 | \$ 171 | 8 | 21 | 14 | 14 | N |
| FSDHAGSLP | Freestanding Draft Hood Adapter | HTI 1 | \$ 252 | 8 | 21 | 14 | 14 | Y |
| SLP-DVFAM | SLP Flex Adapter Kit w/gear clamps (multi-pack of 4) | VCG 1 | \$ 401 | 8 | 21 | 14 | 14 | Y |
| DVP-DVFAM | DVP Flex Adapter Kit w/gear clamps (multi-pack of 4) | VCG 1 | \$ 413 | 8 | 21 | 14 | 14 | Y |

Adaptor

| | | Disc. Code | MSRP USD | 004 IA | 010 PA | 014 CA | 016 NC | EXP |
|----------|---|---------------|-------------|-----------|-----------|-----------|-----------|-----|
| ADP-CK30 | Adapter kit (required for use with CK-30) | HTI 3 | \$ 221 | Y | Y | Y | 14 | Y |
| DG3 | Thermal damper | HTI 1 | \$ 368 | Y | 14 | 14 | 14 | Y |

Flue Collars

| | | Disc. Code | MSRP USD | 004 IA | 010 PA | 014 CA | 016 NC | EXP |
|---------|--------------------------------------|---------------|-------------|-----------|-----------|-----------|-----------|-----|
| 0000555 | 8" Oval Flue Collar - Classic Black | HTI 0 | \$ 197 | 35 | 35 | 35 | 35 | Y |
| 0000561 | 8" Oval Flue Collar - Twilight | VMT 0 | \$ 296 | 35 | 35 | 35 | 35 | Y |
| 0000557 | 8" Oval Flue Collar - Majolica Brown | HTI 0 | \$ 362 | 42 | 42 | 42 | 42 | Y |
| 0000560 | 8" Oval Flue Collar - Bordeaux | VMT 0 | \$ 384 | 42 | 42 | 42 | 42 | Y |

Vermont Castings - Wood Stove Adaptors

| | | Disc. Code | MSRP USD | 004 IA | 010 PA | 014 CA | 016 NC | EXP |
|--------------|---|---------------|-------------|-----------|-----------|-----------|-----------|-----|
| 0001860 | Oval to 6" round adapter, 6" w x 11" h - Classic Black | HTI 2 | \$ 85 | Y | Y | 21 | 21 | Y |
| 0001855 | Oval to 8 round adapter, 8" w x 11" h - Classic Black | HTI 1 | \$ 85 | Y | Y | 14 | 21 | N |
| 0001841 | Oval to 8 round offset adapter, 8" x 7" | HTI 1 | \$ 124 | 35 | 35 | 35 | 35 | Y |
| 0001836 | Oval to 8" round offset adapter, 8" x 5.5" | HTI 1 | \$ 124 | 21 | Y | 28 | 21 | N |
| 0001846 | Oval to 8" round elbow, 8" x 13" | HTI 1 | \$ 131 | 35 | 35 | 35 | 35 | Y |
| DV-8DVL-ORAD | 8" x 14.5" Duravent DVL Double Wall Oval-to-Round Adapter | HTI 5 | \$ 241 | 35 | 35 | 28 | 35 | Y |
| DV-6DVL-ORAD | 6" x 14.5" Duravent DVL Double Wall Oval-to-Round Adapter | HTI 5 | \$ 241 | 35 | 35 | Y | 35 | Y |

Direct vent wall pass thru

| | | Disc. Code | MSRP USD | 004 IA | 010 PA | 014 CA | 016 NC | EXP |
|-------------|---|---------------|-------------|-----------|-----------|-----------|-----------|-----|
| 1-00-677177 | Direct vent wall pass thru for 3" or 4" chimney | HTI 1 | \$ 339 | Y | Y | Y | 14 | Y |

Top vent option

| | | Disc. Code | MSRP USD | 004 IA | 010 PA | 014 CA | 016 NC | EXP |
|-------------|--|---------------|-------------|-----------|-----------|-----------|-----------|-----|
| 1-00-777835 | Top Vent Option (Designed for use with Masonry or Class A chimneys only) | HAR 2 | \$ 509 | 35 | 35 | 35 | 35 | Y |
| 1-00-999670 | Top Vent Option (Designed for use with Masonry or Class A Chimneys only) | HAR 2 | \$ 509 | 35 | 35 | 35 | 35 | Y |
| 1-00-677120 | Top vent option (Designed for use with Masonry or Class A chimneys only) | HAR 2 | \$ 539 | 35 | 35 | 35 | 35 | Y |

14" Dura Vent DuraChimney II - Elbow

| | | Disc. Code | MSRP USD | 004 IA | 010 PA | 014 CA | 016 NC | EXP |
|-----------|--------------------------------|---------------|-------------|-----------|-----------|-----------|-----------|-----|
| 14DCA-ES | Elbow strap | HTI 1 | \$ 184 | Y | 14 | 28 | Y | N |
| 14DCA-E15 | 15 Degree elbow - must order 2 | HTI 1 | \$ 366 | 84 | 84 | 84 | 84 | N |
| 14DCA-E30 | 30 Degree elbow - must order 2 | HTI 1 | \$ 366 | Y | Y | Y | Y | Y |

14" Dura Vent DuraChimney II - Shield/Flashing/Collars

| | | Disc. Code | MSRP USD | 004 IA | 010 PA | 014 CA | 016 NC | EXP |
|-----------|---|---------------|-------------|-----------|-----------|-----------|-----------|-----|
| 14DCA-SC | Storm collar | HTI 1 | \$ 64 | Y | 14 | Y | Y | N |
| 14DCA-RRS | Roof radiation shield | HTI 1 | \$ 100 | Y | 14 | 28 | Y | N |
| 14DCA-CTC | Chase top collar | HTI 1 | \$ 287 | Y | 14 | 28 | Y | Y |
| 14DCA-CTF | Chase top flashing (Pre-bent) | HTI 1 | \$ 291 | 35 | 35 | 28 | 35 | N |
| 14DCA-IS | Attic insulation shield (consists of two parts - collar and base) | HTI 1 | \$ 714 | Y | 14 | 28 | Y | N |

14" Dura Vent DuraChimney II - Straight Section

| | | Disc. Code | MSRP USD | 004 IA | 010 PA | 014 CA | 016 NC | EXP |
|----------|---------------------|---------------|-------------|-----------|-----------|-----------|-----------|-----|
| 14DCA-12 | 12" chimney section | HTI 1 | \$ 185 | Y | Y | Y | Y | N |
| 14DCA-18 | 18" chimney section | HTI 1 | \$ 216 | Y | 14 | Y | Y | N |
| 14DCA-36 | 36" chimney section | HTI 1 | \$ 357 | Y | Y | Y | Y | N |
| 14DCA-48 | 48" chimney section | HTI 1 | \$ 383 | Y | Y | Y | Y | N |

14" Dura Vent DuraChimney II - Straps/Support

| | | Disc. Code | MSRP USD | 004 IA | 010 PA | 014 CA | 016 NC | EXP |
|----------|-----------------|---------------|-------------|-----------|-----------|-----------|-----------|-----|
| 14DCA-ST | Stabilizer | HTI 1 | \$ 89 | 49 | 49 | 49 | 49 | N |
| 14DCA-FS | Firestop spacer | HTI 1 | \$ 101 | Y | Y | Y | Y | N |
| 14DCA-WS | Wall strap | HTI 1 | \$ 193 | 35 | 35 | 35 | 35 | N |

14" Dura Vent DuraChimney II - Termination

| | | Disc. Code | MSRP USD | 004 IA | 010 PA | 014 CA | 016 NC | EXP |
|-----------|-----------------------|---------------|-------------|-----------|-----------|-----------|-----------|-----|
| 14DCA-VC1 | Round termination cap | HTI 1 | \$ 573 | Y | 14 | Y | Y | Y |

SL1100 Wood Pipe - Multi Pack - Firestop/Straps/Support Dimensions: 11" Inner / 13" Outer

| | | Disc. Code | MSRP USD | 004 IA | 010 PA | 014 CA | 016 NC | EXP |
|----------|--|---------------|-------------|-----------|-----------|-----------|-----------|-----|
| JB577 | Joint band (package of 3) | HTI 1 | \$ 63 | Y | Y | 14 | 14 | Y |
| CB576 | SL1100 and SL400 Series Chimney bracket (package of 3) | HTI 1 | \$ 77 | Y | Y | 14 | 14 | Y |
| SL11FL96 | FLASHING SL1100 SERIES4X8 | HTI 1 | \$ 352 | Y | Y | 14 | Y | N |
| FS538M | Firestop spacer for straight flue (multi-pack of 12) | HTI 1 | \$ 725 | Y | Y | 14 | Y | Y |

SL1100 Wood Pipe - Single Pack - Chimney Air Kits/Flex Duct Dimensions: 11" Inner / 13" Outer

| | | Disc. Code | MSRP USD | 004 IA | 010 PA | 014 CA | 016 NC | EXP |
|-------|---|---------------|-------------|-----------|-----------|-----------|-----------|-----|
| CAK8A | Chimney air kit (For use with BIR42 and RUTHERFORD-42, ODCASTLEWD-42) | HTI 1 | \$ 153 | Y | Y | 14 | 14 | Y |

SL1100 Wood Pipe - Single Pack - Elbow

| | | Disc. Code | MSRP USD | 004 IA | 010 PA | 014 CA | 016 NC | EXP |
|--------|-------------------------------------|---------------|-------------|-----------|-----------|-----------|-----------|-----|
| SL1130 | 30 Degree elbow (offset and return) | HTI 1 | \$ 383 | Y | Y | Y | Y | Y |

SL1100 Wood Pipe - Single Pack - Firestop/Straps/Support

| | | Disc. Code | MSRP USD | 004 IA | 010 PA | 014 CA | 016 NC | EXP |
|-------|--|---------------|-------------|-----------|-----------|-----------|-----------|-----|
| FS538 | Flat Firestop Spacer for SL1100 and SL400 Series Pipe | HTI 1 | \$ 69 | Y | Y | Y | Y | Y |
| FS540 | AC30 Degree firestop spacer for SL1100 and SL400 Series Pipe | HTI 1 | \$ 81 | Y | 14 | 14 | 14 | Y |
| SL11 | 6" (152mm) chimney stabilizer | HTI 1 | \$ 173 | Y | Y | 14 | 14 | Y |

SL1100 Wood Pipe - Single Pack - Shield/Flashing/Collars

| | | Disc. Code | MSRP USD | 004 IA | 010 PA | 014 CA | 016 NC | EXP |
|-------|---|---------------|-------------|-----------|-----------|-----------|-----------|-----|
| AS10 | Attic insulation shield, straight flue (firestop not included) for SL1100 and SL400 Series Pipe | HTI 1 | \$ 116 | Y | Y | Y | Y | Y |
| RF570 | Roof flashing, 0 - 6/12 pitch for SL1100 and SL400 Series Pipe | HTI 1 | \$ 191 | Y | Y | Y | Y | Y |
| RF571 | Roof flashing, 7/12 - 12/12 pitch for SL1100 and SL400 Series Pipe | HTI 1 | \$ 290 | Y | Y | Y | Y | Y |

SL1100 Wood Pipe - Single Pack - Straight Section Dimensions: 11" Inner / 13" Outer

| | | Disc. Code | MSRP USD | 004 IA | 010 PA | 014 CA | 016 NC | EXP |
|--------|---------------------------|---------------|-------------|-----------|-----------|-----------|-----------|-----|
| SL1106 | 6" chimney section | HTI 1 | \$ 107 | Y | Y | Y | Y | Y |
| SL1112 | 12" (305mm) pipe section | HTI 1 | \$ 116 | Y | Y | Y | Y | Y |
| SL1118 | 18" (455mm) pipe section | HTI 1 | \$ 156 | Y | Y | Y | Y | Y |
| SL1136 | 36" (915mm) pipe section | HTI 1 | \$ 226 | Y | Y | Y | Y | Y |
| SL1148 | 48" (1220mm) pipe section | HTI 1 | \$ 310 | Y | Y | Y | Y | Y |

SL1100 Wood Pipe Term Kits Acc - Sng Pk - Shield/Flashing/Collars

| | | Disc. Code | MSRP USD | 004 IA | 010 PA | 014 CA | 016 NC | EXP |
|------------|---------------------------------------|---------------|-------------|-----------|-----------|-----------|-----------|-----|
| SL1100-RDS | Roof Deck Underside Insulation Shield | HTI 1 | \$ 270 | 8 | 21 | 14 | 14 | Y |

SL1100 Wood Pipe Term Kits Acc - Sng Pk - Termination Dimensions: 11" Inner / 13" Outer

| | | Disc. Code | MSRP USD | 004 IA | 010 PA | 014 CA | 016 NC | EXP |
|----------|---|---------------|-------------|-----------|-----------|-----------|-----------|-----|
| TR11 | Round termination cap (includes 34508 storm collar) | HTI 1 | \$ 281 | Y | Y | Y | Y | Y |
| TR11T-B | Round telescoping termination cap with storm collar | HTI 1 | \$ 424 | Y | Y | Y | Y | Y |
| ST1175 | Square termination cap, painted black | HTI 1 | \$ 439 | Y | Y | 14 | Y | Y |
| TCT1175 | Terra cotta vertical termination cap | HTI 1 | \$ 640 | Y | 21 | 21 | 21 | N |
| ST1175SS | Stainless steel ST1175 termination cap | HTI 1 | \$ 833 | Y | 14 | 14 | 14 | Y |

SL300 Series Pipe - Comp - Multi-Pk - Firestop/Straps/Support Dimensions: 8" Inner / 10.5" Outer

| | | Disc. Code | MSRP USD | 004 IA | 010 PA | 014 CA | 016 NC | EXP |
|--------|---|---------------|-------------|-----------|-----------|-----------|-----------|-----|
| JB877 | Joint band (package of 3) | HTI 1 | \$ 75 | Y | Y | 14 | 14 | Y |
| CB876 | SL300 Series Chimney bracket (package of 3) | HTI 1 | \$ 97 | Y | Y | 14 | Y | Y |
| FS338M | Straight firestop spacer (multi-pack of 10) | HTI 1 | \$ 411 | Y | Y | Y | Y | Y |

SL300 Series Pipe - Comp - Multi-Pk - Shield/Flashing/Collars

| | | Disc. Code | MSRP USD | 004 IA | 010 PA | 014 CA | 016 NC | EXP |
|--------|---|---------------|-------------|-----------|-----------|-----------|-----------|-----|
| RF370M | Roof flashing, 0 - 6/12 pitch (multi-pack of 5) | HTI 1 | \$ 481 | Y | 14 | 14 | 14 | Y |

SL300 Series Pipe - Comp - SngPk - Chimney Air Kits/Flex Duct Dimensions: 8" Inner / 10.5" Outer

| | | Disc. Code | MSRP USD | 004 IA | 010 PA | 014 CA | 016 NC | EXP |
|---------|---|---------------|-------------|-----------|-----------|-----------|-----------|-----|
| CAK4A | Chimney air kit (for SL300 series chimney systems only) | HTI 1 | \$ 126 | Y | Y | 14 | 14 | Y |
| SL3FL96 | FLASHING SL300 SERIES 4X8 | HTI 1 | \$ 368 | Y | Y | 14 | Y | N |

SL300 Series Pipe - Comp - SngPk - Elbow

| | | Disc. Code | MSRP USD | 004 IA | 010 PA | 014 CA | 016 NC | EXP |
|-------|-------------------------------------|---------------|-------------|-----------|-----------|-----------|-----------|-----|
| SL315 | 15 Degree elbow (offset and return) | HTI 1 | \$ 226 | Y | Y | Y | 14 | Y |
| SL330 | 30 Degree elbow (offset and return) | HTI 1 | \$ 252 | Y | Y | Y | Y | Y |

SL300 Series Pipe - Comp - SngPk - Firestop/Straps/Support

| | | Disc. Code | MSRP USD | 004 IA | 010 PA | 014 CA | 016 NC | EXP |
|-------|-------------------------------------|---------------|-------------|-----------|-----------|-----------|-----------|-----|
| FS338 | Firestop for straight up flue | HTI 1 | \$ 55 | Y | Y | Y | Y | Y |
| FS339 | Firestop for 15 Degree angular flue | HTI 1 | \$ 75 | 8 | 21 | 14 | 14 | Y |
| FS340 | Firestop for 30 Degree angular flue | HTI 1 | \$ 112 | Y | 14 | 14 | 14 | Y |
| SL3 | 6" (200mm) flue support section | HTI 1 | \$ 118 | Y | Y | 14 | 14 | Y |
| WS30 | 30 Degree wall firestop spacer | HTI 1 | \$ 170 | 8 | 21 | 14 | 14 | Y |

SL300 Series Pipe - Comp - SngPk - Shield/Flashing/Collars

| | | Disc. Code | MSRP USD | 004 IA | 010 PA | 014 CA | 016 NC | EXP |
|-----------|--|---------------|-------------|-----------|-----------|-----------|-----------|-----|
| AS8 | Attic insulation shield, straight flue (firestop not included) | HTI 1 | \$ 115 | Y | Y | Y | Y | Y |
| RF370 | 0-6/12 pitch roof flashing | HTI 1 | \$ 171 | Y | Y | Y | Y | Y |
| SL300-RDS | Roof Deck Underside Insulation Shield | HTI 1 | \$ 270 | 8 | 21 | 14 | 14 | Y |
| RF371 | 7/12 - 12/12 pitch roof flashing | HTI 1 | \$ 270 | Y | Y | Y | Y | Y |

SL300 Series Pipe - Comp - SngPk - Straight Section

| | | Disc. Code | MSRP USD | 004 IA | 010 PA | 014 CA | 016 NC | EXP |
|--------|---|---------------|-------------|-----------|-----------|-----------|-----------|-----|
| SL306 | 6" chimney section | HTI 1 | \$ 81 | Y | Y | Y | Y | Y |
| SL312 | 12" (305mm) pipe section | HTI 1 | \$ 100 | Y | Y | Y | Y | Y |
| SL318 | 18" (455mm) pipe section | HTI 1 | \$ 111 | Y | Y | Y | Y | Y |
| SL318A | 18" chimney section, aluminized (for Canada only) | HTI 1 | \$ 112 | 8 | 21 | 14 | 14 | Y |
| SL324 | 24" chimney section | HTI 1 | \$ 135 | Y | Y | Y | Y | Y |
| SL336 | 36" (915mm) pipe section | HTI 1 | \$ 164 | Y | Y | Y | Y | Y |
| SL336A | 36" chimney section, aluminized (for Canada only) | HTI 1 | \$ 164 | Y | 21 | 14 | 14 | Y |
| SL348 | 4 ft. (1220mm) pipe section | HTI 1 | \$ 197 | Y | Y | Y | Y | Y |

SL300 Series Pipe - Term Kits & Acc - Sng Pk - Termination Dimensions: 8" Inner / 10.5" Outer

| | | Disc. Code | MSRP USD | 004 IA | 010 PA | 014 CA | 016 NC | EXP |
|---------|---|---------------|-------------|-----------|-----------|-----------|-----------|-----|
| TR344 | Round termination cap (includes 32738 storm collar) | HTI 1 | \$ 183 | Y | Y | Y | Y | Y |
| TR342-B | Round telescoping termination cap with storm collar | HTI 1 | \$ 252 | Y | Y | Y | Y | Y |
| TS345 | Trapezoid termination cap | HTI 1 | \$ 352 | Y | 21 | 14 | 14 | Y |
| TS345P | Trapezoid termination cap, painted black | HTI 1 | \$ 424 | Y | Y | 14 | Y | Y |
| ST375 | Square termination cap, painted black | HTI 1 | \$ 424 | Y | Y | Y | Y | Y |
| ST375SS | Stainless steel ST375 termination cap | HTI 1 | \$ 713 | Y | Y | 14 | 14 | Y |
| TCT375 | Terra cotta vertical termination cap, 8" | HTI 1 | \$ 713 | Y | 14 | 21 | 21 | N |

SL400 Series Pipe - Comp - SngPk - Adapter/Increaser/Tee

| | | Disc. Code | MSRP USD | 004 IA | 010 PA | 014 CA | 016 NC | EXP |
|-------|--------------------|---------------|-------------|-----------|-----------|-----------|-----------|-----|
| SLA10 | 11" to 10" adapter | HTI 1 | \$ 226 | Y | 21 | 14 | 14 | Y |

SL400 Series Pipe - Comp - SngPk - Elbow

| | | Disc. Code | MSRP USD | 004 IA | 010 PA | 014 CA | 016 NC | EXP |
|-------|-------------------------------------|---------------|-------------|-----------|-----------|-----------|-----------|-----|
| SL430 | 30 degree elbow (offset and return) | HTI 1 | \$ 411 | Y | 21 | 14 | 14 | Y |

SL400 Series Pipe - Comp - SngPk - Straight Section Dimensions: 10" Inner / 13" Outer

| | | Disc. Code | MSRP USD | 004 IA | 010 PA | 014 CA | 016 NC | EXP |
|-------|---------------------------------|---------------|-------------|-----------|-----------|-----------|-----------|-----|
| SL406 | 6" (150mm) chimney section | HTI 1 | \$ 132 | Y | 14 | 14 | 14 | Y |
| SL412 | 12" (305mm) chimney section | HTI 1 | \$ 144 | Y | 21 | 14 | 14 | Y |
| SL418 | 18" (460mm) chimney section | HTI 1 | \$ 183 | Y | 21 | 14 | 14 | Y |
| SL4 | 6" (150mm) flue support section | HTI 1 | \$ 241 | 8 | 21 | 14 | 14 | Y |
| SL436 | 36" (915mm) chimney section | HTI 1 | \$ 252 | Y | 21 | 14 | 14 | Y |
| SL448 | 48" (1220mm) chimney section | HTI 1 | \$ 324 | Y | Y | 14 | 14 | Y |

SL400 Series Pipe - Term Kits & Acc - Sng Pk - Chimney Air Kits/Flex Duct

| | | Disc. Code | MSRP USD | 004 IA | 010 PA | 014 CA | 016 NC | EXP |
|-------|---|---------------|-------------|-----------|-----------|-----------|-----------|-----|
| CAK5A | Chimney air kit for SL1100 and SL400 series pipe (required in Canada) | HTI 1 | \$ 142 | Y | Y | 14 | 14 | Y |

SL400 Series Pipe - Term Kits & Acc - Sng Pk - Termination Dimensions: 10" Inner / 13" Outer

| | | Disc. Code | MSRP USD | 004 IA | 010 PA | 014 CA | 016 NC | EXP |
|-------|---|---------------|-------------|-----------|-----------|-----------|-----------|-----|
| TR444 | Round termination cap with storm collar | HTI 1 | \$ 270 | Y | 14 | 14 | 14 | Y |

6" DuraFlex 304SS - Adapter/Increaser/Tee

| | | Disc. Code | MSRP USD | 004 IA | 010 PA | 014 CA | 016 NC | EXP |
|------------|-----------------------|---------------|-------------|-----------|-----------|-----------|-----------|-----|
| DV-6DFS-FC | 6" Duraflex Connector | HTI 5 | \$ 36 | Y | 14 | 28 | 14 | N |

6" DuraFlex 304SS - Anchor

| | | Disc. Code | MSRP USD | 004 IA | 010 PA | 014 CA | 016 NC | EXP |
|--------------|-----------------------|---------------|-------------|-----------|-----------|-----------|-----------|-----|
| DV-6DFS-TPSC | 6" Duraflex Top Plate | HTI 5 | \$ 186 | 35 | 35 | 28 | 35 | N |

6" DuraFlex 304SS - Straight Section

| | | Disc. Code | MSRP USD | 004 IA | 010 PA | 014 CA | 016 NC | EXP |
|--------------|----------------|---------------|-------------|-----------|-----------|-----------|-----------|-----|
| DV-6DF304-15 | 6 X 15' length | HTI 5 | \$ 591 | 35 | 35 | 28 | 35 | N |
| DV-6DF304-20 | 6 X 20' length | HTI 5 | \$ 772 | Y | 14 | 28 | 14 | N |
| DV-6DF304-25 | 6 X 25' length | HTI 5 | \$ 966 | Y | 14 | 28 | 14 | N |
| DV-6DF304-30 | 6 X 30' length | HTI 5 | \$ 1,169 | Y | 14 | 28 | 14 | N |

6" DuraFlex 304SS - Termination

| | | Disc. Code | MSRP USD | 004 IA | 010 PA | 014 CA | 016 NC | EXP |
|--------------|--------------------------|---------------|-------------|-----------|-----------|-----------|-----------|-----|
| DV-DFS-SA | 3-8 Spark Arrestor | HTI 5 | \$ 32 | 35 | 35 | 28 | 35 | N |
| DV-6DFS-VCRC | 6" DuraFlex Vertical Cap | HTI 5 | \$ 93 | Y | 14 | 28 | 35 | N |

Vermont Castings - Wood Stove Enamel Venting

| | | Disc. Code | MSRP USD | 004 IA | 010 PA | 014 CA | 016 NC | EXP |
|---------|--|---------------|-------------|-----------|-----------|-----------|-----------|-----|
| 0000191 | 6" and 8" Chimney Connector Heat Shield--24" | VMT 2 | \$ 89 | 35 | 35 | 35 | 35 | Y |
| 0003691 | 6" x 12" Chimney Connectors - Majolica Brown | VMT 2 | \$ 189 | Y | 21 | 21 | 21 | Y |
| 0003670 | 6" x 12" Chimney Connectors - Biscuit | VMT 2 | \$ 189 | Y | 14 | 14 | 14 | N |
| 0003694 | 6" Slip - 1 1/4" - 17" Length - Majolica Brown | VMT 2 | \$ 259 | Y | 14 | 14 | 14 | Y |
| 0003679 | 6" Slip - 1 1/4" - 17" Length - Biscuit | VMT 2 | \$ 259 | Y | 21 | 14 | 14 | N |
| 0003695 | 6" x 6 3/4" 45 Degree Elbow - Majolica Brown | VMT 2 | \$ 269 | Y | 14 | 21 | 21 | Y |
| 0003696 | 6" x 12" Chimney Connectors - Bordeaux | VMT 2 | \$ 269 | Y | 14 | 14 | 21 | N |
| 0003682 | 6" x 6 3/4" 45 Degree Elbow - Biscuit | VMT 2 | \$ 269 | Y | 14 | 21 | 21 | N |
| 0003690 | Oval to 6" round adapter, 6" w x11" h - Majolica Brown | VCG 2 | \$ 270 | Y | 21 | 21 | 14 | Y |
| 0003673 | 6" x 24" Chimney Connectors - Biscuit | VMT 2 | \$ 299 | Y | 14 | 14 | 14 | N |
| 0003692 | 6" x 24" Chimney Connectors - Majolica Brown | VMT 2 | \$ 299 | Y | 14 | 14 | 14 | Y |
| 0003693 | 6" x 7" 90 Degree Elbow - Majolica Brown | VMT 2 | \$ 309 | Y | 21 | 21 | 14 | Y |
| 0003676 | 6" x 7" 90 Degree Elbow - Biscuit | VMT 2 | \$ 309 | Y | 14 | 14 | 14 | N |
| 0003699 | 6" Slip - 1 1/4" - 17" Length - Bordeaux | VMT 2 | \$ 309 | Y | 14 | 14 | 14 | N |
| 0003701 | Oval to 6" round adapter, 6" w x11" h - Bordeaux | VCG 2 | \$ 324 | Y | 14 | 14 | 14 | Y |
| 0003700 | 6" x 6 3/4" 45 Degree Elbow - Bordeaux | VMT 2 | \$ 339 | Y | 14 | 14 | 14 | N |
| 0003697 | 6" x 24" Chimney Connectors - Bordeaux | VMT 2 | \$ 359 | Y | 119 | 119 | 119 | N |
| 0003698 | 6" x 7" 90 Degree Elbow - Bordeaux | VMT 2 | \$ 389 | Y | 14 | 14 | 14 | N |

6" DuraBlack - Adapter/Incraser/Tee

| | | Disc. Code | MSRP USD | 004 IA | 010 PA | 014 CA | 016 NC | EXP |
|--------------|---|---------------|-------------|-----------|-----------|-----------|-----------|-----|
| DV-6DBK-AD | Stovetop Adapter -Black | HTI 5 | \$ 46 | 35 | 35 | 28 | 35 | N |
| DV-6DBK-ADOR | Oval to Round Adapter | HTI 5 | \$ 54 | 35 | 35 | 28 | 35 | N |
| DV-6DBK-ADDB | Double-Skirted Stovetop Adapter - Black | HTI 5 | \$ 67 | 35 | 35 | 28 | 35 | N |
| DV-6DBK-X7 | Incraser 6"- 7" | HTI 5 | \$ 71 | 35 | 35 | 28 | 35 | N |

6" DuraTech - Adapter/Incraser/Tee

| | | Disc. Code | MSRP USD | 004 IA | 010 PA | 014 CA | 016 NC | EXP |
|-------------|-----------------------|---------------|-------------|-----------|-----------|-----------|-----------|-----|
| DV-6DT-ST | Standard Tee w/Cap GA | HTI 5 | \$ 435 | 35 | 35 | 28 | 35 | N |
| DV-6DT-STSS | Standard Tee w/Cap SS | HTI 5 | \$ 574 | 35 | 35 | 28 | 35 | N |

6" DuraTech - Anchor

| | | Disc. Code | MSRP USD | 004 IA | 010 PA | 014 CA | 016 NC | EXP |
|----------------|--------------------------|---------------|-------------|-----------|-----------|-----------|-----------|-----|
| DV-6DT-AP | 6" DuraTech anchor plate | HTI 5 | \$ 139 | 35 | 35 | 28 | 35 | N |
| DV-6DT-AP13X21 | 13x21 trans anchor plate | HTI 5 | \$ 724 | 35 | 35 | 28 | 35 | N |
| DV-6DT-AP17X17 | 17x17 trans anchor plate | HTI 5 | \$ 728 | 35 | 35 | 28 | 35 | N |
| DV-6DT-AP17X21 | 17x21 trans anchor plate | HTI 5 | \$ 739 | 35 | 35 | 28 | 35 | N |

6" DuraTech - Elbow

| | | Disc. Code | MSRP USD | 004 IA | 010 PA | 014 CA | 016 NC | EXP |
|---------------|--|---------------|-------------|-----------|-----------|-----------|-----------|-----|
| DV-6DT-E15K | 15 Degree Elbow Kit - GA (includes 2 Elbows & 1 Elbow Strap) | HTI 5 | \$ 656 | 35 | 35 | 28 | 35 | N |
| DV-6DT-E30K | 30 Degree Elbow Kit - GA (includes 2 Elbows & 1 Elbow Strap) | HTI 5 | \$ 778 | 35 | 35 | 28 | 35 | N |
| DV-6DT-E15KSS | 15 Degree Elbow Kit - SS (includes 2 Elbows & 1 Elbow Strap) | HTI 5 | \$ 803 | 35 | 35 | 28 | 35 | N |
| DV-6DT-E30KSS | 30 Degree Elbow Kit - SS (includes 2 Elbows & 1 Elbow Strap) | HTI 5 | \$ 1,071 | 35 | 35 | 28 | 35 | N |

6" DuraTech - Firestop/Straps/Support

| | | Disc. Code | MSRP USD | 004 IA | 010 PA | 014 CA | 016 NC | EXP |
|----------------|--|---------------|-------------|-----------|-----------|-----------|-----------|-----|
| DV-6DT-FRS | Firestop Radiation Shield | HTI 5 | \$ 134 | Y | 14 | 28 | 14 | N |
| DV-6DT-WSSS | Adjustable Wall Strap - SS | HTI 5 | \$ 158 | 35 | 35 | 28 | 35 | N |
| DV-6DT-ARS | 6" & 8" Adjustable Roof Support | HTI 5 | \$ 164 | 35 | 35 | 28 | 35 | Y |
| DV-6DT-WT | Wall Thimble | HTI 5 | \$ 171 | Y | 14 | 28 | 14 | N |
| DV-6DT-IS | Attic Insulation Shield | HTI 5 | \$ 175 | Y | 14 | 28 | 14 | N |
| DV-6DT-TSB | Adjustable Tee Support Bracket - GA | HTI 5 | \$ 217 | 35 | 35 | 28 | 35 | N |
| DV-6DT-CS24R-2 | Square Ceiling Support Box - 24" (Reduced Clearance) | HTI 5 | \$ 352 | | 14 | 28 | 14 | Y |
| DV-6DT-CS24-2 | Square Ceiling Support Box - 24" | HTI 5 | \$ 374 | | 14 | 28 | 14 | Y |
| DV-6DT-TSBSS | Adjustable Tee Support Bracket - SS | HTI 5 | \$ 526 | 35 | 35 | 28 | 35 | N |

6" DuraTech - Shield/Flashing/Collars

| | | Disc. Code | MSRP USD | 004 IA | 010 PA | 014 CA | 016 NC | EXP |
|---------------|--|---------------|-------------|-----------|-----------|-----------|-----------|-----|
| DV-6DT-LB | Locking Band | HTI 5 | \$ 22 | Y | Y | 28 | 14 | N |
| DV-5DT-SC | Storm Collar 5" - 6" | HTI 5 | \$ 33 | Y | Y | Y | 14 | N |
| DV-6DT-WTSS | Wall Thimble Exterior Trim - SS | HTI 5 | \$ 100 | 35 | 35 | 28 | 35 | N |
| DV-6DT-FC | Finishing Collar | HTI 5 | \$ 104 | 35 | 35 | 28 | 35 | N |
| DV-6DT-CTF | Chase top flashing | HTI 5 | \$ 115 | 35 | 35 | 28 | 35 | N |
| DV-6DT-RSTC6 | Trim Collar for Roof Support 4/12 - 6/12 | HTI 5 | \$ 134 | 35 | 35 | 28 | 35 | N |
| DV-6DT-RSTC3 | Trim Collar for Roof Support 0/12 - 3/12 | HTI 5 | \$ 134 | 35 | 35 | 28 | 35 | N |
| DV-6DT-F6 | Adjustable Roof Flashing 0/12 - 6/12 | HTI 5 | \$ 178 | Y | 14 | Y | 14 | N |
| DV-6DT-RRS | Roof Radiation Shield | HTI 5 | \$ 188 | 35 | 35 | 28 | 35 | N |
| DV-6DT-F12 | Adjustable Roof Flashing 7/12 - 12/12 | HTI 5 | \$ 230 | Y | 14 | 28 | 14 | N |
| DV-6DT-F6L | Large Base Adjustable Roof Flashing 0/12 - 6/12 | HTI 5 | \$ 237 | 35 | 35 | 28 | 35 | N |
| DV-6DT-FF | Flat Roof Flashing | HTI 5 | \$ 239 | 35 | 35 | 28 | 35 | N |
| DV-6DT-F6DSA | DSA Adjustable Roof Flashing 0/12-6/12 | HTI 5 | \$ 247 | 35 | 35 | 28 | 35 | N |
| DV-6DT-F12L | Large Base Adjustable Roof Flashing 7/12 - 12/12 | HTI 5 | \$ 315 | 35 | 35 | 28 | 35 | N |
| DV-6DT-F18 | Adjustable Roof Flashing 13/12 - 18/12 | HTI 5 | \$ 342 | 35 | 35 | 28 | 35 | N |
| DV-6DT-F12DSA | DSA Adjustable Roof Flashing 7/12-12/12 | HTI 5 | \$ 395 | 35 | 35 | 28 | 35 | N |

6" DuraTech - Straight Section

| | | Disc. Code | MSRP USD | 004 IA | 010 PA | 014 CA | 016 NC | EXP |
|-------------|----------------------------|---------------|-------------|-----------|-----------|-----------|-----------|-----|
| DV-6DT-06 | 6" Chimney Pipe - GA | HTI 5 | \$ 114 | 35 | 35 | 28 | 35 | N |
| DV-6DT-09 | 9" Chimney Pipe - GA | HTI 5 | \$ 141 | 35 | 35 | 28 | 35 | N |
| DV-6DT-06SS | 6" Chimney Pipe - SS | HTI 5 | \$ 148 | 35 | 35 | 28 | 35 | N |
| DV-6DT-09SS | 9" Chimney Pipe - SS | HTI 5 | \$ 158 | 35 | 35 | 28 | 35 | N |
| DV-6DT-12 | 12" Chimney Pipe - GA | HTI 5 | \$ 166 | Y | 14 | 28 | 14 | N |
| DV-6DT-12SS | 12" Chimney Pipe - SS | HTI 5 | \$ 168 | Y | 14 | 28 | 14 | N |
| DV-6DT-18 | 18" Chimney Pipe - GA | HTI 5 | \$ 210 | 35 | 35 | 28 | 35 | N |
| DV-6DT-18SS | 18" Chimney Pipe - SS | HTI 5 | \$ 229 | 35 | 35 | 28 | 35 | N |
| DV-6DT-24 | 24" Chimney Pipe - GA | HTI 5 | \$ 266 | Y | 14 | 28 | 14 | N |
| DV-6DT-24SS | 24" Chimney Pipe - SS | HTI 5 | \$ 305 | Y | 14 | 28 | 14 | N |
| DV-6DT-36 | 36" Chimney Pipe - GA | HTI 5 | \$ 349 | Y | 14 | Y | 14 | N |
| DV-6DT-36SS | 36" Chimney Pipe - SS | HTI 5 | \$ 406 | Y | 14 | 28 | 14 | N |
| DV-6DT-48 | 48" Chimney Pipe - GA | HTI 5 | \$ 432 | Y | 14 | Y | 14 | N |
| DV-6DT-21TA | Adjustable Pipe 14"-21" | HTI 5 | \$ 469 | 35 | 35 | 28 | 35 | N |
| DV-6DT-48SS | 48" Chimney Pipe - SS | HTI 5 | \$ 523 | Y | Y | 28 | 14 | N |
| DV-6DT-60CF | 60" Chimney Pipe - GA (CF) | HTI 5 | \$ 541 | 35 | 35 | 28 | 35 | N |

6" DuraTech - Termination

| | | Disc. Code | MSRP USD | 004 IA | 010 PA | 014 CA | 016 NC | EXP |
|-----------|----------------|---------------|-------------|-----------|-----------|-----------|-----------|-----|
| DV-5DT-SA | Spark Arrestor | HTI 5 | \$ 39 | Y | 14 | 28 | 14 | N |
| DV-6DT-VC | Chimney Cap | HTI 5 | \$ 195 | Y | Y | Y | Y | N |
| DV-6DT-SP | Snow Splitter | HTI 5 | \$ 260 | 35 | 35 | 28 | 35 | N |

6" DVL - Adapter/Increaser/Tee

| | | Disc. Code | MSRP USD | 004 IA | 010 PA | 014 CA | 016 NC | EXP |
|--------------|---------------------------------------|---------------|-------------|-----------|-----------|-----------|-----------|-----|
| DV-6DVL-ADC | DVL/DuraBlack Adapter w/Trim | HTI 5 | \$ 66 | Y | 14 | Y | 14 | Y |
| DV-6DVL-AD | Adapter Section No Damper | HTI 5 | \$ 102 | Y | Y | Y | 14 | N |
| DV-6DVL-ADWD | Adapter Section with Damper | HTI 5 | \$ 139 | 35 | 35 | 28 | 35 | N |
| DV-6DVL-T | Double-Wall Black Tee w/Clean-Out Cap | HTI 5 | \$ 194 | 35 | 35 | 28 | 35 | N |

6" DVL - Elbow

| | | Disc. Code | MSRP USD | 004 IA | 010 PA | 014 CA | 016 NC | EXP |
|-------------|-----------------------------------|---------------|-------------|-----------|-----------|-----------|-----------|-----|
| DV-6DVL-E45 | 45 Degree Double-Wall Black Elbow | HTI 5 | \$ 150 | Y | 14 | Y | 14 | N |
| DV-6DVL-E90 | 90 Degree Double-Wall Black Elbow | HTI 5 | \$ 224 | Y | 14 | 28 | 14 | N |

6" DVL - Straight Section

| | | Disc. Code | MSRP USD | 004 IA | 010 PA | 014 CA | 016 NC | EXP |
|---------------|---------------------------------------|---------------|-------------|-----------|-----------|-----------|-----------|-----|
| DV-6DVL-06 | 6" Double-Wall Black Pipe | HTI 5 | \$ 108 | Y | 14 | 28 | 14 | N |
| DV-6DVL-12 | 12" Double-Wall Black Pipe | HTI 5 | \$ 115 | Y | 14 | 28 | 14 | N |
| DV-6DVL-6ADJ | 6" Double-Wall Adjustable Black Pipe | HTI 5 | \$ 117 | Y | 14 | 28 | 14 | N |
| DV-6DVL-18 | 18" Double-Wall Black Pipe | HTI 5 | \$ 137 | Y | 14 | 28 | 14 | N |
| DV-6DVL-12ADJ | 12" Double-Wall Adjustable Black Pipe | HTI 5 | \$ 143 | Y | 14 | 28 | 14 | N |
| DV-6DVL-24 | 24" Double-Wall Black Pipe | HTI 5 | \$ 189 | Y | 14 | Y | 14 | N |
| DV-6DVL-48 | 48" Double-Wall Black Pipe | HTI 5 | \$ 291 | Y | 14 | Y | 14 | N |
| DV-6DVL-46TA | Telescoping Length 29" - 46" | HTI 5 | \$ 344 | Y | 14 | Y | 14 | N |
| DV-6DVL-68TA | Telescoping Length 40" - 68" | HTI 5 | \$ 457 | Y | 14 | Y | 14 | N |

14" Dura Vent DuraChimney II - Anchor

| | | Disc. Code | MSRP USD | 004 IA | 010 PA | 014 CA | 016 NC | EXP |
|-----------|-----------------------|---------------|-------------|-----------|-----------|-----------|-----------|-----|
| 14DCA-AP | Anchor plate | HTI 1 | \$ 388 | 84 | 84 | 84 | 84 | N |
| 14DCA-APD | Anchor plate w/damper | HTI 1 | \$ 907 | 49 | 49 | 49 | 49 | N |

Venting - Discontinued

| | | Disc. Code | MSRP USD | 004 IA | 010 PA | 014 CA | 016 NC | EXP |
|--------------|---------------------------|---------------|-------------|-----------|-----------|-----------|-----------|-----|
| DV-4PVP-CO1 | 4* CLEAN OUT TEE W/ CAP | HTI 5 | \$ 82 | 35 | 35 | 28 | 35 | Y |
| DV-4PVP-COB1 | 4*CLEAN OUT TEE W/CAP BLK | HTI 5 | \$ 101 | 35 | 35 | 28 | 35 | Y |
| DV-4PVP-HC2 | HORIZONTAL CAP | HTI 5 | \$ 104 | 35 | 35 | 28 | 35 | Y |
| DV-4PVP-T31 | INC. TEE W/ CLEAN OUT CAP | HTI 5 | \$ 222 | 35 | 35 | 28 | 35 | Y |
| DV-4PVP-T1 | SLG TEE W/ CLEAN OUT CAP | HTI 5 | \$ 228 | 35 | 35 | 28 | 35 | Y |
| DV-4PVP-T3B1 | BLK INC TEE W/ CLEAN OUT | HTI 5 | \$ 249 | 35 | 35 | 28 | 35 | Y |
| DV-4PVP-TB1 | BLK SIN TEE W/ CLEAN OUT | HTI 5 | \$ 252 | 35 | 35 | 28 | 35 | Y |

Venting - Discontinued

| | | Disc. Code | MSRP USD | 004 IA | 010 PA | 014 CA | 016 NC | EXP |
|------------|---------------------------|---------------|-------------|-----------|-----------|-----------|-----------|-----|
| DV-6DT-XRS | 6DT AD EXTENDED ROOF BRKT | HTI 5 | \$ 236 | Y | 14 | Y | Y | Y |

Hearth & Home Technologies

Termination Kits

Stocked Item/Lead Time

004=Mt. Pleasant RDC
 010=Kutztown RDC
 014=Sacramento RDC
 016=Charlotte RDC

EXP=Factory Expedite Program

Page printed 3/31/2025, 8:22:26 AM CDT

* Please Contact Who You Purchase This Through for MSRP Pricing

Prices in USD

Non-stock and custom product cannot be cancelled.

Customer is responsible for freight for orders made outside of assigned RDC facility.

Legacy Components-MultiPk - Elbow

| | | Disc. Code | MSRP USD | 004 IA | 010 PA | 014 CA | 016 NC | EXP |
|--------|--|------------|----------|--------|--------|--------|--------|-----|
| DVP90M | 90 degree elbow (multi-pack of 4)(for use with legacy Majestic unit made prior to HHT) | HTI 1 | \$ 552 | Y | 14 | Y | 14 | Y |

Legacy Components-MultiPk - Straight Section

| | | Disc. Code | MSRP USD | 004 IA | 010 PA | 014 CA | 016 NC | EXP |
|-------------|--|------------|----------|--------|--------|--------|--------|-----|
| SLP-20TPM | 20" Termination pipe (multi-pack of 6) | VCG 1 | \$ 407 | 8 | 21 | 14 | 14 | Y |
| DVP-RVT12AM | 9"-12" adj. termination pipe (multi-pack of 6) | VCG 1 | \$ 509 | 8 | 21 | 14 | 14 | Y |
| SLP-RVT12AM | 9" - 12" adj. termination pipe (multi-pack of 6) | VCG 1 | \$ 509 | 8 | 21 | 14 | 14 | Y |

Legacy Termination Kits - Multi Pk - Termination

| | | Disc. Code | MSRP USD | 004 IA | 010 PA | 014 CA | 016 NC | EXP |
|----------|---|------------|----------|--------|--------|--------|--------|-----|
| SLP-RVTM | Rear Vent Termination includes adj Termination Cap, 1" firestop (multi-pack of 4) | VCG 1 | \$ 1,005 | 8 | Y | 14 | 14 | Y |
| DVP-RVTM | Rear Vent Termination includes adj Termination Cap, 1" firestop (multi-pack of 4) | VCG 1 | \$ 1,005 | 8 | 21 | 14 | 14 | Y |

Legacy Termination Kits - Single Pk - Termination

| | | Disc. Code | MSRP USD | 004 IA | 010 PA | 014 CA | 016 NC | EXP |
|-----------|---|---------------|-------------|-----------|-----------|-----------|-----------|-----|
| AK4 | Outside Combustion Air Kit | VCG 1 | \$ 96 | Y | 14 | 14 | Y | N |
| DVP-RVTK | Rear Vent Termination Kit includes adj Termination Cap, 1" firestop, 9" - 12" adj. termination pipe | VCG 1 | \$ 324 | Y | Y | 14 | 14 | Y |
| SLP-RVTK | Rear Vent Termination Kit includes adj Termination Cap, 1" firestop, 9" - 12" adj. termination pipe | HTI 1 | \$ 324 | Y | Y | 14 | Y | Y |
| SLP-HVTK | Horizontal Vent Termination Kit includes adj Termination Cap, 1" firestop, 3" firestop, 90 degree elbow, 9" - 12" adj. termination pipe | VCG 1 | \$ 454 | Y | 14 | 14 | Y | Y |
| DVP-HVTK | Horizontal Vent Termination Kit includes adj Termination Cap, 1" firestop, 3" firestop, 90 degree elbow, 9" - 12" adj. termination pipe | VCG 1 | \$ 454 | 8 | 14 | 14 | 14 | Y |
| DVP-TRFK | Thru roof flex termination kit includes DVP-TVHW, 24" DVP pipe/roof support and flex adapters | VCG 1 | \$ 509 | 8 | 21 | 14 | 14 | Y |
| SLP-TRFK | Through roof flex termination kit includes SLP-TVHW, 24" SLP pipe, roof support and flex adapters | MAJ 1 | \$ 511 | 8 | 21 | 14 | 14 | Y |
| DVP-HSFTK | Horizontal Vent Termination Kit includes adj Termination Cap, 1" firestop, 30" Flex and adapters | VCG 1 | \$ 562 | 8 | 21 | 14 | 14 | Y |
| SLP-HSFTK | Horizontal Vent Termination Kit includes adj Termination Cap, 1" firestop, 42" Flex and adapters | VCG 1 | \$ 562 | 8 | 21 | 14 | 14 | Y |

Hearth & Home Technologies

Fireplace - Gas - Single-Sided

Stocked Item/Lead Time

004=Mt. Pleasant RDC
010=Kutztown RDC
014=Sacramento RDC
016=Charlotte RDC

EXP=Factory Expedite Program

Page printed 3/31/2025, 8:22:26 AM CDT
Current pricing updated 03/30/2025

* Please Contact Who You Purchase This Through for MSRP Pricing

Prices in USD
Non-stock and custom product cannot be cancelled.

Customer is responsible for freight for orders made outside of assigned RDC facility.

DV Linear 36

Includes:

- 16,500 Btu/Hour Input (NG/LP)
- IntelliFire ignition system
- Black firescreen
- Onyx media
- Tempered glass
- Junction box
- Battery backup
- Gas flex connector
- 4" x 6-5/8" top vent collar



No additional items required to complete.

| | | Disc. Code | MSRP USD | 004 IA | 010 PA | 014 CA | 016 NC | EXP |
|------------|---|------------|----------|--------|--------|--------|--------|-----|
| DVLINEAR36 | DV Linear 36" direct vent fireplace with IntelliFire (NG) | HTI 1 | \$ 2,349 | Y | Y | Y | 14 | N |

Conversion Kit

Conversion Kit

| | | | | | | | | |
|-------------|-------------------|-------|-------|----|----|----|----|---|
| LPK-DVLIN36 | LP conversion kit | HTI 1 | \$ 99 | 14 | 14 | 14 | 14 | Y |
|-------------|-------------------|-------|-------|----|----|----|----|---|

Fronts - Non-Operable

Clean Face Trim

| | | | | | | | | |
|------------|-------------------------|-------|--------|---|---|---|----|---|
| CFTF-36-BK | Clean Face Trim - Black | HTI 1 | \$ 459 | Y | Y | Y | 14 | Y |
|------------|-------------------------|-------|--------|---|---|---|----|---|



Clean Face Trim

Heat Management

Heat Management

| | | | | | | | | |
|--------------|--|-------|--------|---|---|---|----|---|
| PH-SIDETRIM | Passive Heat trim kit for side discharge (includes 2 side registers)(Starting collars sold separately) | HTI 1 | \$ 110 | Y | Y | Y | Y | Y |
| PH-LINEAR | Starting Collars for Non-Ducted Passive Heat (Required when using passive heat - For use with Front, Side, Top Discharges) | HTI 1 | \$ 199 | Y | Y | Y | Y | Y |
| PH-FRTRIM-36 | Passive Heat Vent Trim Kit For Front Discharge (36")(Starting collars sold separately) | HTI 1 | \$ 209 | Y | Y | Y | 21 | Y |

Control, remotes, wall switches

Remote/Wall Switch/Wall Thermostat

| | | | | | | | | | |
|-------------|---|-------|----|-----|---|---|---|---|---|
| RCT-MLT-HHT | IPI Remote Control (on/off, fan speed, flame control, temperature readout, thermostat mode, timer mode) | HTI 1 | \$ | 399 | Y | Y | Y | Y | Y |
|-------------|---|-------|----|-----|---|---|---|---|---|

Smart Stat Remote Control

| | | | | | | | | | |
|----------------|--|-------|----|-----|---|---|---|---|---|
| SMART-STAT-HHT | Remote Control - IPI or SP (on/off, temp readout, thermostat mode, timer mode) | HTI 1 | \$ | 289 | Y | Y | Y | Y | Y |
|----------------|--|-------|----|-----|---|---|---|---|---|

Venting Notes

Requires 6-5/8" SLP pipe. See venting section.

Approved for use with PVLP-SLP, PVI-SLP-B and PVV-SLP with PV-IPI-CK kit, power vent wire harness and RC100, 200 or 300 control (order separately). See venting section of manual.

DV3732

Includes:

- 13,500-19,000 Btu/Hour Input (NG)
- 14,500-18,000 Btu/Hour Input (LP)
- 5" x 8" rear vent collar
- 4" x 6-5/8" top vent collar
- 5 ceramic logs
- Full firescreen
- Black hood
- Gas flex connector
- Glowing embers
- Battery backup
- Junction box
- 12' control wire
- Tempered glass
- IntelliFire ignition



No additional items required to complete.

| | | Disc. Code | MSRP USD | 004 IA | 010 PA | 014 CA | 016 NC | EXP |
|-----------|---|------------|----------|--------|--------|--------|--------|-----|
| DV3732-B | DV3732 Top/rear direct vent fireplace with IntelliFire (NG) | HHR 1 | \$ 2,029 | Y | Y | Y | Y | N |
| DV3732L-B | DV3732 Top/rear direct vent fireplace with IntelliFire (LP) | HHR 1 | \$ 2,099 | Y | Y | Y | Y | N |

Fans

Fan

| | | | | | | | | |
|----------|--|-------|--------|---|---|---|---|---|
| GFK-160C | Fan kit 160 CFM (fan only) | HTI 1 | \$ 259 | Y | Y | Y | Y | Y |
| GFK-160A | Fan kit 160 CFM (includes rheostat and temperature sensor) | HTI 1 | \$ 319 | Y | Y | Y | Y | Y |

Trim Kits

Trim Kit 550

| | | | | | | | | |
|----------------|---|-------|--------|---|----|---|----|---|
| 550-TRIM3-BK-B | Trim Kit, 3 Sided - Black (not for use with Clean Face Kit) | HTI 1 | \$ 309 | Y | Y | Y | 14 | Y |
| 550-TRIM4-BK-B | Trim Kit, 4 Sided - Black (not for use with Clean Face Kit) | HTI 1 | \$ 369 | Y | 14 | Y | 14 | Y |

Control, remotes, wall switches

Remote/Wall Switch/Wall Thermostat

| | | | | | | | | |
|-------------|---|-------|--------|---|---|---|---|---|
| RCT-MLT-HHT | IPI Remote Control (on/off, fan speed, flame control, temperature readout, thermostat mode, timer mode) | HTI 1 | \$ 399 | Y | Y | Y | Y | Y |
|-------------|---|-------|--------|---|---|---|---|---|

Smart Stat Remote Control

| | | | | | | | | |
|----------------|--|-------|--------|---|---|---|---|---|
| SMART-STAT-HHT | Remote Control - IPI or SP (on/off, temp readout, thermostat mode, timer mode) | HTI 1 | \$ 289 | Y | Y | Y | Y | Y |
|----------------|--|-------|--------|---|---|---|---|---|

Venting Notes

Requires SLP series or SLP-Flex series pipe when venting off top of unit. See Venting section

Requires DVP series pipe when venting off rear of unit. See Venting section.

Approved for use with PVLP-SLP, PVI-SLP-B and PVV-SLP with PV-IPI-CK kit, power vent wire harness and RC100, 200 or 300 control (order separately). See venting section of manual.

DV4236

Includes:

- 15,000 - 22,000 Btu/Hour Input (NG)
- 16,500 - 20,500 Btu/Hour Input (LP)
- 5" x 8" rear vent collar
- 4" x 6-5/8" top vent collar
- 6 ceramic logs
- Full firescreen
- Black hood
- Gas flex connector
- Glowing embers
- Battery backup
- Junction box
- 12' control wire
- Tempered glass
- IntelliFire ignition



No additional items required to complete.

| | | Disc. Code | MSRP USD | 004 IA | 010 PA | 014 CA | 016 NC | EXP |
|----------|---|------------|----------|--------|--------|--------|--------|-----|
| DV4236-B | DV4236 Top/rear direct vent fireplace with IntelliFire (NG) | HHR 1 | \$ 2,269 | Y | Y | Y | Y | N |

Conversion Kit

Conversion Kit

| | | | | | | | | |
|----------|---------------------------|-------|-------|---|---|---|---|---|
| LPK-4236 | LP conversion kit- DV4236 | HTI 1 | \$ 99 | Y | Y | Y | Y | Y |
|----------|---------------------------|-------|-------|---|---|---|---|---|

Fans

Fan

| | | | | | | | | |
|----------|--|-------|--------|---|---|---|---|---|
| GFK-160C | Fan kit 160 CFM (fan only) | HTI 1 | \$ 259 | Y | Y | Y | Y | Y |
| GFK-160A | Fan kit 160 CFM (includes rheostat and temperature sensor) | HTI 1 | \$ 319 | Y | Y | Y | Y | Y |

Trim Kits

Trim Kits

| | | | | | | | | |
|----------------|---|-------|--------|---|----|----|----|---|
| 750-TRIM3-BK-B | Trim Kit, 3 Sided - Black (not for use with Clean Face Kit) | HTI 1 | \$ 329 | Y | 14 | 14 | 14 | Y |
| 750-TRIM4-BK-B | Trim Kit, 4 Sided - Black (not for use with Clean Face Kit) | HTI 1 | \$ 379 | Y | 14 | Y | 14 | Y |

Control, remotes, wall switches

Remote/Wall Switch/Wall Thermostat

| | | | | | | | | |
|-------------|---|-------|--------|---|---|---|---|---|
| RCT-MLT-HHT | IPI Remote Control (on/off, fan speed, flame control, temperature readout, thermostat mode, timer mode) | HTI 1 | \$ 399 | Y | Y | Y | Y | Y |
|-------------|---|-------|--------|---|---|---|---|---|

Smart Stat Remote Control

| | | | | | | | | |
|----------------|--|-------|--------|---|---|---|---|---|
| SMART-STAT-HHT | Remote Control - IPI or SP (on/off, temp readout, thermostat mode, timer mode) | HTI 1 | \$ 289 | Y | Y | Y | Y | Y |
|----------------|--|-------|--------|---|---|---|---|---|

Venting Notes

Requires SLP series or SLP-Flex series pipe when venting off top of unit. See Venting section

Requires DVP series pipe when venting off rear of unit. See Venting section.

Approved for use with PVLP-SLP, PVI-SLP-B and PVV-SLP with PV-IPI-CK kit, power vent wire harness and RC100, 200 or 300 control (order separately). See venting section of manual.

Reveal 36

Includes:

- 40,000 Btu/Hour Input (NG)
- 38,000 BTU/Hour Input (LP)
- Traditional Refractory
- Glowing embers, lava rock, vermiculite
- 6 ceramic fiber logs
- Black hood
- Outside air kit
- Junction box
- Gas flex connector
- Manual gas shut-off valve
- 18' control wire
- 6" B-vent collar
- Mesh
- Battery backup



Special Considerations:

- Remotes w/ thermostat function only approved for use in a bedroom or bed sitting room in Canada

No additional items required to complete.

| | | Disc. Code | MSRP USD | 004 IA | 010 PA | 014 CA | 016 NC | EXP |
|-----------|---|------------|----------|--------|--------|--------|--------|-----|
| RBV4236IT | Reveal 36 36" Open Hearth B-Vent Gas Fireplace radiant unit with IntelliFire (NG) with traditional brick refractory | HTI 1 | \$ 2,289 | Y | 14 | 14 | Y | N |

Conversion Kit

Conversion Kit

| | | | | | | | | |
|----------|---------------------------------------|-------|-------|---|----|----|---|---|
| DCKP-RBV | LP gas conversion kit for IntelliFire | HTI 1 | \$ 99 | Y | 14 | 14 | Y | Y |
|----------|---------------------------------------|-------|-------|---|----|----|---|---|

Glass Doors - Operable

Glass Bi-Fold Door

| | | | | | | | | |
|---------|--|-------|--------|---|----|----|----|---|
| DM1036 | Original bi-fold glass doors with black trim | HTI 1 | \$ 539 | Y | Y | Y | Y | Y |
| DM1036S | Original bi-fold glass doors with stainless steel trim | HTI 1 | \$ 589 | 8 | 14 | 14 | 14 | Y |



Glass Bi-Fold Door

Control, remotes, wall switches

Smart Stat Remote Control

| | | | | | | | | |
|----------------|--|-------|--------|---|---|---|---|---|
| SMART-STAT-HHT | Remote Control - IPI or SP (on/off, temp readout, thermostat mode, timer mode) | HTI 1 | \$ 289 | Y | Y | Y | Y | Y |
|----------------|--|-------|--------|---|---|---|---|---|

Wall Switch

| | | | | | | | | |
|----------|---|-------|-------|---|---|---|---|---|
| WSK-21-W | Wall switch kit- White (includes 20 ft of wire) | HTI 1 | \$ 40 | Y | Y | Y | Y | Y |
|----------|---|-------|-------|---|---|---|---|---|

Venting

Insulated Flex Duct - Chimney Air Kits/Flex Duct

| | | | | | | | | |
|-----|---|-------|-------|---|---|----|---|---|
| ID4 | 4" (100mm) insulated flex duct for outside air - includes two 42" (1065mm) sections | HTI 1 | \$ 87 | Y | Y | 14 | Y | Y |
|-----|---|-------|-------|---|---|----|---|---|

Uninsulated Flex Duct - Chimney Air Kits/Flex Duct

| | | | | | | | | | |
|-----|---|-------|----|----|---|---|---|---|---|
| UD4 | 4" (100mm) uninsulated flex duct for outside air - includes two 42" (1065mm) sections | HTI 1 | \$ | 56 | Y | Y | Y | Y | Y |
|-----|---|-------|----|----|---|---|---|---|---|

Adaptor

| | | | | | | | | | |
|-----|----------------|-------|----|-----|---|----|----|----|---|
| DG3 | Thermal damper | HTI 1 | \$ | 368 | Y | 14 | 14 | 14 | Y |
|-----|----------------|-------|----|-----|---|----|----|----|---|

Venting Notes

Requires 6" B-vent pipe. See venting section.

Reveal 42

Includes:

- 43,000 Btu/Hour Input (NG)
- 41,000 Btu/Hour Input (LP)
- Glowing embers, lava rock, vermiculite
- 6 ceramic fiber logs
- Black hood
- Mesh
- Junction box
- Gas flex connector
- Manual gas shut-off valve
- 18' control wire
- 6" B-vent collar
- Outside air kit
- Battery backup
- Traditional Refractory



Special Considerations:

- Remotes w/ thermostat function only approved for use in a bedroom or bed sitting room in Canada

No additional items required to complete.

| | | Disc. Code | MSRP USD | 004 IA | 010 PA | 014 CA | 016 NC | EXP |
|-----------|---|------------|----------|--------|--------|--------|--------|-----|
| RBV4842IT | Reveal 42 42" Open Hearth B-Vent Gas Fireplace radiant unit with IntelliFire (NG) with traditional brick refractory | HTI 1 | \$ 2,669 | Y | 14 | 14 | Y | N |

Conversion Kit

Conversion Kit

| | | | | | | | | |
|----------|---------------------------------------|-------|-------|---|----|----|---|---|
| DCKP-RBV | LP gas conversion kit for IntelliFire | HTI 1 | \$ 99 | Y | 14 | 14 | Y | Y |
|----------|---------------------------------------|-------|-------|---|----|----|---|---|

Glass Doors - Operable

Glass Bi-Fold Door

| | | | | | | | | |
|---------|--|-------|--------|----|----|----|----|---|
| DM1042 | Original bi-fold glass doors with black trim | HTI 1 | \$ 669 | Y | Y | Y | Y | Y |
| DM1042S | Original bi-fold glass doors with stainless steel trim | HTI 1 | \$ 719 | 14 | 14 | 14 | 14 | Y |



Glass Bi-Fold Door

Control, remotes, wall switches

Smart Stat Remote Control

| | | | | | | | | |
|----------------|--|-------|--------|---|---|---|---|---|
| SMART-STAT-HHT | Remote Control - IPI or SP (on/off, temp readout, thermostat mode, timer mode) | HTI 1 | \$ 289 | Y | Y | Y | Y | Y |
|----------------|--|-------|--------|---|---|---|---|---|

Wall Switch

| | | | | | | | | |
|----------|---|-------|-------|---|---|---|---|---|
| WSK-21-W | Wall switch kit- White (includes 20 ft of wire) | HTI 1 | \$ 40 | Y | Y | Y | Y | Y |
|----------|---|-------|-------|---|---|---|---|---|

Venting

Insulated Flex Duct - Chimney Air Kits/Flex Duct

| | | | | | | | | |
|-----|---|-------|-------|---|---|----|---|---|
| ID4 | 4" (100mm) insulated flex duct for outside air - includes two 42" (1065mm) sections | HTI 1 | \$ 87 | Y | Y | 14 | Y | Y |
|-----|---|-------|-------|---|---|----|---|---|

Uninsulated Flex Duct - Chimney Air Kits/Flex Duct

| | | | | | | | | | |
|-----|---|-------|----|----|---|---|---|---|---|
| UD4 | 4" (100mm) uninsulated flex duct for outside air - includes two 42" (1065mm) sections | HTI 1 | \$ | 56 | Y | Y | Y | Y | Y |
|-----|---|-------|----|----|---|---|---|---|---|

Adaptor

| | | | | | | | | | |
|-----|----------------|-------|----|-----|---|----|----|----|---|
| DG3 | Thermal damper | HTI 1 | \$ | 368 | Y | 14 | 14 | 14 | Y |
|-----|----------------|-------|----|-----|---|----|----|----|---|

Venting Notes

Requires 6" B-vent pipe. See venting section

Hearth & Home Technologies

Fireplace - Gas - Multi-Sided

Stocked Item/Lead Time

004=Mt. Pleasant RDC
010=Kutztown RDC
014=Sacramento RDC
016=Charlotte RDC

EXP=Factory Expedite Program

Page printed 3/31/2025, 8:22:26 AM CDT
Current pricing updated 03/30/2025

Prices in USD

Non-stock and custom product cannot be cancelled.

* Please Contact Who You Purchase This Through for MSRP Pricing

Customer is responsible for freight for orders made outside of assigned RDC facility.

Corner Gas Fireplace L/R-COR

Includes:

- 38,000 - 21,000 BTU/Hour input (NG)
- 35,500 - 20,000 BTU/Hour input (LP)
- Intellifire touch ignition system
- 7 ceramic fiber logs
- Glowing embers, lava rock
- Tempered glass
- Fiber brick refractory
- 12' control wire
- Junction box
- Battery backup
- Gas flex connector
- Manual gas shut off valve



Required to Complete - Sold Separately: • Front (x1) • End panel (x1)

| | | Disc. Code | MSRP USD | 004 IA | 010 PA | 014 CA | 016 NC | EXP |
|-------------|---|------------|----------|--------|--------|--------|--------|-----|
| LCOR-DV36IN | 36" Left Corner Direct Vent Multi Side Top/Rear Gas Fireplace with Intellifire Touch Ignition (NG) | HTI 1 | \$ 4,309 | 14 | 14 | 14 | 14 | N |
| RCOR-DV36IN | 36" Right Corner Direct Vent Multi Side Top/Rear Gas Fireplace with Intellifire Touch Ignition (NG) | HTI 1 | \$ 4,309 | 14 | 14 | 14 | 14 | N |

Fronts - Non-Operable (Required to Complete)

Corner End Panel

| | | | | | | | | |
|------------|---|-------|--------|---|---|---|----|---|
| COREP-36BK | Corner end panel Firescreen front - Black | HTI 1 | \$ 379 | Y | Y | Y | 14 | Y |
|------------|---|-------|--------|---|---|---|----|---|

Corner Firescreen

| | | | | | | | | |
|----------|---------------------------------|-------|--------|---|---|---|----|---|
| COR-36BK | Corner Firescreen front - Black | HTI 1 | \$ 299 | Y | Y | Y | 14 | N |
|----------|---------------------------------|-------|--------|---|---|---|----|---|



Corner End Panel



Corner Firescreen

Conversion Kit

Conversion Kit

| | | | | | | | | |
|--------------|--|-------|-------|---|---|---|---|---|
| LPK-MS36-IFT | NG to LP conversion kit 36" multi side units | HTI 1 | \$ 99 | Y | Y | Y | Y | Y |
|--------------|--|-------|-------|---|---|---|---|---|

| Fans | | | | | | |
|---|---|-------|----|-----|---|----|
| Fan | | | | | | |
| GFK-160C | Fan kit 160 CFM (fan only) | HTI 1 | \$ | 259 | Y | Y |
| GFK-160A | Fan kit 160 CFM (includes rheostat and temperature sensor) | HTI 1 | \$ | 319 | Y | Y |
| Control, remotes, wall switches | | | | | | |
| IntelliFire app | | | | | | |
| IFT-WFM | IntelliFire Wi-Fi Module that works with the IntelliFire iOS and Android app. Use to control all the features of your fireplace via a smart device. An RC400, RC450 or RC150 is required for thermostat control | HTI 1 | \$ | 229 | Y | Y |
| IntelliFire Touch Controls - Aux Module | | | | | | |
| IFT-ACM | IntelliFire Touch AUX Module. Must order if adding Fan, Lights or Power Vent and want to use the IFT-WFM. Do not need to order if using IFT-RC400 (includes IFT-ACM). | HTI 1 | \$ | 98 | Y | Y |
| Remote/Wall Switch/Wall Thermostat | | | | | | |
| IFT-RC150 | IntelliFire Touch white wireless wall switch (on/off, cold climate, battery strength | HTI 1 | \$ | 121 | Y | 14 |
| Touch Screen Remote | | | | | | |
| IFT-RC400 | IntelliFire Touch black remote control, docking station and auxiliary control module (on/off, flame height, thermostat mode, fan control, child lock, cold climate, timer mode, hot indicator, lights, on-screen maintenance and troubleshooting notifications) | HTI 1 | \$ | 389 | Y | Y |
| Wall Switch | | | | | | |
| IFT-RC150-HTL | IntelliFire Touch white wireless wall switch (on/off, cold climate, battery strength indicator) | HTL 1 | \$ | 121 | Y | 14 |
| IFT-RC150-HNG | IntelliFire Touch white wireless wall switch (on/off, cold climate, battery strength indicator) | HNG 1 | \$ | 121 | Y | Y |



IntelliFire app

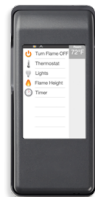

Touch Screen Remote



Wall Switch

| Venting Notes |
|--|
| Requires DVP venting. See venting section of install manual. |
| Approved for SLP venting. See venting section of install manual. |
| Approved for use with PVLP-SLP, PVI-SLP-B and PVV-SLP with power vent wire harness (order separately) and IFT-RC400 remote. See venting section of manual. |

Pier 36

Includes:

- 38,000 - 21,000 BTU/Hour input (NG)
- 35,500 - 20,000 BTU/Hour input (LP)
- 6 ceramic fiber logs
- Glowing embers, lava rock
- Tempered glass
- Black steel refractory
- 12' control wire
- Junction box
- Battery backup
- IntelliFire Touch ignition system
- Gas flex connector
- Manual gas shut off valve



Special Considerations:

- Crushed glass and stone media require the purchase of the STPR-MOD-KIT

Required to Complete - Sold Separately: • Fronts (x2) • End panel (x1)

| | | Disc. Code | MSRP USD | 004 IA | 010 PA | 014 CA | 016 NC | EXP |
|-------------|---|------------|----------|--------|--------|--------|--------|-----|
| PIER-DV36IN | 36" Pier Direct Vent Multi Side Top/Rear Gas Fireplace With IntelliFire Touch ignition (NG) | HTI 1 | \$ 4,659 | Y | 14 | 14 | 14 | N |

Fronts - Non-Operable (Required to Complete)

Multi Side Front

| | | | | | | | | |
|------------|-------------------------------------|-------|--------|---|---|---|---|---|
| MSFR-36-BK | Multi Side Firescreen Front - Black | HTI 1 | \$ 349 | Y | Y | Y | Y | Y |
|------------|-------------------------------------|-------|--------|---|---|---|---|---|



Multi Side Front

End Panels (Required to Complete)

Multi Side Front End Panel

| | | | | | | | | |
|------------|---|-------|--------|---|----|----|----|---|
| MSEP-36-BK | Multi Side End Panel Firescreen Front - Black | HTI 1 | \$ 379 | Y | 14 | 14 | 14 | Y |
|------------|---|-------|--------|---|----|----|----|---|

Conversion Kit

Conversion Kit

| | | | | | | | | |
|--------------|---|-------|--------|----|----|----|----|---|
| LPK-MS36-IFT | NG to LP conversion kit 36" multi side units | HTI 1 | \$ 99 | Y | Y | Y | Y | Y |
| STPR-MOD-KIT | Contemporary conversion kit for See Through and Peninsula units (must order media to complete) (for use with standard black metal refractory or Black glass interior panels only) | HTI 1 | \$ 619 | 14 | 21 | 14 | 14 | Y |

| Media | | | | | | | | | | |
|---|---|-------|--------|----|----|----|----|---|--|--|
| Crushed Glass Media | | | | | | | | | | |
| MEDIA-CLEAR-MS | Glass media, Crystal (translucent white) (must order STPR-MOD-KIT to complete) | HTI 1 | \$ 209 | 14 | 21 | 14 | 14 | Y | | |
| MEDIA-FOG-MS | Iced fog media (requires black spray paint to complete) (must order STPR-MOD-KIT to complete) | HTI 1 | \$ 259 | 14 | 21 | 14 | 14 | Y | | |
| MEDIA-AMBER-MS | Glass media, (Amber) (must order STPR-MOD-KIT to complete) | HTI 1 | \$ 259 | 14 | 21 | 14 | 14 | Y | | |
| MEDIA-RED-MS | Glass media, Scarlet (red) (must order STPR-MOD-KIT to complete) | HTI 1 | \$ 259 | 14 | 21 | 14 | 14 | Y | | |
| MEDIA-COBALT-MS | Glass media, Cobalt (blue) (must order STPR-MOD-KIT to complete) | HTI 1 | \$ 259 | 14 | 21 | 14 | 14 | Y | | |
| MEDIA-EBONY-MS | Glass media, Ebony (black) (must order STPR-MOD-KIT to complete) | HTI 1 | \$ 259 | 14 | 21 | 14 | 14 | Y | | |
| Stone Media | | | | | | | | | | |
| MEDIA-STONES-30 | Large, multi-colored fiber stone media | HTI 1 | \$ 219 | 14 | 21 | 14 | 14 | Y | | |
| Liner Kit | | | | | | | | | | |
| Liner Kit | | | | | | | | | | |
| LINER-36PIER | Reflective Black glass interior panels for Peninsula | HTI 1 | \$ 589 | 14 | 21 | 14 | 14 | Y | | |
| Refractory Upgrade | | | | | | | | | | |
| Brick Refractory | | | | | | | | | | |
| WTB36-PR | Traditional brick interior liner 36" Peninsula - Weathered Traditional Brick | HTI 1 | \$ 309 | 56 | 63 | 63 | 63 | Y | | |
| Fans | | | | | | | | | | |
| Fan | | | | | | | | | | |
| GFK-160C | Fan kit 160 CFM (fan only) | HTI 1 | \$ 259 | Y | Y | Y | Y | Y | | |
| GFK-160A | Fan kit 160 CFM (includes rheostat and temperature sensor) | HTI 1 | \$ 319 | Y | Y | Y | Y | Y | | |
| Control, remotes, wall switches | | | | | | | | | | |
| Battery Back Up | | | | | | | | | | |
| BATTERY-WSK | Battery backup wall switch kit for units with IFT control systems. Includes: On/Off Wall Switch, USB-C Port, Battery Backup, Cover Plate, 12' Wire Harness | HTI 1 | \$ 189 | Y | 14 | Y | 14 | Y | | |
| IntelliFire app | | | | | | | | | | |
| IFT-WFM | IntelliFire Wi-Fi Module that works with the IntelliFire iOS and Android app. Use to control all the features of your fireplace via a smart device. An RC400, RC450 or RC150 is required for thermostat control | HTI 1 | \$ 229 | Y | Y | Y | Y | Y | | |
| IntelliFire Touch Controls - Aux Module | | | | | | | | | | |
| IFT-ACM | IntelliFire Touch AUX Module. Must order if adding Fan, Lights or Power Vent and want to use the IFT-WFM. Do not need to order if using IFT-RC400 (includes IFT-ACM). | HTI 1 | \$ 98 | Y | Y | 14 | 14 | Y | | |
| Remote/Wall Switch/Wall Thermostat | | | | | | | | | | |
| IFT-RC150 | IntelliFire Touch white wireless wall switch (on/off, cold climate, battery strength | HTI 1 | \$ 121 | Y | 14 | 14 | Y | Y | | |
| Touch Screen Remote | | | | | | | | | | |
| IFT-RC400 | IntelliFire Touch black remote control, docking station and auxiliary control module (on/off, flame height, thermostat mode, fan control, child lock, cold climate, timer mode, hot indicator, lights, on-screen maintenance and troubleshooting notifications) | HTI 1 | \$ 389 | Y | Y | Y | Y | Y | | |

| Wall Switch | | | | | | | | | |
|---------------|---|-------|----|-----|---|----|----|---|---|
| IFT-RC150-HTL | IntelliFire Touch white wireless wall switch (on/off, cold climate, battery strength indicator) | HTL 1 | \$ | 121 | Y | 14 | 14 | Y | Y |
| IFT-RC150-HNG | IntelliFire Touch white wireless wall switch (on/off, cold climate, battery strength indicator) | HNG 1 | \$ | 121 | Y | Y | Y | Y | Y |



Battery Back Up



IntelliFire app

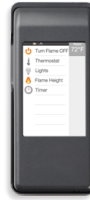

Touch Screen Remote



Wall Switch

| Venting Notes |
|--|
| Requires DVP venting. See venting section of install manual. |
| Approved for SLP venting. See venting section of install manual. |
| Approved for use with PVLP-SLP, PVI-SLP-B and PVV-SLP with power vent wire harness (order separately) and IFT-RC400 remote. See venting section of manual. |

See Through 36

Includes:

- 38,000 - 21,000 BTU/Hour input (NG)
- 35,500 - 20,000 BTU/Hour input (LP)
- 6 ceramic fiber logs
- Glowing embers, lava rock
- Tempered glass
- Black steel refractory
- 12' control wire
- Junction box
- Battery backup
- IntelliFire Touch ignition system
- Gas flex connector
- Manual gas shut off valve



Special Considerations:

- Crushed glass and stone media require the purchase of the STPR-MOD-KIT

Required to Complete - Sold Separately: • Fronts (x2)

| | | Disc. Code | MSRP USD | 004 IA | 010 PA | 014 CA | 016 NC | EXP |
|-----------|--|------------|----------|--------|--------|--------|--------|-----|
| ST-DV36IN | 36" See Through Direct Vent Multi Side Top/Rear Gas Fireplace With IntelliFire Touch Ignition (NG) | HTI 1 | \$ 4,739 | Y | Y | Y | Y | N |

Fronts - Non-Operable (Required to Complete)

Multi Side Front

| | | | | | | | | |
|------------|-------------------------------------|-------|--------|---|---|---|---|---|
| MSFR-36-BK | Multi Side Firescreen Front - Black | HTI 1 | \$ 349 | Y | Y | Y | Y | Y |
|------------|-------------------------------------|-------|--------|---|---|---|---|---|



Multi Side Front

Conversion Kit

Conversion Kit

| | | | | | | | | |
|--------------|---|-------|--------|----|----|----|----|---|
| LPK-MS36-IFT | NG to LP conversion kit 36" multi side units | HTI 1 | \$ 99 | Y | Y | Y | Y | Y |
| STPR-MOD-KIT | Contemporary conversion kit for See Through and Peninsula units (must order media to complete) (for use with standard black metal refractory or Black glass interior panels only) | HTI 1 | \$ 619 | 14 | 21 | 14 | 14 | Y |

Media

Crushed Glass Media

| | | | | | | | | |
|-----------------|---|-------|--------|----|----|----|----|---|
| MEDIA-CLEAR-MS | Glass media, Crystal (translucent white) (must order STPR-MOD-KIT to complete) | HTI 1 | \$ 209 | 14 | 21 | 14 | 14 | Y |
| MEDIA-RED-MS | Glass media, Scarlet (red) (must order STPR-MOD-KIT to complete) | HTI 1 | \$ 259 | 14 | 21 | 14 | 14 | Y |
| MEDIA-AMBER-MS | Glass media, (Amber) (must order STPR-MOD-KIT to complete) | HTI 1 | \$ 259 | 14 | 21 | 14 | 14 | Y |
| MEDIA-COBALT-MS | Glass media, Cobalt (blue) (must order STPR-MOD-KIT to complete) | HTI 1 | \$ 259 | 14 | 21 | 14 | 14 | Y |
| MEDIA-EBONY-MS | Glass media, Ebony (black) (must order STPR-MOD-KIT to complete) | HTI 1 | \$ 259 | 14 | 21 | 14 | 14 | Y |
| MEDIA-FOG-MS | Iced fog media (requires black spray paint to complete) (must order STPR-MOD-KIT to complete) | HTI 1 | \$ 259 | 14 | 21 | 14 | 14 | Y |

| | | | | | | | | | | |
|--|---|-------|--------|----|----|----|----|----|----|---|
| Stone Media | | | | | | | | | | |
| MEDIA-STONES-30 | Large, multi-colored fiber stone media | HTI 1 | \$ 219 | 14 | 21 | 14 | 14 | 14 | 14 | Y |
| Liner Kit | | | | | | | | | | |
| Liner Kit | | | | | | | | | | |
| LINER-36ST | Reflective Black glass interior panels for See-Through | HTI 1 | \$ 659 | 14 | 14 | 14 | 14 | 14 | 14 | Y |
| Refractory Upgrade | | | | | | | | | | |
| Brick Refractory | | | | | | | | | | |
| WTB36-ST | Traditional brick interior liner 36" See Through - Weathered Traditional Brick | HTI 1 | \$ 399 | Y | 14 | 14 | 14 | 14 | 14 | Y |
| Fans | | | | | | | | | | |
| Fan | | | | | | | | | | |
| GFK-160C | Fan kit 160 CFM (fan only) | HTI 1 | \$ 259 | Y | Y | Y | Y | Y | Y | Y |
| GFK-160A | Fan kit 160 CFM (includes rheostat and temperature sensor) | HTI 1 | \$ 319 | Y | Y | Y | Y | Y | Y | Y |
| Control, remotes, wall switches | | | | | | | | | | |
| Battery Back Up | | | | | | | | | | |
| BATTERY-WSK | Battery backup wall switch kit for units with IFT control systems. Includes: On/Off Wall Switch, USB-C Port, Battery Backup, Cover Plate, 12' Wire Harness | HTI 1 | \$ 189 | Y | 14 | Y | 14 | Y | 14 | Y |
| IntelliFire app | | | | | | | | | | |
| IFT-WFM | IntelliFire Wi-Fi Module that works with the IntelliFire iOS and Android app. Use to control all the features of your fireplace via a smart device. An RC400, RC450 or RC150 is required for thermostat control | HTI 1 | \$ 229 | Y | Y | Y | Y | Y | Y | Y |
| IntelliFire Touch Controls - Aux Module | | | | | | | | | | |
| IFT-ACM | IntelliFire Touch AUX Module. Must order if adding Fan, Lights or Power Vent and want to use the IFT-WFM. Do not need to order if using IFT-RC400 (includes IFT-ACM). | HTI 1 | \$ 98 | Y | Y | 14 | 14 | Y | 14 | Y |
| Remote/Wall Switch/Wall Thermostat | | | | | | | | | | |
| IFT-RC150 | IntelliFire Touch white wireless wall switch (on/off, cold climate, battery strength | HTI 1 | \$ 121 | Y | 14 | 14 | Y | 14 | Y | Y |
| Touch Screen Remote | | | | | | | | | | |
| IFT-RC400 | IntelliFire Touch black remote control, docking station and auxiliary control module (on/off, flame height, thermostat mode, fan control, child lock, cold climate, timer mode, hot indicator, lights, on-screen maintenance and troubleshooting notifications) | HTI 1 | \$ 389 | Y | Y | Y | Y | Y | Y | Y |
| Wall Switch | | | | | | | | | | |
| IFT-RC150-HTL | IntelliFire Touch white wireless wall switch (on/off, cold climate, battery strength indicator) | HTL 1 | \$ 121 | Y | 14 | 14 | Y | 14 | Y | Y |
| IFT-RC150-HNG | IntelliFire Touch white wireless wall switch (on/off, cold climate, battery strength indicator) | HNG 1 | \$ 121 | Y | Y | Y | Y | Y | Y | Y |

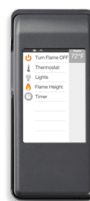

Battery Back Up

IntelliFire app

Touch Screen Remote

Wall Switch

Venting Notes

Requires DVP venting. See venting section of install manual.

Approved for SLP venting. See venting section of install manual.

Approved for use with PVLV-SLP, PVI-SLP-B and PVV-SLP with power vent wire harness (order separately) and IFT-RC400 remote. See venting section of manual.

Hearth & Home Technologies

Fireplace - Wood - Single-Sided

Stocked Item/Lead Time
 004=Mt. Pleasant RDC
 010=Kutztown RDC
 014=Sacramento RDC
 016=Charlotte RDC
 EXP=Factory Expedite Program

Page printed 3/31/2025, 8:22:26 AM CDT
 Current pricing updated 03/30/2025

Prices in USD

Non-stock and custom product cannot be cancelled.

* Please Contact Who You Purchase This Through for MSRP Pricing

Customer is responsible for freight for orders made outside of assigned RDC facility.

Pioneer II

Includes:

- 68,200 Peak Btu/Hour Output
- Automatic Combustion Control
- Front and single cast iron arched door
- Dual fans with speed control
- Welded steel firebox
- CAK4A
- Outside air hood
- Attic insulation shield
- 2.7 cu/ft firebox



Special Considerations:

- Advanced Technology Product training required before product ships
- Certified to 2020 EPA emissions standards

No additional items required to complete.

| | | Disc. Code | MSRP USD | 004 IA | 010 PA | 014 CA | 016 NC | EXP |
|----------------|--|------------|----------|--------|--------|--------|--------|-----|
| PIONEER-II-ARC | Wood fireplace, with classic black front and single arch door | HTI 3 | \$ 6,389 | Y | Y | Y | Y | N |
| PIONEER-II-REC | Wood fireplace, with classic black front and single rectangle door | HTI 3 | \$ 6,389 | Y | 14 | 14 | 14 | N |

Options & Accessories

Finishing Template

| | | | | | | | | |
|-------------|--------------------------------------|-------|--------|---|----|----|----|---|
| TMP-MED-ARC | Metal Finishing Template - Arched | HTI 3 | \$ 199 | Y | 14 | 14 | 14 | Y |
| TMP-MED-REC | Metal Finishing Template - Rectangle | HTI 3 | \$ 199 | 8 | 14 | 14 | 14 | Y |

Lintel Bar

| | | | | | | | | |
|---------------|------------|-------|--------|---|----|----|----|---|
| LINTELBAR-HHT | Lintel bar | HTI 1 | \$ 359 | 8 | 21 | 14 | 14 | Y |
|---------------|------------|-------|--------|---|----|----|----|---|

Heat Management

Heat Zone Kit

| | | | | | | | | |
|----------------|--|-------|--------|---|---|---|---|---|
| HEAT-ZONE-WD-C | Heat distribution kit (includes fan, grille cover, fireplace adaptor, and adjustment control) requires 6" vent for ducting | HTI 1 | \$ 399 | Y | Y | Y | Y | Y |
|----------------|--|-------|--------|---|---|---|---|---|

Floor Protector (HP)

Micore Hearth Extension - Hearth Extension

| | | | | | | | | |
|------|---|-------|--------|---|---|---|---|---|
| HX4M | Hearth extension for all size models (70"x 20"x 1/2") - pack of 5 | HTI 1 | \$ 429 | Y | Y | Y | Y | N |
|------|---|-------|--------|---|---|---|---|---|

Venting

Outside Air Kit

| | | | | | | | | |
|---------|--|-------|-------|---|----|----|----|---|
| OA-RD-6 | Outside air elbow kit (used to offset outside air starting collar) | HTI 1 | \$ 60 | Y | 14 | 14 | 14 | Y |
|---------|--|-------|-------|---|----|----|----|---|

Venting Notes

Requires SL300 or 8" DuraPlus pipe with the DuraPlus base plate. See venting section

When using 8" DuraPlus use DV-6DP-IS attic insulation shield

Pioneer III

Includes:

- up to 85,175 Peak Btu/Hour Output
- Smart Burn Technology
- Single cast iron door
- 400 CFM fan system
- Fan air kit grill
- Welded steel firebox
- CAK4A
- Outside air hood
- Attic insulation shield
- 4.1 cu/ft firebox



Special Considerations:

- Certified to 2020 EPA emissions standards

Required to Complete - Sold Separately:

- Front
- Venting Boot and Flex Venting for Fan Air Kit
- Advanced Technology Product training required before product ships

| | | Disc. Code | MSRP USD | 004 IA | 010 PA | 014 CA | 016 NC | EXP |
|-----------------|---|------------|----------|--------|--------|--------|--------|-----|
| PIONEER-III-ARC | Wood Fireplace with Arch door, classic black | HTI 3 | \$ 6,029 | Y | Y | Y | 14 | N |
| PIONEER-III-REC | Wood Fireplace with Rectangular door, classic black | HTI 3 | \$ 6,029 | Y | Y | Y | 14 | N |

Fronts - Non-Operable (Required to Complete)

Forged Arch Front

| | | | | | | | | |
|------------|----------------------------------|-------|----------|---|---|---|----|---|
| DF-PIII-FA | Forged arch front, classic black | HTI 3 | \$ 1,399 | Y | Y | Y | 14 | N |
|------------|----------------------------------|-------|----------|---|---|---|----|---|

Mission Arch Front

| | | | | | | | | |
|------------|-----------------------------------|-------|--------|---|---|---|----|---|
| DF-PIII-MA | Mission arch front, classic black | HTI 3 | \$ 769 | Y | Y | Y | 21 | N |
|------------|-----------------------------------|-------|--------|---|---|---|----|---|

Mission Rectangular Front

| | | | | | | | | |
|------------|--|-------|--------|---|---|---|----|---|
| DF-PIII-MR | Mission rectangular front, classic black | HTI 3 | \$ 769 | Y | Y | Y | 14 | N |
|------------|--|-------|--------|---|---|---|----|---|



Forged Arch Front



Mission Arch Front



Mission Rectangular Front

Options & Accessories

Finishing Template

| | | | | | | | | |
|-----------|---|-------|--------|---|----|----|----|---|
| TMP-PIIIR | Reusable metal finishing template for the Pioneer III-REC | HTI 3 | \$ 289 | 8 | 21 | 14 | 14 | N |
| TMP-PIIIA | Reusable metal finishing template for the Pioneer III-ARC | HTI 3 | \$ 289 | 8 | 21 | 14 | 14 | N |

Heat Management

Heat Zone Kit

| | | | | | | | | |
|----------------|--|-------|--------|---|---|---|---|---|
| HEAT-ZONE-WD-C | Heat distribution kit (includes fan, grille cover, fireplace adaptor, and adjustment control) requires 6" vent for ducting | HTI 1 | \$ 399 | Y | Y | Y | Y | Y |
|----------------|--|-------|--------|---|---|---|---|---|

Floor Protector (HP)

Micore Hearth Extension - Hearth Extension

| | | | | | | | | | |
|------|---|-------|----|-----|---|---|---|---|---|
| HX4M | Hearth extension for all size models (70"x 20"x 1/2") - pack of 5 | HTI 1 | \$ | 429 | Y | Y | Y | Y | N |
|------|---|-------|----|-----|---|---|---|---|---|

Service Parts

Service Parts

| | | | | | | | | | |
|----------------|------------|-------|----|-----|---|----|----|----|---|
| LINTELBAR-PIII | LINTEL BAR | HTI 1 | \$ | 359 | 8 | 21 | 14 | 14 | Y |
|----------------|------------|-------|----|-----|---|----|----|----|---|

Venting Notes

Requires SL300 or 8" DuraPlus pipe with the DuraPlus base plate. See venting section

When using 8" DuraPlus use DV-6DP-IS attic insulation shield

Hearth & Home Technologies

Fireplace Outdoor - Gas - Single-Sided

Stocked Item/Lead Time
 004=Mt. Pleasant RDC
 010=Kutztown RDC
 014=Sacramento RDC
 016=Charlotte RDC
 EXP=Factory Expedite Program

Page printed 3/31/2025, 8:22:26 AM CDT
 Current pricing updated 03/30/2025

Prices in USD

Non-stock and custom product cannot be cancelled.

* Please Contact Who You Purchase This Through for MSRP Pricing

Customer is responsible for freight for orders made outside of assigned RDC facility.

Courtyard 36

Includes:

- Clean face & flush hearth design
- 55,000 BTUs (NG), 53,000 BTUs (LP)
- Stainless steel pull screens
- 36" X 30" viewing area
- Wall switch with outdoor control box
- UL/JLC Listed



Required to Complete - Sold Separately:

- Hearth Kit (GR-ODCOUG) & choice of log set (SD/HDLOGS-ODCOUG)
- Choice of refractory required for ODCOUG-36NR
- Units are built NG. Conversion kit required for LP.

| | | Disc. Code | MSRP USD | 004 IA | 010 PA | 014 CA | 016 NC | EXP |
|-------------|--|------------|----------|--------|--------|--------|--------|-----|
| ODCOUG-36NR | 36" Courtyard Outdoor Fireplace, refractory required | HTI 3 | \$ 2,569 | Y | Y | Y | Y | N |
| ODCOUG-36TS | 36" Courtyard Outdoor Fireplace, Traditional Stacked Concrete Refractory | HTI 3 | \$ 2,949 | Y | Y | Y | Y | N |

Hearth Kit (Required to Complete)

Hearth Kit

| | | | | | | | | |
|-----------|--------------------------------------|-------|--------|---|---|---|---|---|
| GR-ODCOUG | Stainless steel grate with lava rock | HTI 3 | \$ 369 | Y | Y | Y | Y | Y |
|-----------|--------------------------------------|-------|--------|---|---|---|---|---|

Gas Logs - Log Set Option (Required to Complete)

Log Set - Traditional

| | | | | | | | | |
|---------------|---|-------|--------|---|---|---|---|---|
| SDLOGS-ODCOUG | Standard definition log set, requires GR-ODCOUG to complete | HTI 3 | \$ 429 | Y | Y | Y | Y | Y |
| HDLOGS-ODCOUG | High definition log set, requires GR-ODCOUG to complete | HTI 3 | \$ 809 | Y | Y | Y | Y | Y |

Refractory (Required to Complete)

Courtyard Refractory for -NR Units

| | | | | | | | | |
|---------------|---|-------|--------|---|----|----|----|---|
| ODCOUG-36SSL | 36" Courtyard Outdoor Fireplace, Stainless Steel Refractory | HTI 3 | \$ 479 | Y | Y | Y | Y | Y |
| ODCOUG-36BTR | 36" Courtyard Outdoor Fireplace, Brown Traditional Refractory | HTI 3 | \$ 489 | Y | 14 | Y | Y | Y |
| ODCOUG-36GTR | 36" Courtyard Outdoor Fireplace, Gray Traditional Refractory | HTI 3 | \$ 489 | Y | 14 | Y | Y | Y |
| ODCOUG-36BKTR | 36" Courtyard Outdoor Fireplace, Black Traditional Refractory | HTI 3 | \$ 509 | | 14 | 14 | 14 | Y |
| ODCOUG-36BHR | 36" Courtyard Outdoor Fireplace, Brown Herringbone Refractory | HTI 3 | \$ 569 | Y | 14 | Y | Y | Y |
| ODCOUG-36GHR | 36" Courtyard Outdoor Fireplace, Gray Herringbone Refractory | HTI 3 | \$ 569 | Y | Y | Y | Y | Y |
| ODCOUG-36BKHR | 36" Courtyard Outdoor Fireplace, Black Herringbone Refractory | HTI 3 | \$ 589 | | 14 | 14 | 14 | Y |

LP Conversion Kit

Courtyard Conversion Kits

| | | | | | | | | |
|------------|---|-------|-------|---|----|----|----|---|
| ODCOUG-NGK | NG conversion kit for the Courtyard fireplace | HTI 3 | \$ 99 | 8 | 14 | 14 | 14 | Y |
| ODCOUG-LPK | LP conversion kit for the Courtyard fireplace | HTI 3 | \$ 99 | Y | Y | Y | Y | Y |

Firescreens

Courtyard Screen

| | | | | | | | | | |
|--------------|--|-------|----|-----|---|---|---|---|---|
| ODCOUG-36SCN | Framed mesh hang-on screen for Courtyard 36" | HTI 3 | \$ | 609 | Y | Y | Y | Y | Y |
|--------------|--|-------|----|-----|---|---|---|---|---|

Options & Accessories

Outdoor Gas Drain Pan

| | | | | | | | | | |
|--------------|--|-------|----|-----|---|----|----|----|---|
| ODGSDP-36 | 36" Outdoor Drain Pan | HTI 3 | \$ | 105 | Y | 14 | 14 | Y | Y |
| ODGSDPFLT-36 | 36" Outdoor Drain Pan for rubber roof installs | HTI 3 | \$ | 105 | 8 | 14 | 14 | 14 | Y |

Outdoor Vent Free Pan

| | | | | | | | | | |
|------------|---|-------|----|-----|---|---|---|---|---|
| ODCOUG-VFP | Vent Free pan for the Courtyard Outdoor Fireplace | HTI 3 | \$ | 131 | Y | Y | Y | Y | Y |
|------------|---|-------|----|-----|---|---|---|---|---|

Control, remotes, wall switches

Wired Wall Timer

| | | | | | | | | | |
|-----|--|-------|----|-----|---|---|---|---|---|
| WWT | Wall Control Panel (30, 60, 120 minutes) | HTI 3 | \$ | 118 | Y | Y | Y | Y | Y |
|-----|--|-------|----|-----|---|---|---|---|---|

Venting Notes

No venting is required with this unit

Courtyard 42

Includes:

- Clean face & flush hearth design
- 55,000 BTUs (NG), 53,000 BTUs (LP)
- Wall switch with outdoor control box
- 42" X 30" viewing area
- Stainless steel pull screens
- UL/ULC Listed



Required to Complete - Sold Separately:

- Hearth Kit (GR-ODCOUG) & choice of log set (SD/HDLOGS-ODCOUG)
- Choice of refractory required for ODCOUG-42NR
- Units are built NG. Conversion kit required for LP.

| | | Disc. Code | MSRP USD | 004 IA | 010 PA | 014 CA | 016 NC | EXP |
|-------------|--|------------|----------|--------|--------|--------|--------|-----|
| ODCOUG-42NR | 42" Courtyard Outdoor Fireplace, refractory required | HTI 3 | \$ 2,899 | Y | Y | Y | Y | N |
| ODCOUG-42TS | 42" Courtyard Outdoor Fireplace, Traditional Stacked Concrete Refractory | HTI 3 | \$ 3,279 | Y | Y | Y | Y | N |

Hearth Kit (Required to Complete)

Hearth Kit

| | | | | | | | | |
|-----------|--------------------------------------|-------|--------|---|---|---|---|---|
| GR-ODCOUG | Stainless steel grate with lava rock | HTI 3 | \$ 369 | Y | Y | Y | Y | Y |
|-----------|--------------------------------------|-------|--------|---|---|---|---|---|

Gas Logs - Log Set Option (Required to Complete)

Log Set - Traditional

| | | | | | | | | |
|---------------|---|-------|--------|---|---|---|---|---|
| SDLOGS-ODCOUG | Standard definition log set, requires GR-ODCOUG to complete | HTI 3 | \$ 429 | Y | Y | Y | Y | Y |
| HDLOGS-ODCOUG | High definition log set, requires GR-ODCOUG to complete | HTI 3 | \$ 809 | Y | Y | Y | Y | Y |

Refractory (Required to Complete)

Courtyard Refractory for -NR Units

| | | | | | | | | |
|---------------|---|-------|--------|---|----|----|----|---|
| ODCOUG-42SSL | 42" Courtyard Outdoor Fireplace, Stainless Steel Refractory | HTI 3 | \$ 489 | 8 | 14 | 14 | 14 | Y |
| ODCOUG-42GTR | 42" Courtyard Outdoor Fireplace, Gray Traditional Refractory | HTI 3 | \$ 529 | Y | 14 | Y | Y | Y |
| ODCOUG-42BTR | 42" Courtyard Outdoor Fireplace, Brown Traditional Refractory | HTI 3 | \$ 529 | Y | 14 | Y | Y | Y |
| ODCOUG-42BKTR | 42" Courtyard Outdoor Fireplace, Black Traditional Refractory | HTI 3 | \$ 549 | | 14 | 14 | 14 | Y |
| ODCOUG-42BHR | 42" Courtyard Outdoor Fireplace, Brown Herringbone Refractory | HTI 3 | \$ 599 | Y | 14 | Y | Y | Y |
| ODCOUG-42GHR | 42" Courtyard Outdoor Fireplace, Gray Herringbone Refractory | HTI 3 | \$ 599 | Y | Y | Y | Y | Y |
| ODCOUG-42BKHR | 42" Courtyard Outdoor Fireplace, Black Herringbone Refractory | HTI 3 | \$ 619 | | 14 | 14 | Y | Y |

LP Conversion Kit

Courtyard Conversion Kits

| | | | | | | | | |
|------------|---|-------|-------|---|----|----|----|---|
| ODCOUG-NGK | NG conversion kit for the Courtyard fireplace | HTI 3 | \$ 99 | 8 | 14 | 14 | 14 | Y |
| ODCOUG-LPK | LP conversion kit for the Courtyard fireplace | HTI 3 | \$ 99 | Y | Y | Y | Y | Y |

Firescreens

Courtyard Screen

| | | | | | | | | |
|--------------|--|-------|--------|---|---|---|---|---|
| ODCOUG-42SCN | Framed mesh hang-on screen for Courtyard 42" | HTI 3 | \$ 709 | Y | Y | Y | Y | Y |
|--------------|--|-------|--------|---|---|---|---|---|

Options & Accessories

Outdoor Gas Drain Pan

| | | | | | | | | |
|--------------|--|-------|--------|---|----|----|----|---|
| ODGSDPFLT-42 | 42" Outdoor Drain Pan for rubber roof installs | HTI 3 | \$ 121 | 8 | 14 | 14 | 14 | Y |
| ODGSDP-42 | 42" Outdoor Drain Pan | HTI 3 | \$ 121 | 8 | Y | 14 | 14 | Y |

Outdoor Vent Free Pan

| | | | | | | | | | |
|------------|---|-------|----|-----|---|---|---|---|---|
| ODCOUG-VFP | Vent Free pan for the Courtyard Outdoor Fireplace | HTI 3 | \$ | 131 | Y | Y | Y | Y | Y |
|------------|---|-------|----|-----|---|---|---|---|---|

Control, remotes, wall switches

Wired Wall Timer

| | | | | | | | | | |
|-----|--|-------|----|-----|---|---|---|---|---|
| WWT | Wall Control Panel (30, 60, 120 minutes) | HTI 3 | \$ | 118 | Y | Y | Y | Y | Y |
|-----|--|-------|----|-----|---|---|---|---|---|

Venting Notes

No venting is required with this unit

Lanai 48

Includes:

- Multicolored LED lights
- Crystal glass media
- Glass wind guard
- Wall control with 15' of wire and junction box
- Gas flex connector
- 55,000 BTUs (NG & LP)
- 48" x 17" viewing area
- UL/ULC listed



Required to Complete - Sold Separately: • Units are built NG. Conversion kit required for LP.

| | | Disc. Code | MSRP USD | 004 IA | 010 PA | 014 CA | 016 NC | EXP |
|-------------|--|------------|----------|--------|--------|--------|--------|-----|
| ODLANAIG-48 | 48" Lanai outdoor linear fireplace with IntelliFire Ignition, Single-sided | HTI 3 | \$ 4,439 | Y | Y | Y | Y | N |

Conversion Kit

Conversion Kit

| | | | | | | | | |
|----------------|-------------------------------|-------|--------|---|---|---|---|---|
| LPK-ODLANAIG48 | LP Conversion Kit - 48" Lanai | HTI 3 | \$ 129 | Y | Y | Y | Y | Y |
|----------------|-------------------------------|-------|--------|---|---|---|---|---|

Firescreens

Lanai Screen

| | | | | | | | | |
|----------------|-----------------------------------|-------|--------|---|---|---|---|---|
| ODLANAIG-48SCN | Framed Screen Barrier - 48" Lanai | HTI 3 | \$ 409 | Y | Y | Y | Y | Y |
|----------------|-----------------------------------|-------|--------|---|---|---|---|---|



Lanai Screen

Clean Face Kit

Lanai CF Kit

| | | | | | | | | |
|----------------|---------------------------------|-------|--------|---|----|----|----|---|
| ODLANAIG-48CFT | Clean Face Trim Kit - 48" Lanai | HTI 3 | \$ 279 | Y | 14 | 14 | 14 | Y |
|----------------|---------------------------------|-------|--------|---|----|----|----|---|

Gas Logs - Log Set Option

Log Accessories

| | | | | | | | | |
|------|-------------------|-------|--------|---|---|---|---|---|
| CDLS | Driftwood Log Set | HTI 1 | \$ 589 | Y | Y | Y | Y | Y |
|------|-------------------|-------|--------|---|---|---|---|---|

Media

Crushed Glass Media

| | | | | | | | | |
|-----------------|--|-------|--------|----|----|----|----|---|
| MEDIA-CLEAR-48 | Glass media, crystal (translucent white) | HTI 1 | \$ 259 | Y | Y | Y | Y | Y |
| MEDIA-RED-48 | Glass media, scarlet (red) | HTI 1 | \$ 369 | 14 | 21 | 14 | 14 | Y |
| MEDIA-EBONY-48 | Glass media, ebony (black) | HTI 1 | \$ 369 | Y | Y | Y | Y | Y |
| MEDIA-AMBER-48 | Glass media, amber | HTI 1 | \$ 369 | Y | Y | Y | Y | Y |
| MEDIA-COBALT-48 | Glass media, cobalt (blue) | HTI 1 | \$ 369 | Y | 21 | Y | 14 | Y |

MEDIA

| | | | | | | | | | |
|----------|-----------|-------|----|-----|---|---|---|---|---|
| STONEKIT | Stone Kit | HTI 1 | \$ | 149 | Y | Y | Y | Y | Y |
|----------|-----------|-------|----|-----|---|---|---|---|---|

Options & Accessories

Options & Accessories

| | | | | | | | | | |
|---------------|-----------------------|-------|----|-----|---|---|----|----|---|
| ODLANAIG-48DP | Drain Pan - 48" Lanai | HTI 3 | \$ | 229 | Y | Y | 14 | 14 | Y |
|---------------|-----------------------|-------|----|-----|---|---|----|----|---|

Venting Notes

No venting is required with this unit.

Lanai 60

Includes:

- Multicolored LED lights
- Crystal glass media
- Glass wind guard
- Wall control with 14' of wire and junction box
- Gas flex connector
- 65,000 BTUs (NG & LP)
- 60" x 17" viewing area
- UL/ULC listed



Required to Complete - Sold Separately: • Units are built NG. Conversion kit required for LP.

| | | Disc. Code | MSRP USD | 004 IA | 010 PA | 014 CA | 016 NC | EXP |
|-------------|--|------------|----------|--------|--------|--------|--------|-----|
| ODLANAIG-60 | 60" Lanai outdoor linear fireplace with IntelliFire Ignition, Single-sided | HTI 3 | \$ 4,789 | Y | Y | Y | Y | N |

Conversion Kit

Conversion Kit

| | | | | | | | | |
|----------------|-------------------------------|-------|--------|---|---|---|---|---|
| LPK-ODLANAIG60 | LP Conversion Kit - 60" Lanai | HTI 3 | \$ 149 | Y | Y | Y | Y | Y |
|----------------|-------------------------------|-------|--------|---|---|---|---|---|

Firescreens

Lanai Screen

| | | | | | | | | |
|----------------|-----------------------------------|-------|--------|---|---|----|----|---|
| ODLANAIG-60SCN | Framed Screen Barrier - 60" Lanai | HTI 3 | \$ 479 | Y | Y | 14 | 21 | Y |
|----------------|-----------------------------------|-------|--------|---|---|----|----|---|



Lanai Screen

Clean Face Kit

Lanai CF Kit

| | | | | | | | | |
|----------------|---------------------------------|-------|--------|---|----|---|----|---|
| ODLANAIG-60CFT | Clean Face Trim Kit - 60" Lanai | HTI 3 | \$ 299 | Y | 14 | Y | 14 | Y |
|----------------|---------------------------------|-------|--------|---|----|---|----|---|

Gas Logs - Log Set Option

Log Accessories

| | | | | | | | | |
|------|-------------------|-------|--------|---|---|---|---|---|
| CDLS | Driftwood Log Set | HTI 1 | \$ 589 | Y | Y | Y | Y | Y |
|------|-------------------|-------|--------|---|---|---|---|---|

Media

Crushed Glass Media

| | | | | | | | | |
|-----------------|--|-------|--------|----|----|----|----|---|
| MEDIA-CLEAR-60 | Glass media, crystal (translucent white) | HTI 1 | \$ 369 | Y | Y | Y | Y | Y |
| MEDIA-EBONY-60 | Glass media, ebony (black) | HTI 1 | \$ 479 | Y | Y | Y | Y | Y |
| MEDIA-RED-60 | Glass media, scarlet (red) | HTI 1 | \$ 479 | 14 | 21 | 14 | 14 | Y |
| MEDIA-AMBER-60 | Glass media, amber | HTI 1 | \$ 479 | Y | 21 | Y | 14 | Y |
| MEDIA-COBALT-60 | Glass media, cobalt (blue) | HTI 1 | \$ 479 | 14 | 21 | 14 | 14 | Y |

MEDIA

| | | | | | | | | | |
|----------|-----------|-------|----|-----|---|---|---|---|---|
| STONEKIT | Stone Kit | HTI 1 | \$ | 149 | Y | Y | Y | Y | Y |
|----------|-----------|-------|----|-----|---|---|---|---|---|

Options & Accessories

Options & Accessories

| | | | | | | | | | |
|---------------|-----------------------|-------|----|-----|---|----|----|----|---|
| ODLANAIG-60DP | Drain Pan - 60" Lanai | HTI 3 | \$ | 249 | Y | 21 | 14 | 14 | Y |
|---------------|-----------------------|-------|----|-----|---|----|----|----|---|

Venting Notes

No venting is required with this unit.

Vesper 36

Includes:

- Stainless steel construction
- Optional mesh cabinet style doors
- 38,000 BTUs
- 36" x 27" viewing area
- UL/ULC Listed



Required to Complete - Sold Separately: • Add the Lumonessen outdoor burner LUM-OD-PM (LP) or LUM-OD-NM (NG) • Select a log set: Mezmer logs, Mezmer split logs, or Mountain Oak logs

| | | Disc. Code | MSRP USD | 004 IA | 010 PA | 014 CA | 016 NC | EXP |
|----------|--|------------|----------|--------|--------|--------|--------|-----|
| VOFB36-T | 36" Vesper Outdoor Firebox - Traditional Concrete Refractory | HTI 3 | \$ 1,289 | Y | 14 | 14 | Y | N |
| VOFB36-H | 36" Vesper Outdoor Firebox - Herringbone Concrete Refractory | HTI 3 | \$ 1,319 | Y | 14 | 14 | Y | N |

Gas Logs - Log Set Option (Required to Complete)

Mezmer

| | | | | | | | | |
|---------|--------------------|-------|--------|---|---|---|---|---|
| MZMR-24 | 24" Mezmer Log Set | HTI 1 | \$ 229 | Y | Y | Y | Y | Y |
|---------|--------------------|-------|--------|---|---|---|---|---|

Mezmer Split

| | | | | | | | | |
|-----------|--------------------------|-------|--------|---|---|----|---|---|
| MZMRSP-24 | 24" Mezmer Split Log Set | HTI 1 | \$ 229 | Y | Y | 14 | Y | Y |
|-----------|--------------------------|-------|--------|---|---|----|---|---|

Mountain Oak

| | | | | | | | | |
|----------|--------------------------|-------|--------|---|---|---|---|---|
| MTNOK-24 | 24" Mountain Oak Log Set | HTI 1 | \$ 229 | Y | Y | Y | Y | Y |
|----------|--------------------------|-------|--------|---|---|---|---|---|



Mezmer



Mezmer Split



Mountain Oak

Gas Logs - Burner Option Outdoor (Required to Complete)

Lumonessen Outdoor

| | | | | | | | | |
|-----------|--|-------|--------|---|----|----|---|---|
| LUM-OD-NM | Lumonessen Outdoor Burner: Manual Ignition, NG: 19,000 MIN - 38,000 MAX BTUs | HTI 3 | \$ 819 | Y | Y | Y | Y | Y |
| LUM-OD-PM | Lumonessen Outdoor Burner: Manual Ignition, LP: 31,000 MIN - 38,000 MAX BTUs | HTI 3 | \$ 819 | Y | 14 | 14 | Y | Y |



Lumonessen Outdoor

Mesh Doors - Operable

Mesh Door

| | | | | | | | | |
|-----------|---|-------|----------|---|----|----|---|---|
| VOFBSD-36 | 36" Vesper Stainless Steel Mesh Cabinet Style Doors | HTI 3 | \$ 1,099 | 8 | 14 | 14 | Y | Y |
|-----------|---|-------|----------|---|----|----|---|---|



Mesh Door

Options & Accessories

Outdoor Gas Drain Pan

| | | | | | | | | |
|--------------|--|-------|--------|---|----|----|----|---|
| ODGSDP-36 | 36" Outdoor Drain Pan | HTI 3 | \$ 105 | Y | 14 | 14 | Y | Y |
| ODGSDPFLT-36 | 36" Outdoor Drain Pan for rubber roof installs | HTI 3 | \$ 105 | 8 | 14 | 14 | 14 | Y |

Venting Notes

Venting is not required with this unit

Vesper 42

Includes:

- Stainless steel construction
- Optional mesh cabinet style doors
- 38,000 BTUs
- 42" x 27" viewing area
- UL/ULC Listed



Required to Complete - Sold Separately: • Add the Lumonessen outdoor burner LUM-OD-PM (LP) or LUM-OD-NM (NG) • Select a log set: Mezmer logs, Mezmer split logs, or Mountain Oak logs

| | | Disc. Code | MSRP USD | 004 IA | 010 PA | 014 CA | 016 NC | EXP |
|----------|---|------------|----------|--------|--------|--------|--------|-----|
| VOFB42-T | 42" Vesper Outdoor Firebox - Traditional Refractory | HTI 3 | \$ 1,859 | Y | 14 | Y | Y | N |
| VOFB42-H | 42" Vesper Outdoor Firebox - Herringbone Refractory | HTI 3 | \$ 1,869 | Y | 14 | 14 | Y | N |

Gas Logs - Log Set Option (Required to Complete)

Mezmer

| | | | | | | | | |
|---------|--------------------|-------|--------|---|----|----|---|---|
| MZMR-30 | 30" Mezmer Log Set | HTI 1 | \$ 259 | Y | 14 | 14 | Y | Y |
|---------|--------------------|-------|--------|---|----|----|---|---|

Mezmer Split

| | | | | | | | | |
|-----------|--------------------------|-------|--------|---|----|----|---|---|
| MZMRSP-30 | 30" Mezmer Split Log Set | HTI 1 | \$ 259 | Y | 14 | 14 | Y | Y |
|-----------|--------------------------|-------|--------|---|----|----|---|---|

Mountain Oak

| | | | | | | | | |
|----------|--------------------------|-------|--------|---|----|----|---|---|
| MTNOK-30 | 30" Mountain Oak Log Set | HTI 1 | \$ 259 | Y | 14 | 14 | Y | Y |
|----------|--------------------------|-------|--------|---|----|----|---|---|



Mezmer



Mezmer Split



Mountain Oak

Gas Logs - Burner Option Outdoor (Required to Complete)

Lumonessen Outdoor

| | | | | | | | | |
|-----------|--|-------|--------|---|----|----|---|---|
| LUM-OD-NM | Lumonessen Outdoor Burner: Manual Ignition, NG: 19,000 MIN - 38,000 MAX BTUs | HTI 3 | \$ 819 | Y | Y | Y | Y | Y |
| LUM-OD-PM | Lumonessen Outdoor Burner: Manual Ignition, LP: 31,000 MIN - 38,000 MAX BTUs | HTI 3 | \$ 819 | Y | 14 | 14 | Y | Y |



Lumonessen Outdoor

Mesh Doors - Operable

Mesh Door

| | | | | | | | | |
|-----------|---|-------|----------|---|----|----|----|---|
| VOFBSD-42 | 42" Vesper Stainless Steel Mesh Cabinet Style Doors | HTI 3 | \$ 1,219 | Y | 14 | 14 | 14 | Y |
|-----------|---|-------|----------|---|----|----|----|---|



Mesh Door

Options & Accessories

Outdoor Gas Drain Pan

| | | | | | | | | |
|--------------|--|-------|--------|---|----|----|----|---|
| ODGSDP-42 | 42" Outdoor Drain Pan | HTI 3 | \$ 121 | 8 | Y | 14 | 14 | Y |
| ODGSDPFLT-42 | 42" Outdoor Drain Pan for rubber roof installs | HTI 3 | \$ 121 | 8 | 14 | 14 | 14 | Y |

Venting Notes

No venting is required with this unit

Hearth & Home Technologies

Fireplace Outdoor - Wood - Single-Sided

Stocked Item/Lead Time

004=Mt. Pleasant RDC
010=Kutztown RDC
014=Sacramento RDC
016=Charlotte RDC

EXP=Factory Expedite Program

Page printed 3/31/2025, 8:22:26 AM CDT
Current pricing updated 03/30/2025

* Please Contact Who You Purchase This Through for MSRP Pricing

Prices in USD

Non-stock and custom product cannot be cancelled.

Customer is responsible for freight for orders made outside of assigned RDC facility.

Castlewood 42

Includes:

- Expansive 38" high firebox opening
- Stainless steel mesh curtain screens
- Black grate
- Transition collar
- Dual gas knockouts
- Outside air hoods
- 41-7/8" x 38" viewing area
- UL & ULC listed



Required to Complete - Sold Separately: • Brick interior panels for an authentic masonry look

| | | Disc. Code | MSRP USD | 004 IA | 010 PA | 014 CA | 016 NC | EXP |
|-----------------|-------------------------------------|------------|----------|--------|--------|--------|--------|-----|
| ODCASTLEWD-42-B | 42" Castlewood Outdoor Wood Firebox | HTI 3 | \$ 3,489 | Y | Y | 14 | Y | N |

Brick Panels (Required to Complete)

Castlewood 42-B Refractory

| | | | | | | | | |
|----------|---|-------|----------|---|---|---|---|---|
| WDRV-42T | 42" Wood Traditional Stacked Refractory-Antler Velvet | HTI 3 | \$ 1,099 | Y | Y | Y | Y | N |
| WDRV-42H | 42" Wood Herringbone Refractory-Antler Velvet | HTI 3 | \$ 1,529 | Y | Y | Y | Y | N |

Glass Doors - Operable

Outdoor Glass Bi-Fold Door

| | | | | | | | | |
|------------|---|-------|----------|---|----|----|----|---|
| ODGF42BZ-B | Premium outdoor glass bi-fold door with stainless steel construction, bronze finish | HTI 3 | \$ 2,519 | 8 | 14 | 28 | 14 | Y |
|------------|---|-------|----------|---|----|----|----|---|



Outdoor Glass Bi-Fold Door

Gas Logs - Log Set Option**Fireside Grand Oak Outdoor Gas Log Sets**

| | | | | | | | | |
|-----------------|---|-------|----------|----|----|----|----|---|
| OGO324-MTCH-HK | 24" Match Light Outdoor Grand Oaks Burner/Hearth Kit - 3 Tier (NG only) | HTI 3 | \$ 1,549 | 21 | 14 | 28 | 21 | Y |
| OGO324-IPING-HK | 24" IPI Outdoor Grand Oaks NG Burner/Hearth Kit - 3 Tier | HTI 3 | \$ 1,739 | Y | 21 | 14 | 21 | Y |
| OGO324-IPILP-HK | 24" IPI Outdoor Grand Oaks LP Burner/Hearth Kit - 3 Tier | HTI 3 | \$ 1,739 | 21 | 28 | 28 | 21 | Y |

Grand Oak Logs 324

| | | | | | | | | |
|-------|---------------------------------------|-------|--------|----|----|----|---|---|
| GO324 | 24" Grand Oak Log Set - 11pcs, 3 Tier | HTI 3 | \$ 619 | 21 | 14 | 14 | Y | N |
|-------|---------------------------------------|-------|--------|----|----|----|---|---|



Fireside Grand Oak Outdoor
Gas Log Sets

Mortar**Refractory Mortar**

| | | | | | | | | |
|---------|---|-------|-------|---|---|---|---|---|
| MMMORTR | 10 lbs. Mortar (TRAD: 1 required, HERR: 2 required) | HTI 1 | \$ 99 | Y | Y | Y | Y | N |
|---------|---|-------|-------|---|---|---|---|---|

Options & Accessories**Outdoor Gas Drain Pan**

| | | | | | | | | |
|-----------------|------------------------------|-------|--------|---|----|----|----|---|
| ODCASTLEWD-42DP | Drain Pan for 42" Castlewood | HTI 3 | \$ 219 | 8 | 14 | 14 | 14 | Y |
|-----------------|------------------------------|-------|--------|---|----|----|----|---|

Venting**SL1100 Wood Pipe - Single Pack - Chimney Air Kits/Flex Duct Dimensions: 11" Inner / 13" Outer**

| | | | | | | | | |
|-------|--|-------|--------|---|---|----|----|---|
| CAK8A | Chimney air kit (For use with BIR42 and RUTHERFORD-42, ODCASTLEWD-42) | HTI 1 | \$ 153 | Y | Y | 14 | 14 | Y |
|-------|--|-------|--------|---|---|----|----|---|

Venting Notes

Requires SL1100 series pipe. See Venting section.

Cooling hood or all non-combustible materials are required.

Canada: Requires SL400 series pipe, SLA10 and CAK8A. See Venting section.

Cottagewood 36

Includes:

- Mineral Gray Traditional or Herringbone refractory liners
- Dual gas knockouts
- Convenient damper control
- Stainless steel facings
- Stainless steel safety screens
- Outside air kit
- Black grate
- UL/ULC listed
- Viewing area: 36" x 28 1/2"



Required to Complete - Sold Separately: • Flex Duct

| | | Disc. Code | MSRP USD | 004 IA | 010 PA | 014 CA | 016 NC | EXP |
|-------------|---|------------|----------|--------|--------|--------|--------|-----|
| ODCTGWD-36 | Cottagewood 36" Outdoor Wood-Burning Fireplace with Gray Traditional refractory | HTI 3 | \$ 3,089 | Y | 14 | 14 | 14 | N |
| ODCTGWD-36H | Cottagewood 36" Outdoor Wood-Burning Fireplace with Gray Herringbone refractory | HTI 3 | \$ 3,129 | Y | 14 | 14 | 14 | N |

Venting (Required to Complete)

Insulated Flex Duct - Chimney Air Kits/Flex Duct

| | | | | | | | | |
|-----|---|-------|-------|---|---|----|---|---|
| ID4 | 4" (100mm) insulated flex duct for outside air - includes two 42" (1065mm) sections | HTI 1 | \$ 87 | Y | Y | 14 | Y | Y |
|-----|---|-------|-------|---|---|----|---|---|

Uninsulated Flex Duct - Chimney Air Kits/Flex Duct

| | | | | | | | | |
|-----|---|-------|-------|---|---|---|---|---|
| UD4 | 4" (100mm) uninsulated flex duct for outside air - includes two 42" (1065mm) sections | HTI 1 | \$ 56 | Y | Y | Y | Y | Y |
|-----|---|-------|-------|---|---|---|---|---|

4" Insulated Flex Duct

| | | | | | | | | |
|-------------|--|-------|-------|---|----|----|----|---|
| FLEXDUCT4AI | 4" (102mm) insulated flex duct for outside air - 25' | HTI 1 | \$ 79 | Y | 14 | 14 | 21 | N |
|-------------|--|-------|-------|---|----|----|----|---|

SL400 Series Pipe - Term Kits & Acc - Sng Pk - Chimney Air Kits/Flex Duct

| | | | | | | | | |
|-------|---|-------|--------|---|---|----|----|---|
| CAK5A | Chimney air kit for SL1100 and SL400 series pipe (required in Canada) | HTI 1 | \$ 142 | Y | Y | 14 | 14 | Y |
|-------|---|-------|--------|---|---|----|----|---|

Doors - Operable

Cottagewood Glass Doors

| | | | | | | | | |
|----------|---|-------|--------|---|----|----|----|---|
| DM6036-S | 36" stainless steel bi-fold doors for the 36" Cottagewood | HTI 3 | \$ 509 | 8 | 14 | 14 | 14 | Y |
|----------|---|-------|--------|---|----|----|----|---|

Gas Logs - Log Set Option

Fireside Grand Oak Outdoor Gas Log Sets

| | | | | | | | | |
|-----------------|---|-------|----------|----|----|----|----|---|
| OGO324-MTCH-HK | 24" Match Light Outdoor Grand Oaks Burner/Hearth Kit - 3 Tier (NG only) | HTI 3 | \$ 1,549 | 21 | 14 | 28 | 21 | Y |
| OGO324-IPING-HK | 24" IPI Outdoor Grand Oaks NG Burner/Hearth Kit - 3 Tier | HTI 3 | \$ 1,739 | Y | 21 | 14 | 21 | Y |
| OGO324-IPILP-HK | 24" IPI Outdoor Grand Oaks LP Burner/Hearth Kit - 3 Tier | HTI 3 | \$ 1,739 | 21 | 28 | 28 | 21 | Y |

Fireside Realwood Gas Log Sets

| | | | | | | | | |
|--------|---|-------|--------|----|----|---|----|---|
| FRW124 | 24" Fireside Realwood refractory cement log set (order hearth kit separately) | HTI 3 | \$ 239 | 21 | 14 | Y | 21 | N |
|--------|---|-------|--------|----|----|---|----|---|

Grand Oak Logs 324

| | | | | | | | | |
|-------|---------------------------------------|-------|--------|----|----|----|---|---|
| GO324 | 24" Grand Oak Log Set - 11pcs, 3 Tier | HTI 3 | \$ 619 | 21 | 14 | 14 | Y | N |
|-------|---------------------------------------|-------|--------|----|----|----|---|---|



Fireside Grand Oak Outdoor Gas Log Sets



Fireside Realwood Gas Log Sets

Gas Logs - Burner Option Indoor

Fireside Realwood Outdoor Gas Log Sets

| | | | | | | | | |
|-----------|--|-------|----------|----|----|----|----|---|
| OD-24NG | 24" matchlight hearth kit for outdoor fireplaces - 69,000 Btu/Hour Input (NG only) | HTI 3 | \$ 1,059 | 21 | 21 | 21 | 21 | N |
| ODSP-24LP | 24" safety pilot hearth kit for outdoor fireplaces - 61,000 Btu/Hour input LP (Note: Controls are located on the right and may offset the unit in the fireplace. Choose hearth size accordingly. See installation manual for hearth dimensions.) | HTI 3 | \$ 1,139 | 21 | 21 | 21 | 21 | N |



Fireside Realwood Outdoor Gas Log Sets

Miscellaneous

Cottagewood Drain Pans

| | | | | | | | | |
|--------------|-----------------------------------|-------|--------|---|----|----|----|---|
| ODCTGWD-DP36 | Drain pan for the 36" Cottagewood | HTI 3 | \$ 179 | 8 | 14 | 14 | 14 | Y |
|--------------|-----------------------------------|-------|--------|---|----|----|----|---|

Freestanding Kits

| | | | | | | | | |
|---------------|---|-------|--------|---|----|----|----|---|
| ODCTGWD-FSK36 | Extended smoke shelf for use when unit is installed as a freestanding fireplace and the venting is reduced below the required minimum. See install manual for requirements. | HTI 3 | \$ 189 | 8 | 14 | 14 | 14 | Y |
|---------------|---|-------|--------|---|----|----|----|---|

Venting Notes

Requires SL1100 series chimney. See Venting section.

Extended smoke shield in the ODCTGWD-FSK (36/42) is for freestanding fireplace installs and reduces min vent height to 9.5'. See install manual for all requirements.

Canada uses SL400 series chimney and requires SLA-10 and CAK5A

Cottagewood 42

Includes:

- Mineral Gray Traditional or Herringbone refractory liners
- Dual gas knockouts
- Convenient damper control
- Stainless steel facings
- Stainless steel safety screens
- Outside air kit
- Black grate
- UL/ULC listed
- Viewing area: 42" x 28 1/2"



Required to Complete - Sold Separately: • Flex Duct

| | | Disc. Code | MSRP USD | 004 IA | 010 PA | 014 CA | 016 NC | EXP |
|-------------|---|------------|----------|--------|--------|--------|--------|-----|
| ODCTGWD-42 | Cottagewood 42" Outdoor Wood-Burning Fireplace with Gray Traditional refractory | HTI 3 | \$ 3,189 | Y | Y | 14 | Y | N |
| ODCTGWD-42H | Cottagewood 42" Outdoor Wood-Burning Fireplace with Gray Herringbone refractory | HTI 3 | \$ 3,239 | Y | 21 | 14 | Y | N |

Venting (Required to Complete)

Insulated Flex Duct - Chimney Air Kits/Flex Duct

| | | | | | | | | |
|-----|---|-------|-------|---|---|----|---|---|
| ID4 | 4" (100mm) insulated flex duct for outside air - includes two 42" (1065mm) sections | HTI 1 | \$ 87 | Y | Y | 14 | Y | Y |
|-----|---|-------|-------|---|---|----|---|---|

Uninsulated Flex Duct - Chimney Air Kits/Flex Duct

| | | | | | | | | |
|-----|---|-------|-------|---|---|---|---|---|
| UD4 | 4" (100mm) uninsulated flex duct for outside air - includes two 42" (1065mm) sections | HTI 1 | \$ 56 | Y | Y | Y | Y | Y |
|-----|---|-------|-------|---|---|---|---|---|

4" Insulated Flex Duct

| | | | | | | | | |
|-------------|--|-------|-------|---|----|----|----|---|
| FLEXDUCT4AI | 4" (102mm) insulated flex duct for outside air - 25' | HTI 1 | \$ 79 | Y | 14 | 14 | 21 | N |
|-------------|--|-------|-------|---|----|----|----|---|

SL400 Series Pipe - Term Kits & Acc - Sng Pk - Chimney Air Kits/Flex Duct

| | | | | | | | | |
|-------|---|-------|--------|---|---|----|----|---|
| CAK5A | Chimney air kit for SL1100 and SL400 series pipe (required in Canada) | HTI 1 | \$ 142 | Y | Y | 14 | 14 | Y |
|-------|---|-------|--------|---|---|----|----|---|

Doors - Operable

Cottagewood Glass Doors

| | | | | | | | | |
|----------|---|-------|--------|---|----|----|----|---|
| DM8042-S | 42" stainless steel bi-fold doors for the 42" Cottagewood | HTI 3 | \$ 649 | Y | 14 | 14 | 14 | Y |
|----------|---|-------|--------|---|----|----|----|---|

Gas Logs - Log Set Option

Fireside Grand Oak Outdoor Gas Log Sets

| | | | | | | | | |
|-----------------|---|-------|----------|----|----|----|----|---|
| OGO324-MTCH-HK | 24" Match Light Outdoor Grand Oaks Burner/Hearth Kit - 3 Tier (NG only) | HTI 3 | \$ 1,549 | 21 | 14 | 28 | 21 | Y |
| OGO324-IPING-HK | 24" IPI Outdoor Grand Oaks NG Burner/Hearth Kit - 3 Tier | HTI 3 | \$ 1,739 | Y | 21 | 14 | 21 | Y |
| OGO324-IPILP-HK | 24" IPI Outdoor Grand Oaks LP Burner/Hearth Kit - 3 Tier | HTI 3 | \$ 1,739 | 21 | 28 | 28 | 21 | Y |

Grand Oak Logs 324

| | | | | | | | | |
|-------|---------------------------------------|-------|--------|----|----|----|---|---|
| GO324 | 24" Grand Oak Log Set - 11pcs, 3 Tier | HTI 3 | \$ 619 | 21 | 14 | 14 | Y | N |
|-------|---------------------------------------|-------|--------|----|----|----|---|---|



Fireside Grand Oak Outdoor Gas Log Sets

Gas Logs - Burner Option Indoor

Fireside Realwood Outdoor Gas Log Sets

| | | | | | | | | |
|-----------|---|-------|----------|----|----|----|----|---|
| OD-24NG | 24" matchlight hearth kit for outdoor fireplaces - 69,000 Btu/Hour Input (NG only) | HTI 3 | \$ 1,059 | 21 | 21 | 21 | 21 | N |
| ODSP-24LP | 24" safety pilot hearth kit for outdoor fireplaces - 61,000 Btu/Hour input LP (Note: Controls are located on the right and may offset the unit in the fireplace. Choose hearth size accordingly. See installation manual for hearth dimensions.) | HTI 3 | \$ 1,139 | 21 | 21 | 21 | 21 | N |



Fireside Realwood Outdoor Gas Log Sets

Miscellaneous

Cottagewood Drain Pans

| | | | | | | | | |
|--------------|-----------------------------------|-------|--------|---|----|----|----|---|
| ODCTGWD-DP42 | Drain pan for the 42" Cottagewood | HTI 3 | \$ 199 | 8 | 14 | 14 | 14 | Y |
|--------------|-----------------------------------|-------|--------|---|----|----|----|---|

Freestanding Kits

| | | | | | | | | |
|---------------|---|-------|--------|---|----|----|----|---|
| ODCTGWD-FSK42 | Extended smoke shelf for use when unit is installed as a freestanding fireplace and the venting is reduced below the required minimum. See install manual for requirements. | HTI 3 | \$ 209 | 8 | 14 | 14 | 14 | Y |
|---------------|---|-------|--------|---|----|----|----|---|

Venting Notes

Requires SL1100 series chimney. See Venting section.

When utilizing extended smoke shield in the ODCTGWD-FSK (36/42), the unit is installed as a freestanding fireplace and the venting can be reduced to 9.5' min. See install manual for requirements.

Canada uses SL400 series chimney and requires SLA-10 and CAK5A

Villawood 36

Includes:

- Traditional or herringbone brick interior
- Grate
- Stainless steel mesh curtain screens
- Dual gas knockouts
- Outside air standard
- UL & ULC listed
- 36" x 20-7/8" viewing area



No additional items required to complete.

| | | Disc. Code | MSRP USD | 004 IA | 010 PA | 014 CA | 016 NC | EXP |
|---------------|---|------------|----------|--------|--------|--------|--------|-----|
| ODVILLA-36T-B | 36" Outdoor Villa Wood Firebox - Traditional Refractory | HTI 3 | \$ 1,539 | Y | | Y | Y | N |
| ODVILLA-36H-B | 36" Outdoor Villa Wood Firebox - Herringbone Refractory | HTI 3 | \$ 1,589 | Y | | | Y | N |

Doors - Operable

Villawood Glass Door 36

| | | | | | | | | |
|----------|-------------------------|-------|--------|---|----|----|----|---|
| ODVGF-36 | 36" Bi-fold glass doors | HTI 3 | \$ 589 | Y | 14 | 14 | 14 | Y |
|----------|-------------------------|-------|--------|---|----|----|----|---|



Villawood Glass Door 36

Gas Logs - Log Set Option

Fireside Realwood Gas Log Sets

| | | | | | | | | |
|--------|---|-------|--------|---|----|---|----|---|
| FRW118 | 18" Fireside Realwood refractory cement log set (order hearth kit separately) | HTI 3 | \$ 199 | Y | 14 | Y | 14 | N |
|--------|---|-------|--------|---|----|---|----|---|

Fireside Supreme Oak Gas Logs

| | | | | | | | | |
|-------|--|-------|--------|---|----|----|----|---|
| FSO18 | 18" Fireside Supreme Oak refractory cement log set (order hearth kit separately) | HTI 3 | \$ 509 | Y | 14 | 14 | 21 | N |
|-------|--|-------|--------|---|----|----|----|---|



Fireside Realwood Gas Log Sets



Fireside Supreme Oak Gas Logs

Gas Logs - Burner Option Indoor

Fireside Realwood Outdoor Gas Log Sets

| | | | | | | | | |
|-----------|--|-------|----------|----|----|----|----|---|
| OD-18NG | 18" matchlight hearth kit for outdoor fireplaces - 62,000 Btu/Hour Input (NG only) | HTI 3 | \$ 889 | 21 | 21 | 21 | 21 | N |
| ODSP-18LP | 18" safety pilot hearth kit for outdoor fireplaces - 55,000 Btu/Hour Input LP (Note: Controls are located on the right and may offset the unit in the fireplace. Choose hearth size accordingly. See installation manual for hearth dimensions.) | HTI 3 | \$ 1,019 | 21 | 21 | 21 | 21 | N |



Fireside Realwood Outdoor Gas Log Sets

Options & Accessories

Options & Accessories

| | | | | | | | | |
|--------------|---------------------------|-------|--------|---|----|----|----|---|
| ODVILLA-36DP | Drain Pan for 36" ODVILLA | HTI 3 | \$ 169 | 8 | 14 | 14 | 14 | Y |
|--------------|---------------------------|-------|--------|---|----|----|----|---|

Venting Notes

Requires SL300 series pipe. See Venting section.

Villawood 42

Includes:

- Traditional or herringbone brick interior
- Grate
- Stainless steel mesh curtain screens
- Dual gas knockouts
- Outside air standard
- UL & ULC listed
- 42" x 20-7/8" viewing area



No additional items required to complete.

| | | Disc. Code | MSRP USD | 004 IA | 010 PA | 014 CA | 016 NC | EXP |
|---------------|---|------------|----------|--------|--------|--------|--------|-----|
| ODVILLA-42T-B | 42" Outdoor Villa Wood Firebox - Traditional Refractory | HTI 3 | \$ 1,759 | Y | Y | Y | Y | N |
| ODVILLA-42H-B | 42" Outdoor Villa Wood Firebox - Herringbone Refractory | HTI 3 | \$ 1,809 | Y | | Y | Y | N |

Doors - Operable

Villawood Glass Door 42

| | | | | | | | | |
|----------|-------------------------|-------|--------|---|----|----|----|---|
| ODVGF-42 | 42" Bi-fold glass doors | HTI 3 | \$ 729 | Y | 14 | 14 | 14 | Y |
|----------|-------------------------|-------|--------|---|----|----|----|---|



Villawood Glass Door 42

Gas Logs - Log Set Option

Fireside Realwood Gas Log Sets

| | | | | | | | | |
|--------|---|-------|--------|----|----|---|----|---|
| FRW124 | 24" Fireside Realwood refractory cement log set (order hearth kit separately) | HTI 3 | \$ 239 | 21 | 14 | Y | 21 | N |
|--------|---|-------|--------|----|----|---|----|---|

Fireside Supreme Oak Gas Logs

| | | | | | | | | |
|-------|--|-------|--------|----|----|----|----|---|
| FSO24 | 24" Fireside Supreme Oak refractory cement log set (order hearth kit separately) | HTI 3 | \$ 549 | 21 | 14 | 21 | 21 | N |
| FSO30 | 30" Fireside Supreme Oak refractory cement log set (order hearth kit separately) | HTI 3 | \$ 589 | 21 | 14 | 14 | 21 | N |



Fireside Realwood Gas Log Sets



Fireside Supreme Oak Gas Logs

Gas Logs - Burner Option Indoor

Fireside Realwood Outdoor Gas Log Sets

| | | | | | | | | |
|-----------|--|-------|----------|----|----|----|----|---|
| OD-24NG | 24" matchlight hearth kit for outdoor fireplaces - 69,000 Btu/Hour Input (NG only) | HTI 3 | \$ 1,059 | 21 | 21 | 21 | 21 | N |
| ODSP-24LP | 24" safety pilot hearth kit for outdoor fireplaces - 61,000 Btu/Hour input LP (Note: Controls are located on the right and may offset the unit in the fireplace. Choose hearth size accordingly. See installation manual for hearth dimensions.) | HTI 3 | \$ 1,139 | 21 | 21 | 21 | 21 | N |



Fireside Realwood Outdoor Gas Log Sets

Options & Accessories

Options & Accessories

| | | | | | | | | |
|--------------|---------------------------|-------|--------|---|----|----|----|---|
| ODVILLA-42DP | Drain Pan for 36" ODVILLA | HTI 3 | \$ 179 | 8 | 14 | 14 | 14 | Y |
|--------------|---------------------------|-------|--------|---|----|----|----|---|

Venting Notes

Requires SL300 series pipe. See Venting section.

Hearth & Home Technologies

Fireplace Outdoor - Gas - Multi-Sided

Stocked Item/Lead Time
 004=Mt. Pleasant RDC
 010=Kutztown RDC
 014=Sacramento RDC
 016=Charlotte RDC
 EXP=Factory Expedite Program

Page printed 3/31/2025, 8:22:26 AM CDT
 Current pricing updated 03/30/2025

Prices in USD

Non-stock and custom product cannot be cancelled.

* Please Contact Who You Purchase This Through for MSRP Pricing

Customer is responsible for freight for orders made outside of assigned RDC facility.

Fortress 36 Indoor/Outdoor See-Through Gas Fireplace

Includes:

- Anti-reflective glass
- Touch screen remote control (RC400)
- Halogen accent lights
- Factory installed outdoor kit
- Both Indoor and Outdoor Screen
- 56,000-38,000 BTUs (NG)
- 59,000-44,000 BTUs (LP)
- 36" x 30" viewing area
- CSA design certified
- Not available for sale in Rhode Island



Required to Complete - Sold Separately: • Traditional or herringbone brick interior. • Units are built NG. Conversion kit required for LP.

| | | Disc. Code | MSRP USD | 004 IA | 010 PA | 014 CA | 016 NC | EXP |
|------------|---|------------|-----------|--------|--------|--------|--------|-----|
| ODFORTG-36 | Fortress indoor/outdoor gas fireplace with IntelliFire Touch ignition system, see-through | HTI 3 | \$ 10,079 | Y | Y | Y | Y | N |

Brick Panels (Required to Complete)

Fortress Brick Panels

| | | | | | | | | |
|--------------|---------------------------------------|-------|--------|---|---|----|---|---|
| ODFORTG36-IT | Fortress traditional brick refractory | HTI 3 | \$ 459 | Y | Y | Y | Y | N |
| ODFORTG36-IH | Fortress herringbone brick refractory | HTI 3 | \$ 519 | Y | Y | 14 | Y | N |

Conversion Kit

Conversion Kit

| | | | | | | | | |
|----------------|--------------------------------|-------|-------|---|---|---|---|---|
| LPK-ODFORTG-36 | LP conversion kit for Fortress | HTI 3 | \$ 99 | Y | Y | Y | Y | Y |
|----------------|--------------------------------|-------|-------|---|---|---|---|---|

Control, remotes, wall switches

IntelliFire app

| | | | | | | | | |
|---------|---|-------|--------|---|---|---|---|---|
| IFT-WFM | IntelliFire Wi-Fi Module that works with the IntelliFire iOS and Android app. Use to control all the features of your fireplace via a smart device. An RC400, RC450 or RC150 is required for thermostat control | HTI 1 | \$ 229 | Y | Y | Y | Y | Y |
|---------|---|-------|--------|---|---|---|---|---|

Remote/Wall Switch/Wall Thermostat

| | | | | | | | | |
|-----------|--|-------|--------|---|----|----|---|---|
| IFT-RC150 | IntelliFire Touch white wireless wall switch (on/off, cold climate, battery strength | HTI 1 | \$ 121 | Y | 14 | 14 | Y | Y |
|-----------|--|-------|--------|---|----|----|---|---|

Touch Screen Remote

| | | | | | | | | |
|-----------|---|-------|--------|---|---|---|---|---|
| IFT-RC400 | IntelliFire Touch black remote control, docking station and auxiliary control module (on/off, flame height, thermostat mode, fan control, child lock, cold climate, timer mode, hot indicator, lights, on-screen maintenance and troubleshooting notifications) | HTI 1 | \$ 389 | Y | Y | Y | Y | Y |
|-----------|---|-------|--------|---|---|---|---|---|

Wall Switch

| | | | | | | | | | |
|---------------|---|-------|----|-----|---|----|----|---|---|
| IFT-RC150-HTL | IntelliFire Touch white wireless wall switch (on/off, cold climate, battery strength indicator) | HTL 1 | \$ | 121 | Y | 14 | 14 | Y | Y |
| IFT-RC150-HNG | IntelliFire Touch white wireless wall switch (on/off, cold climate, battery strength indicator) | HNG 1 | \$ | 121 | Y | Y | Y | Y | Y |



IntelliFire app

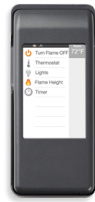

Touch Screen Remote



Wall Switch

Venting Notes

Requires 8" DVP pipe. Must have a 24" minimum vertical vent before attaching a 90° elbow to unit. See venting section.

Approved for use with PVLP-SLP and PVI-SLP-B with power vent wire harness (order separately). See venting section of manual.

Lanai 48 See-Through

Includes:

- Multi-colored LED lights
- Crystal glass media
- Glass wind guards
- Wall control with LED lights
- Gas flex connector
- 15' wire harness for wall control
- 48" x 17" viewing area
- 55,000 BTUs (NG & LP)
- UL/ULC listed



Required to Complete - Sold Separately: • Units are built NG. Conversion kit required for LP.

| | | Disc. Code | MSRP USD | 004 IA | 010 PA | 014 CA | 016 NC | EXP |
|---------------|---|------------|----------|--------|--------|--------|--------|-----|
| ODLANAIGST-48 | 48" Lanai outdoor linear fireplace with IntelliFire Ignition, See-through | HTI 3 | \$ 5,009 | Y | 14 | 14 | 14 | N |

Conversion Kit

Conversion Kit

| | | | | | | | | |
|----------------|-------------------------------|-------|--------|---|---|---|---|---|
| LPK-ODLANAIG48 | LP Conversion Kit - 48" Lanai | HTI 3 | \$ 129 | Y | Y | Y | Y | Y |
|----------------|-------------------------------|-------|--------|---|---|---|---|---|

Firescreens

Lanai Screen

| | | | | | | | | |
|----------------|-----------------------------------|-------|--------|---|---|---|---|---|
| ODLANAIG-48SCN | Framed Screen Barrier - 48" Lanai | HTI 3 | \$ 409 | Y | Y | Y | Y | Y |
|----------------|-----------------------------------|-------|--------|---|---|---|---|---|



Lanai Screen

Clean Face Kit

Lanai CF Kit

| | | | | | | | | |
|----------------|---------------------------------|-------|--------|---|----|----|----|---|
| ODLANAIG-48CFT | Clean Face Trim Kit - 48" Lanai | HTI 3 | \$ 279 | Y | 14 | 14 | 14 | Y |
|----------------|---------------------------------|-------|--------|---|----|----|----|---|

Gas Logs - Log Set Option

Log Accessories

| | | | | | | | | |
|------|-------------------|-------|--------|---|---|---|---|---|
| CDLS | Driftwood Log Set | HTI 1 | \$ 589 | Y | Y | Y | Y | Y |
|------|-------------------|-------|--------|---|---|---|---|---|

Media

Crushed Glass Media

| | | | | | | | | |
|-----------------|--|-------|--------|----|----|----|----|---|
| MEDIA-CLEAR-48 | Glass media, crystal (translucent white) | HTI 1 | \$ 259 | Y | Y | Y | Y | Y |
| MEDIA-AMBER-48 | Glass media, amber | HTI 1 | \$ 369 | Y | Y | Y | Y | Y |
| MEDIA-EBONY-48 | Glass media, ebony (black) | HTI 1 | \$ 369 | Y | Y | Y | Y | Y |
| MEDIA-RED-48 | Glass media, scarlet (red) | HTI 1 | \$ 369 | 14 | 21 | 14 | 14 | Y |
| MEDIA-COBALT-48 | Glass media, cobalt (blue) | HTI 1 | \$ 369 | Y | 21 | Y | 14 | Y |

MEDIA

| | | | | | | | | | |
|----------|-----------|-------|----|-----|---|---|---|---|---|
| STONEKIT | Stone Kit | HTI 1 | \$ | 149 | Y | Y | Y | Y | Y |
|----------|-----------|-------|----|-----|---|---|---|---|---|

Options & Accessories

Options & Accessories

| | | | | | | | | | |
|---------------|-----------------------|-------|----|-----|---|---|----|----|---|
| ODLANAIG-48DP | Drain Pan - 48" Lanai | HTI 3 | \$ | 229 | Y | Y | 14 | 14 | Y |
|---------------|-----------------------|-------|----|-----|---|---|----|----|---|

Venting Notes

No venting is required for this unit

Twilight Indoor/Outdoor See-Through Gas Fireplace

Includes:

- 38,000 Btu/Hour Input (NG)
- 36,000 Btu/Hour Input (LP)
- Gas flex connector
- Traditional refractory
- Junction box
- 7 ceramic fiber logs
- Manual gas shut-off valve
- Glowing embers
- Battery backup
- Exterior front
- IntelliFire Touch ignition system



Required to Complete - Sold Separately:

- 1 interior front
- Units are built NG. Conversion kit required for LP.
- Advanced Install Product training required before product ships

| | | Disc. Code | MSRP USD | 004 IA | 010 PA | 014 CA | 016 NC | EXP |
|--------------|---|------------|----------|--------|--------|--------|--------|-----|
| TWILIGHT-IFT | Twilight 36" Indoor/Outdoor See-Through Gas Fireplace with IntelliFire (NG) | HTI 3 | \$ 7,309 | Y | Y | Y | Y | N |

Fronts - Non-Operable (Required to Complete)

Twilight Firescreen

| | | | | | | | | |
|-----------|--------------------------|-------|--------|---|---|---|---|---|
| FS-TWI-BK | Firescreen front - Black | HTI 3 | \$ 459 | Y | Y | Y | Y | Y |
|-----------|--------------------------|-------|--------|---|---|---|---|---|

Twilight Modern Fronts

| | | | | | | | | |
|------------|--|-------|--------|----|----|----|----|---|
| TWI-MOD-BK | Contemporary front with built in, overlapping surround - Black | HTI 3 | \$ 749 | 14 | 14 | 14 | 14 | N |
|------------|--|-------|--------|----|----|----|----|---|



Twilight Firescreen



Twilight Modern Fronts

Conversion Kit

Conversion Kit

| | | | | | | | | |
|-------------|-------------------|-------|-------|----|----|----|----|---|
| NGK-MC-C | NG Conversion Kit | HTI 1 | \$ 99 | 14 | 14 | 14 | 14 | Y |
| LPK-TWI-IFT | LP Conversion Kit | HTI 3 | \$ 99 | Y | Y | Y | Y | Y |

Fans

Fan

| | | | | | | | | |
|----------|---|-------|--------|---|---|---|---|---|
| GFK-160T | Blower Assembly - Cannot install fan if ordering a modern front | HTI 1 | \$ 339 | Y | Y | Y | Y | Y |
|----------|---|-------|--------|---|---|---|---|---|

Control, remotes, wall switches

Battery Back Up

| | | | | | | | | |
|-------------|--|-------|--------|---|----|---|----|---|
| BATTERY-WSK | Battery backup wall switch kit for units with IFT control systems. Includes: On/Off Wall Switch, USB-C Port, Battery Backup, Cover Plate, 12' Wire Harness | HTI 1 | \$ 189 | Y | 14 | Y | 14 | Y |
|-------------|--|-------|--------|---|----|---|----|---|

| IntelliFire app | | | | | | | | |
|---|---|-------|--------|---|----|----|----|---|
| IFT-WFM | IntelliFire Wi-Fi Module that works with the IntelliFire iOS and Android app. Use to control all the features of your fireplace via a smart device. An RC400, RC450 or RC150 is required for thermostat control | HTI 1 | \$ 229 | Y | Y | Y | Y | Y |
| IntelliFire Touch Controls - Aux Module | | | | | | | | |
| IFT-ACM | IntelliFire Touch AUX Module. Must order if adding Fan, Lights or Power Vent and want to use the IFT-WFM. Do not need to order if using IFT-RC400 (includes IFT-ACM). | HTI 1 | \$ 98 | Y | Y | 14 | 14 | Y |
| Remote/Wall Switch/Wall Thermostat | | | | | | | | |
| IFT-RC150 | IntelliFire Touch white wireless wall switch (on/off, cold climate, battery strength | HTI 1 | \$ 121 | Y | 14 | 14 | Y | Y |
| Touch Screen Remote | | | | | | | | |
| IFT-RC400 | IntelliFire Touch black remote control, docking station and auxiliary control module (on/off, flame height, thermostat mode, fan control, child lock, cold climate, timer mode, hot indicator, lights, on-screen maintenance and troubleshooting notifications) | HTI 1 | \$ 389 | Y | Y | Y | Y | Y |
| Wall Switch | | | | | | | | |
| IFT-RC150-HTL | IntelliFire Touch white wireless wall switch (on/off, cold climate, battery strength indicator) | HTL 1 | \$ 121 | Y | 14 | 14 | Y | Y |
| IFT-RC150-HNG | IntelliFire Touch white wireless wall switch (on/off, cold climate, battery strength indicator) | HNG 1 | \$ 121 | Y | Y | Y | Y | Y |



Battery Back Up



IntelliFire app

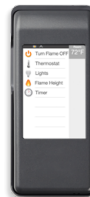

Touch Screen Remote



Wall Switch

Venting Notes
 No venting is required with this unit.

Twilight Modern Indoor/Outdoor See-Through Gas Fireplace

Includes:

- 38,000 Btu/Hour Input (NG)
- 36,000 Btu/Hour Input (LP)
- Black glass media
- Reflective black glass refractory
- Gas flex connector
- Manual gas shut-off valve
- Junction box
- Battery backup
- Exterior front
- IntelliFire Touch ignition system



Required to Complete - Sold Separately:

- 1 non-operable front required for interior
- Units are built NG. Conversion kit required for LP.
- Advanced Install Product training required before product ships

| | | Disc. Code | MSRP USD | 004 IA | 010 PA | 014 CA | 016 NC | EXP |
|-----------------|---|------------|----------|--------|--------|--------|--------|-----|
| TWILIGHT-MD-IFT | Twilight Modern 36" Indoor/Outdoor See-Through Gas Fireplace contemporary with Intellifire (NG) | HTI 3 | \$ 7,789 | 14 | 14 | Y | 14 | N |

Fronts - Non-Operable (Required to Complete)

Twilight Firescreen

| | | | | | | | | |
|-----------|--------------------------|-------|--------|---|---|---|---|---|
| FS-TWI-BK | Firescreen front - Black | HTI 3 | \$ 459 | Y | Y | Y | Y | Y |
|-----------|--------------------------|-------|--------|---|---|---|---|---|

Twilight Modern Fronts

| | | | | | | | | |
|------------|--|-------|--------|----|----|----|----|---|
| TWI-MOD-BK | Contemporary front with built in, overlapping surround - Black | HTI 3 | \$ 749 | 14 | 14 | 14 | 14 | N |
|------------|--|-------|--------|----|----|----|----|---|



Twilight Firescreen



Twilight Modern Fronts

Conversion Kit

Conversion Kit

| | | | | | | | | |
|-------------|-------------------|-------|-------|----|----|----|----|---|
| LPK-TWI-IFT | LP Conversion Kit | HTI 3 | \$ 99 | Y | Y | Y | Y | Y |
| NGK-MC-C | NG Conversion Kit | HTI 1 | \$ 99 | 14 | 14 | 14 | 14 | Y |

Media

Crushed Glass Media

| | | | | | | | | |
|-----------------|---|-------|--------|----|----|----|----|---|
| MEDIA-BLACK-20 | Glass media, Ebony (black) | HTI 1 | \$ 259 | 14 | 21 | 14 | 14 | N |
| MEDIA-AMBER-20 | Glass media, Amber | HTI 1 | \$ 269 | 14 | 21 | 14 | 14 | Y |
| MEDIA-CRYSTAL21 | Glass media, Crystal (translucent white) - 21 lbs | HTI 3 | \$ 289 | 14 | 21 | 14 | 14 | N |

Fans

Fan

| | | | | | | | | |
|----------|---|-------|--------|---|---|---|---|---|
| GFK-160T | Blower Assembly - Cannot install fan if ordering a modern front | HTI 1 | \$ 339 | Y | Y | Y | Y | Y |
|----------|---|-------|--------|---|---|---|---|---|

Control, remotes, wall switches

Battery Back Up

| | | | | | | | | |
|-------------|--|-------|--------|---|----|---|----|---|
| BATTERY-WSK | Battery backup wall switch kit for units with IFT control systems. Includes: On/Off Wall Switch, USB-C Port, Battery Backup, Cover Plate, 12' Wire Harness | HTI 1 | \$ 189 | Y | 14 | Y | 14 | Y |
|-------------|--|-------|--------|---|----|---|----|---|

IntelliFire app

| | | | | | | | | |
|---------|---|-------|--------|---|---|---|---|---|
| IFT-WFM | IntelliFire Wi-Fi Module that works with the IntelliFire iOS and Android app. Use to control all the features of your fireplace via a smart device. An RC400, RC450 or RC150 is required for thermostat control | HTI 1 | \$ 229 | Y | Y | Y | Y | Y |
|---------|---|-------|--------|---|---|---|---|---|

IntelliFire Touch Controls - Aux Module

| | | | | | | | | |
|---------|---|-------|-------|---|---|----|----|---|
| IFT-ACM | IntelliFire Touch AUX Module. Must order if adding Fan, Lights or Power Vent and want to use the IFT-WFM. Do not need to order if using IFT-RC400 (includes IFT-ACM). | HTI 1 | \$ 98 | Y | Y | 14 | 14 | Y |
|---------|---|-------|-------|---|---|----|----|---|

Remote/Wall Switch/Wall Thermostat

| | | | | | | | | |
|-----------|--|-------|--------|---|----|----|---|---|
| IFT-RC150 | IntelliFire Touch white wireless wall switch (on/off, cold climate, battery strength | HTI 1 | \$ 121 | Y | 14 | 14 | Y | Y |
|-----------|--|-------|--------|---|----|----|---|---|

Touch Screen Remote

| | | | | | | | | |
|-----------|---|-------|--------|---|---|---|---|---|
| IFT-RC400 | IntelliFire Touch black remote control, docking station and auxiliary control module (on/off, flame height, thermostat mode, fan control, child lock, cold climate, timer mode, hot indicator, lights, on-screen maintenance and troubleshooting notifications) | HTI 1 | \$ 389 | Y | Y | Y | Y | Y |
|-----------|---|-------|--------|---|---|---|---|---|

Wall Switch

| | | | | | | | | |
|---------------|---|-------|--------|---|----|----|---|---|
| IFT-RC150-HTL | IntelliFire Touch white wireless wall switch (on/off, cold climate, battery strength indicator) | HTL 1 | \$ 121 | Y | 14 | 14 | Y | Y |
| IFT-RC150-HNG | IntelliFire Touch white wireless wall switch (on/off, cold climate, battery strength indicator) | HNG 1 | \$ 121 | Y | Y | Y | Y | Y |



Battery Back Up



IntelliFire app

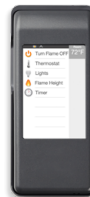

Touch Screen Remote



Wall Switch

Venting Notes

No venting is required with this unit.

| | | |
|--|--|---|
| <h1 style="margin: 0;">Hearth & Home Technologies</h1> | <h2 style="margin: 0;">Mantels - Flush Wood</h2> | <p>Stocked Item/Lead Time</p> <p>004=Mt. Pleasant RDC 010=Kutztown RDC 014=Sacramento RDC 016=Charlotte RDC</p> <p>EXP=Factory Expedite Program</p> |
|--|--|---|

Prices in USD

Page printed 3/31/2025, 8:22:26 AM CDT
* Please Contact Who You Purchase This Through for MSRP Pricing

Non-stock and custom product cannot be cancelled.
Customer is responsible for freight for orders made outside of assigned RDC facility.

Stained and Custom Flush Mantels, Cabinets and Shelves

For any stain order, an upcharge of \$300-320 (\$300 for 48”, \$310 for 59”, \$320 for 72”) for each shelf and \$420-\$440 (\$420 for A size, \$430 for B size and \$440 for C size) mantel is added to the MSRP. When ordering, the SKU to order requires a dash and appropriate color letter to the standard SKU number: Example: FMCYMP48-P, Crosby shelf in Provincial Brown. See below for proper SKU. Non-stock lead times apply.

-P = Provincial -NG = New Gray -WW = Whitewash -E = Ebony

Custom sizing available on request (for maple only). Please complete custom mantel order form and submit to your Customer Service representative.

To find this form in the new myHHT portal:

1. In the search bar at the top of the page, type “Custom Mantel Stain Order Form” and press enter.
2. Click the download icon on the left side of the search result and the file will begin downloading to your computer.

| Acadia A | | | | | | | |
|---|---------------------------------------|--------|-----|-----|-----|-----|-----|
|  | Disc. | MSRP | 004 | 010 | 014 | 016 | EXP |
| | Code | USD | IA | PA | CA | NC | |
| | HTI 1 | \$ 749 | 21 | Y | 21 | Y | N |
| AFAAMPA | Acadia Flush Mantel, Primed MDF | | 14 | 28 | 35 | 35 | N |
| AFAAAUA | Acadia Flush Mantel, Unfinished Maple | | 14 | 28 | 35 | 35 | N |

| Acadia B | | | | | | | |
|---|---------------------------------------|--------|-----|-----|-----|-----|-----|
|  | Disc. | MSRP | 004 | 010 | 014 | 016 | EXP |
| | Code | USD | IA | PA | CA | NC | |
| | HTI 1 | \$ 799 | Y | Y | 14 | Y | N |
| AFAAMPB | Acadia Flush Mantel, Primed MDF | | 14 | 28 | 35 | 35 | N |
| AFAAAUB | Acadia Flush Mantel, Unfinished Maple | | 14 | 28 | 35 | 35 | N |

Acadia C



| | Disc. Code | MSRP USD | 004 | 010 | 014 | 016 | EXP | | |
|---------|------------|---------------------------------------|-------|----------|-----|-----|-----|----|---|
| | | | IA | PA | CA | NC | | | |
| AFAAMPC | | Acadia Flush Mantel, Primed MDF | HTI 1 | \$ 829 | 21 | Y | 28 | Y | N |
| AFAAAUC | | Acadia Flush Mantel, Unfinished Maple | HTI 1 | \$ 1,269 | 14 | 28 | 35 | 35 | N |

Battlefield B



| | Disc. Code | MSRP USD | 004 | 010 | 014 | 016 | EXP | | |
|---------|------------|--|-------|----------|-----|-----|-----|----|---|
| | | | IA | PA | CA | NC | | | |
| AFBDMPB | | Battlefield Flush Mantel, Primed MDF | HTI 1 | \$ 1,519 | 21 | Y | 21 | 21 | N |
| AFBDKAB | | Battlefield Flush Mantel, Unfinished Distressed Knotty Alder | HTI 1 | \$ 2,269 | 14 | 28 | 35 | 35 | N |

Battlefield C



| | Disc. Code | MSRP USD | 004 | 010 | 014 | 016 | EXP | | |
|---------|------------|--|-------|----------|-----|-----|-----|----|---|
| | | | IA | PA | CA | NC | | | |
| AFBDMPC | | Battlefield Mantel, Primed MDF | HTI 1 | \$ 1,549 | 28 | Y | 14 | 21 | N |
| AFBDKAC | | Battlefield Flush Mantel, Unfinished Distressed Knotty Alder | HTI 1 | \$ 2,299 | 35 | 28 | 35 | 35 | N |

Corbels



| | Disc. Code | MSRP USD | 004 | 010 | 014 | 016 | EXP | | |
|----------|------------|-------------------------|-------|--------|-----|-----|-----|----|---|
| | | | IA | PA | CA | NC | | | |
| AFCORBMP | | Corbels (2), Primed MDF | HTI 1 | \$ 105 | 21 | Y | 28 | 21 | Y |

Kenwood A



| | Disc. Code | MSRP USD | 004 | 010 | 014 | 016 | EXP | | |
|---------|------------|---------------------------------------|-------|----------|-----|-----|-----|----|---|
| | | | IA | PA | CA | NC | | | |
| AFKDMPA | | Kenwood Flush Mantel Primed MDF | HTI 1 | \$ 749 | 21 | Y | 21 | Y | N |
| AFKDAUA | | Kenwood Flush Mantel Maple Unfinished | HTI 1 | \$ 1,199 | 14 | 28 | 35 | 35 | N |

Kenwood B



| | Disc. Code | MSRP USD | 004 | 010 | 014 | 016 | EXP |
|---------|---------------------------------------|----------------|-----|-----|-----|-----|-----|
| | | | IA | PA | CA | NC | |
| AFKDMPB | Kenwood Flush Mantel Primed MDF | HTI 1 \$ 799 | Y | Y | Y | Y | N |
| AFKDAUB | Kenwood Flush Mantel Maple Unfinished | HTI 1 \$ 1,229 | Y | Y | 35 | 35 | N |

Kenwood B60



| | Disc. Code | MSRP USD | 004 | 010 | 014 | 016 | EXP |
|-----------|---|--------------|-----|-----|-----|-----|-----|
| | | | IA | PA | CA | NC | |
| AFKDMPB60 | Kenwood Flush Mantel, Primed MDF; 60" outside width | HTI 1 \$ 799 | Y | Y | 21 | Y | N |

Kenwood C



| | Disc. Code | MSRP USD | 004 | 010 | 014 | 016 | EXP |
|---------|---------------------------------------|----------------|-----|-----|-----|-----|-----|
| | | | IA | PA | CA | NC | |
| AFKDMPC | Kenwood Flush Mantel Primed MDF | HTI 1 \$ 829 | Y | Y | 14 | Y | N |
| AFKDAUC | Kenwood Flush Mantel Maple Unfinished | HTI 1 \$ 1,269 | 14 | 28 | 35 | 35 | N |

Laurel B



| | Disc. Code | MSRP USD | 004 | 010 | 014 | 016 | EXP |
|--------------|---|----------------|-----|-----|-----|-----|-----|
| | | | IA | PA | CA | NC | |
| AFLLMPAUB | LAUREL MANTEL MDF/MAPLE | HTI 1 \$ 1,959 | 35 | Y | 35 | Y | N |
| AFLLMPAUB-NG | Laurel Mantel, Primed MDF & Maple top with New Gray Stain | HTI 1 \$ 2,269 | 14 | 28 | 35 | 35 | N |
| AFLLMPAUB-P | Laurel Mantel, Primed MDF & Maple top with Provincial Stain | HTI 1 \$ 2,269 | 35 | Y | 35 | 35 | N |
| AFLLMPAUB-WW | Laurel Mantel, Primed MDF & Maple top with Whitewash Stain | HTI 1 \$ 2,269 | 14 | 28 | 35 | 35 | N |
| AFLLMPAUB-E | Laurel Mantel, Primed MDF & Maple top with Ebony Stain | HTI 1 \$ 2,269 | 14 | 28 | 35 | 35 | N |

Laurel C



| | | Disc. Code | MSRP USD | 004 IA | 010 PA | 014 CA | 016 NC | EXP |
|--------------|---|---------------|-------------|-----------|-----------|-----------|-----------|-----|
| AFLLMPAUC | LAUREL MANTEL MDF/MAPLE | HTI 1 | \$ 1,989 | 35 | 28 | 35 | 35 | N |
| AFLLMPAUC-P | Laurel Mantel, Primed MDF & Maple top with Provincial Stain | HTI 1 | \$ 2,299 | 14 | 28 | 35 | 35 | N |
| AFLLMPAUC-E | Laurel Mantel, Primed MDF & Maple top with Ebony Stain | HTI 1 | \$ 2,299 | 14 | 28 | 35 | 35 | N |
| AFLLMPAUC-NG | Laurel Mantel, Primed MDF & Maple top with New Gray Stain | HTI 1 | \$ 2,299 | 14 | 28 | 35 | 35 | N |
| AFLLMPAUC-WW | Laurel Mantel, Primed MDF & Maple top with Whitewash Stain | HTI 1 | \$ 2,299 | 14 | 28 | 35 | 35 | N |

Malone B



| | | Disc. Code | MSRP USD | 004 IA | 010 PA | 014 CA | 016 NC | EXP |
|---------|---------------------------|---------------|-------------|-----------|-----------|-----------|-----------|-----|
| AFMEMPB | Malone Mantel, Primed MDF | HTI 1 | \$ 1,519 | 21 | Y | 21 | Y | N |

Malone C



| | | Disc. Code | MSRP USD | 004 IA | 010 PA | 014 CA | 016 NC | EXP |
|---------|---------------------------|---------------|-------------|-----------|-----------|-----------|-----------|-----|
| AFMEMPC | Malone Mantel, Primed MDF | HTI 1 | \$ 1,549 | 21 | Y | 21 | 14 | N |

Merritt A



| | | Disc. Code | MSRP USD | 004 IA | 010 PA | 014 CA | 016 NC | EXP |
|---------|----------------------------|---------------|-------------|-----------|-----------|-----------|-----------|-----|
| AFMTMPA | Merritt Mantel, Primed MDF | HTI 1 | \$ 749 | 21 | Y | 21 | Y | N |

Merritt B



| | | Disc. Code | MSRP USD | 004 IA | 010 PA | 014 CA | 016 NC | EXP |
|---------|----------------------------|---------------|-------------|-----------|-----------|-----------|-----------|-----|
| AFMTMPB | Merritt Mantel, Primed MDF | HTI 1 | \$ 799 | 21 | Y | 21 | Y | N |

Merritt C



| | Disc. Code | MSRP USD | 004 | 010 | 014 | 016 | EXP |
|---------|----------------------------|--------------|-----|-----|-----|-----|-----|
| | | | IA | PA | CA | NC | |
| AFMTMPC | Merritt Mantel, Primed MDF | HTI 1 \$ 829 | 21 | Y | 21 | 21 | N |

Richland A



| | Disc. Code | MSRP USD | 004 | 010 | 014 | 016 | EXP |
|---------|-----------------------------------|--------------|-----|-----|-----|-----|-----|
| | | | IA | PA | CA | NC | |
| AFRDMPA | Richland Flush Mantel, Primed MDF | HTI 1 \$ 579 | 21 | Y | 14 | Y | N |

Richland B



| | Disc. Code | MSRP USD | 004 | 010 | 014 | 016 | EXP |
|---------|-----------------------------------|--------------|-----|-----|-----|-----|-----|
| | | | IA | PA | CA | NC | |
| AFRDMPB | Richland Flush Mantel, Primed MDF | HTI 1 \$ 639 | Y | Y | 14 | Y | N |

Richland C



| | Disc. Code | MSRP USD | 004 | 010 | 014 | 016 | EXP |
|---------|-----------------------------------|--------------|-----|-----|-----|-----|-----|
| | | | IA | PA | CA | NC | |
| AFRDMPA | Richland Flush Mantel, Primed MDF | HTI 1 \$ 669 | 21 | Y | 14 | Y | N |

Richland RS



| | Disc. Code | MSRP USD | 004 | 010 | 014 | 016 | EXP |
|-----------|--|--------------|-----|-----|-----|-----|-----|
| | | | IA | PA | CA | NC | |
| AFRDMPARS | Richland Flush Mantel, Primed MDF, Reduced Shelf width | HTI 1 \$ 559 | 21 | Y | 21 | Y | N |
| AFRDMPBRS | RICHLAND MANTEL RS | HTI 1 \$ 649 | 21 | Y | 21 | Y | N |

Roxborough A



| | Disc. Code | MSRP USD | 004 | 010 | 014 | 016 | EXP |
|---------|------------|----------|-----|-----|-----|-----|-----|
| | | | IA | PA | CA | NC | |
| AFRHMPA | HTI 1 | \$ 749 | 14 | Y | 21 | Y | N |

Roxborough B



| | Disc. Code | MSRP USD | 004 | 010 | 014 | 016 | EXP |
|---------|------------|----------|-----|-----|-----|-----|-----|
| | | | IA | PA | CA | NC | |
| AFRHMPB | HTI 1 | \$ 799 | Y | Y | 14 | Y | N |

Roxborough C



| | Disc. Code | MSRP USD | 004 | 010 | 014 | 016 | EXP |
|---------|------------|----------|-----|-----|-----|-----|-----|
| | | | IA | PA | CA | NC | |
| AFRHMPC | HTI 1 | \$ 829 | 21 | Y | 21 | Y | N |

Walker B



| | Disc. Code | MSRP USD | 004 | 010 | 014 | 016 | EXP |
|---------|------------|----------|-----|-----|-----|-----|-----|
| | | | IA | PA | CA | NC | |
| AFWKMPB | HTI 1 | \$ 1,519 | 14 | Y | 14 | Y | N |

Walker C



| | Disc. Code | MSRP USD | 004 | 010 | 014 | 016 | EXP |
|---------|------------|----------|-----|-----|-----|-----|-----|
| | | | IA | PA | CA | NC | |
| AFWKMPC | HTI 1 | \$ 1,549 | 21 | Y | 21 | 21 | N |

Wescott A



| | Disc. Code | MSRP USD | 004 | 010 | 014 | 016 | EXP |
|---------|------------|----------|-----|-----|-----|-----|-----|
| | | | IA | PA | CA | NC | |
| AFWTMPA | HTI 1 | \$ 579 | Y | Y | 14 | Y | N |

Wescott B



| | Disc. Code | MSRP USD | 004 | 010 | 014 | 016 | EXP |
|---------|------------|----------|-----|-----|-----|-----|-----|
| | | | IA | PA | CA | NC | |
| AFWTMPB | HTI 1 | \$ 639 | Y | Y | 21 | Y | N |

Wescott C



| | Disc. Code | MSRP USD | 004 | 010 | 014 | 016 | EXP |
|---------|------------|----------|-----|-----|-----|-----|-----|
| | | | IA | PA | CA | NC | |
| AFWTMPC | HTI 1 | \$ 669 | 21 | Y | 21 | Y | N |

Zimmer A



| | Disc. Code | MSRP USD | 004 | 010 | 014 | 016 | EXP |
|---------|------------|----------|-----|-----|-----|-----|-----|
| | | | IA | PA | CA | NC | |
| AFZRMPA | HTI 1 | \$ 749 | 21 | Y | 21 | 21 | N |

Zimmer B



| | Disc. Code | MSRP USD | 004 | 010 | 014 | 016 | EXP |
|---------|------------|----------|-----|-----|-----|-----|-----|
| | | | IA | PA | CA | NC | |
| AFZRMPB | HTI 1 | \$ 799 | 21 | Y | 21 | Y | N |

Zimmer C



| | | Disc. Code | MSRP USD | 004 IA | 010 PA | 014 CA | 016 NC | EXP |
|---------|---------------------------|---------------|-------------|-----------|-----------|-----------|-----------|-----|
| AFZRMPC | Zimmer Mantel, Primed MDF | HTI 1 | \$ 829 | 21 | Y | 21 | 21 | N |

| | | |
|---|------------------------------------|--|
| <h1>Hearth & Home Technologies</h1> | <h2>Optional Wood Mantel Base</h2> | <p>Stocked Item/Lead Time</p> <p>004=Mt. Pleasant RDC 010=Kutztown RDC 014=Sacramento RDC 016=Charlotte RDC</p> <p>EXP=Factory Expedite Program</p> |
|---|------------------------------------|--|

Prices in USD

Page printed 3/31/2025, 8:22:26 AM CDT
 * Please Contact Who You Purchase This Through for MSRP Pricing

Non-stock and custom product cannot be cancelled.
 Customer is responsible for freight for orders made outside of assigned RDC facility.

Kenwood A Flush Mantel Base

| | | Disc. Code | MSRP USD | 004 IA | 010 PA | 014 CA | 016 NC | EXP |
|---|---------|--|--------------|--------|--------|--------|--------|-----|
|  | HTKDMPA | Kenwood - Optional Base Primed MDF | HTI 1 \$ 419 | 21 | Y | 21 | Y | N |
| | HTKDAUA | Kenwood - Optional Base Maple Unfinished | HTI 1 \$ 809 | 14 | 28 | 35 | 35 | N |

Kenwood B Flush Mantel Optional Base

| | | Disc. Code | MSRP USD | 004 IA | 010 PA | 014 CA | 016 NC | EXP |
|---|---------|--|--------------|--------|--------|--------|--------|-----|
|  | HTKDMPB | Kenwood - Optional Base Primed MDF | HTI 1 \$ 449 | 21 | Y | 21 | 21 | N |
| | HTKDAUB | Kenwood - Optional Base Maple Unfinished | HTI 1 \$ 829 | 14 | 28 | 35 | 35 | N |

Kenwood C Flush Mantel Optional Base

| | | Disc. Code | MSRP USD | 004 IA | 010 PA | 014 CA | 016 NC | EXP |
|---|---------|--|--------------|--------|--------|--------|--------|-----|
|  | HTKDMPC | Kenwood - Optional Base Primed MDF | HTI 1 \$ 479 | 28 | 28 | 35 | 35 | N |
| | HTKDAUC | Kenwood - Optional Base Maple Unfinished | HTI 1 \$ 859 | 14 | 28 | 21 | 35 | N |

| | | |
|---|---|---|
| <h1>Hearth & Home Technologies</h1> | <h2>Samples - Wood Mantel Shoulder</h2> | <p>Stocked Item/Lead Time</p> <p>004=Mt. Pleasant RDC 010=Kutztown RDC 014=Sacramento RDC 016=Charlotte RDC</p> <p>EXP=Factory Expedite Program</p> |
|---|---|---|

Prices in USD

Page printed 3/31/2025, 8:22:26 AM CDT
* Please Contact Who You Purchase This Through for MSRP Pricing

Non-stock and custom product cannot be cancelled.
Customer is responsible for freight for orders made outside of assigned RDC facility.

Acadia Mantel Sample



| Disc. Code | MSRP USD | HTI | 004 | 010 | 014 | 016 | EXP | | |
|------------|----------------------|----------|-----|-----|-----|-----|-----|----|---|
| | | | IA | PA | CA | NC | | | |
| AFAAMPY | ACADIA MANTEL SAMPLE | HTI null | \$ | 111 | 21 | Y | 21 | 21 | N |

Battlefield Mantel Sample



| Disc. Code | MSRP USD | HTI | 004 | 010 | 014 | 016 | EXP | | |
|------------|---------------------------|----------|-----|-----|-----|-----|-----|----|---|
| | | | IA | PA | CA | NC | | | |
| AFBDMPY | BATTLEFIELD MANTEL SAMPLE | HTI null | \$ | 111 | 21 | Y | 28 | 21 | N |

Kenwood Wood Mantel Sample - Primed MDF



| Disc. Code | MSRP USD | HTI | 004 | 010 | 014 | 016 | EXP | | |
|------------|---|----------|-----|-----|-----|-----|-----|----|---|
| | | | IA | PA | CA | NC | | | |
| AFKDMPY | Kenwood mantel shoulder sample - Primed MDF | HTI null | \$ | 111 | 21 | Y | 21 | 21 | Y |

Laurel Mantel Sample



| Disc. Code | MSRP USD | HTI | 004 | 010 | 014 | 016 | EXP | | |
|--------------|--|-------|-----|-----|-----|-----|-----|----|---|
| | | | IA | PA | CA | NC | | | |
| AFLLMPAUY-WW | Laurel Mantel Sample, Primed MDF & Maple top with Whitewash Stain | HTI 1 | \$ | 249 | 14 | 28 | 35 | 35 | N |
| AFLLMPAUY-E | Laurel Mantel Sample, Primed MDF & Maple top with Ebony Stain | HTI 1 | \$ | 249 | 14 | 28 | 35 | 35 | N |
| AFLLMPAUY-NG | Laurel Mantel Sample, Primed MDF & Maple top with New Gray Stain | HTI 1 | \$ | 249 | 14 | 28 | 35 | 35 | N |
| AFLLMPAUY-P | Laurel Mantel Sample, Primed MDF & Maple top with Provincial Stain | HTI 1 | \$ | 249 | 14 | 28 | 35 | 35 | N |

Malone Mantel Sample



| | Disc. Code | MSRP USD | 004 | 010 | 014 | 016 | EXP | | | | |
|---------|------------|----------------------------------|-------|-----|-----|-----|-----|----|---|----|---|
| | | | IA | PA | CA | NC | | | | | |
| AFMEMPY | | Malone Mantel Sample, Primed MDF | HTI 1 | \$ | 111 | 21 | Y | 21 | Y | 21 | Y |

Merritt Mantel Sample

| | Disc. Code | MSRP USD | 004 | 010 | 014 | 016 | EXP | | | | |
|---------|------------|-----------------------------------|-------|-----|-----|-----|-----|----|---|----|---|
| | | | IA | PA | CA | NC | | | | | |
| AFMTMPY | | Merritt Mantel Sample, Primed MDF | HTI 1 | \$ | 111 | 21 | Y | 21 | Y | 21 | Y |

Richland Mantel Sample



| | Disc. Code | MSRP USD | 004 | 010 | 014 | 016 | EXP | | | | |
|---------|------------|------------------------|----------|-----|-----|-----|-----|----|---|----|---|
| | | | IA | PA | CA | NC | | | | | |
| AFRDMPY | | RICHLAND MANTEL SAMPLE | HTI null | \$ | 111 | 21 | Y | 21 | Y | 21 | N |

Roxborough Mantel Sample



| | Disc. Code | MSRP USD | 004 | 010 | 014 | 016 | EXP | | | | |
|---------|------------|--------------------------|----------|-----|-----|-----|-----|----|---|----|---|
| | | | IA | PA | CA | NC | | | | | |
| AFRHMPY | | ROXBOROUGH MANTEL SAMPLE | HTI null | \$ | 111 | 21 | Y | 21 | Y | 21 | N |

Walker Mantel Sample



| | Disc. Code | MSRP USD | 004 | 010 | 014 | 016 | EXP | | | | |
|---------|------------|----------------------------------|-------|-----|-----|-----|-----|----|---|----|---|
| | | | IA | PA | CA | NC | | | | | |
| AFWKMPY | | Walker Mantel Sample, Primed MDF | HTI 1 | \$ | 111 | 21 | Y | 21 | Y | 21 | Y |

Wescott Mantel Sample



| | Disc. Code | MSRP USD | 004 | 010 | 014 | 016 | EXP | | | | |
|---------|------------|-----------------------|----------|-----|-----|-----|-----|----|---|----|---|
| | | | IA | PA | CA | NC | | | | | |
| AFWTMPY | | WESCOTT MANTEL SAMPLE | HTI null | \$ | 111 | 21 | Y | 21 | Y | 21 | N |

Zimmer Mantel Sample

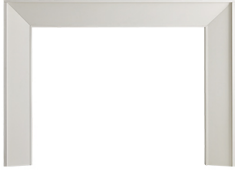

| | | Disc. Code | MSRP USD | 004 IA | 010 PA | 014 CA | 016 NC | EXP |
|---------|----------------------------------|---------------|-------------|-----------|-----------|-----------|-----------|-----|
| AFZRMPY | Zimmer Mantel Sample, Primed MDF | HTI 1 | \$ 111 | 21 | Y | 21 | 21 | Y |

| | | |
|---|---|---|
| <h1>Hearth & Home Technologies</h1> | <h2>Samples - Non-Combustible Shelf Shoulder</h2> | <p>Stocked Item/Lead Time</p> <p>004=Mt. Pleasant RDC 010=Kutztown RDC 014=Sacramento RDC 016=Charlotte RDC</p> <p>EXP=Factory Expedite Program</p> |
|---|---|---|

Page printed 3/31/2025, 8:22:26 AM CDT
* Please Contact Who You Purchase This Through for MSRP Pricing

Prices in USD
Non-stock and custom product cannot be cancelled.
Customer is responsible for freight for orders made outside of assigned RDC facility.

Non-Combustible Cove Gray 18"



| | | Disc. Code | MSRP USD | 004 IA | 010 PA | 014 CA | 016 NC | EXP |
|--------|--|------------|----------|--------|--------|--------|--------|-----|
| FMCNCY | Non-Combustible Cove Gray 18" Shelf Sample | HTI 1 | \$ 299 | 21 | Y | 14 | 21 | Y |

Non-Combustible Midnight Mist 18"



| | | Disc. Code | MSRP USD | 004 IA | 010 PA | 014 CA | 016 NC | EXP |
|--------|--|------------|----------|--------|--------|--------|--------|-----|
| FMMNCY | Non-Combustible 18" Midnight Mist Shelf Sample | HTI 1 | \$ 299 | 14 | Y | 14 | 21 | Y |

Non-Combustible Tavern Brown 18"



| | | Disc. Code | MSRP USD | 004 IA | 010 PA | 014 CA | 016 NC | EXP |
|---------|---|------------|----------|--------|--------|--------|--------|-----|
| FMTBNCY | Non-Combustible 18" Tavern Brown Shelf Sample | HTI 1 | \$ 299 | 21 | Y | 14 | 21 | Y |

Non-Combustible Washed Cedar 18"



| | | Disc. Code | MSRP USD | 004 IA | 010 PA | 014 CA | 016 NC | EXP |
|---------|---|------------|----------|--------|--------|--------|--------|-----|
| FMWCNCY | Non-Combustible 18" Washed Cedar Shelf Sample | HTI 1 | \$ 299 | 14 | Y | 21 | 14 | Y |

Non-Combustible Weathered Barnwood 18"



| | Disc. Code | MSRP USD | 004 | 010 | 014 | 016 | EXP |
|--|---------------|-------------|-----|-----|-----|-----|-----|
| | | | IA | PA | CA | NC | |
| FMWBNCY Non-Combustible 18" Weathered Barnwood Shelf Sample | HTI 1 | \$ 299 | 14 | Y | 21 | 14 | Y |

Non-Combustible White 18"



| | Disc. Code | MSRP USD | 004 | 010 | 014 | 016 | EXP |
|---|---------------|-------------|-----|-----|-----|-----|-----|
| | | | IA | PA | CA | NC | |
| FMWHNCY Non-Combustible 18" White Shelf Sample | HTI 1 | \$ 299 | 14 | Y | 21 | 14 | Y |

| | | |
|---|-------------------------------|---|
| <h1>Hearth & Home Technologies</h1> | <h2>Mantels - Shelf Wood</h2> | Stocked Item/Lead Time 004=Mt. Pleasant RDC 010=Kutztown RDC 014=Sacramento RDC 016=Charlotte RDC EXP=Factory Expedite Program |
|---|-------------------------------|---|

Page printed 3/31/2025, 8:22:26 AM CDT
 * Please Contact Who You Purchase This Through for MSRP Pricing

Prices in USD

Non-stock and custom product cannot be cancelled.
 Customer is responsible for freight for orders made outside of assigned RDC facility.

Stained and Custom Flush Mantels, Cabinets and Shelves

For any stain order, an upcharge of \$300-320 (\$300 for 48", \$310 for 59", \$320 for 72") for each shelf and \$420-\$440 (\$420 for A size, \$430 for B size and \$440 for C size) mantel is added to the MSRP. When ordering, the SKU to order requires a dash and appropriate color letter to the standard SKU number: Example: FMCYMP48-P, Crosby shelf in Provincial Brown. See below for proper SKU. Non-stock lead times apply.

-P = Provincial -NG = New Gray -WW = Whitewash -E = Ebony

Custom sizing available on request (for maple only). Please complete custom mantel order form and submit to your Customer Service representative.

To find this form in the new myHHT portal:

1. In the search bar at the top of the page, type "Custom Mantel Stain Order Form" and press enter.
2. Click the download icon on the left side of the search result and the file will begin downloading to your computer.

| Baxter 48" | | Disc. | MSRP | 004 | 010 | 014 | 016 | EXP |
|---|----------|------------------------------------|--------------|-----|-----|-----|-----|-----|
| | | Code | USD | IA | PA | CA | NC | |
|  | FMBRMP48 | 48" Baxter Shelf, Primed MDF | HTI 1 \$ 539 | 21 | Y | 14 | 21 | N |
| | FMBRAU48 | 48" Baxter Shelf, Unfinished Maple | HTI 1 \$ 939 | 14 | 28 | 35 | 35 | N |

| Baxter 59" | | Disc. | MSRP | 004 | 010 | 014 | 016 | EXP |
|---|----------|------------------------------------|--------------|-----|-----|-----|-----|-----|
| | | Code | USD | IA | PA | CA | NC | |
|  | FMBRMP59 | 59" Baxter Shelf, Primed MDF | HTI 1 \$ 569 | 21 | Y | 14 | 21 | N |
| | FMBRAU59 | 59" Baxter Shelf, Unfinished Maple | HTI 1 \$ 989 | 35 | Y | 35 | 35 | N |

Baxter 72"

| | | | Disc. Code | MSRP USD | 004 | 010 | 014 | 016 | EXP |
|---|-------------|------------------------------------|---------------|-------------|-----|-----|-----|-----|-----|
| | | | | | IA | PA | CA | NC | |
|  | FMBRMP72 | 72" Baxter Shelf, Primed MDF | HTI 1 | \$ 649 | 21 | Y | 21 | 21 | N |
| | FMBRAU72 | 72" Baxter Shelf, Unfinished Maple | HTI 1 | \$ 1,029 | 35 | Y | 35 | 35 | N |
| | FMBRAU72-NG | 72* BAXTER M - NEW GRAY | HTI 1 | \$ 1,359 | 14 | 28 | 35 | 35 | N |

Crosby 48"

| | | | Disc. Code | MSRP USD | 004 | 010 | 014 | 016 | EXP |
|---|----------|-----------------------------|---------------|-------------|-----|-----|-----|-----|-----|
| | | | | | IA | PA | CA | NC | |
|  | FMCYMP48 | 48* CROSBY SHELF MDF | HTI 1 | \$ 539 | 21 | Y | 21 | 21 | N |
| | FMCYAU48 | Crosby 48, Unfinished Maple | HTI 1 | \$ 939 | 14 | 28 | 35 | 35 | N |

Crosby 59"

| | | | Disc. Code | MSRP USD | 004 | 010 | 014 | 016 | EXP |
|---|----------|------------------------------------|---------------|-------------|-----|-----|-----|-----|-----|
| | | | | | IA | PA | CA | NC | |
|  | FMCYMP59 | 59" Crosby Shelf, Primed MDF | HTI 1 | \$ 569 | 21 | Y | 21 | 21 | N |
| | FMCYAU59 | 59" Crosby Shelf, Unfinished Maple | HTI 1 | \$ 989 | 35 | Y | 35 | 14 | N |

Crosby 72"

| | | | Disc. Code | MSRP USD | 004 | 010 | 014 | 016 | EXP |
|---|----------|------------------------------------|---------------|-------------|-----|-----|-----|-----|-----|
| | | | | | IA | PA | CA | NC | |
|  | FMCYMP72 | 72" Crosby Shelf, Primed MDF | HTI 1 | \$ 649 | 21 | Y | 21 | 21 | N |
| | FMCYAU72 | 72" Crosby Shelf, Unfinished Maple | HTI 1 | \$ 1,029 | 35 | Y | 35 | 35 | N |

Fillmore 48"

| | | | Disc. Code | MSRP USD | 004 | 010 | 014 | 016 | EXP |
|---|----------|-------------------------------|---------------|-------------|-----|-----|-----|-----|-----|
| | | | | | IA | PA | CA | NC | |
|  | FMFEMP48 | 48" Fillmore Primed MDF | HTI 1 | \$ 379 | 14 | Y | 14 | 21 | N |
| | FMFEAU48 | 48" Fillmore Unfinished Maple | HTI 1 | \$ 579 | 14 | 28 | 35 | 35 | N |

Fillmore 59"

| | | | Disc. Code | MSRP USD | 004 | 010 | 014 | 016 | EXP |
|---|----------|-------------------------------|---------------|-------------|-----|-----|-----|-----|-----|
| | | | | | IA | PA | CA | NC | |
|  | FMFEMP59 | 59" Fillmore Primed MDF | HTI 1 | \$ 419 | 21 | Y | 21 | Y | N |
| | FMFEAU59 | 59" Fillmore Unfinished Maple | HTI 1 | \$ 649 | 21 | Y | 35 | 21 | N |

Fillmore 72"

| | | | Disc. Code | MSRP USD | 004 | 010 | 014 | 016 | EXP |
|---|----------|-------------------------------|---------------|-------------|-----|-----|-----|-----|-----|
| | | | | | IA | PA | CA | NC | |
|  | FMFEMP72 | 72" Fillmore Primed MDF | HTI 1 | \$ 459 | 21 | Y | 21 | 21 | N |
| | FMFEAU72 | 72" Fillmore Unfinished Maple | HTI 1 | \$ 679 | 14 | 28 | 35 | 35 | N |

Ozark 48"

| | | | Disc. Code | MSRP USD | 004 | 010 | 014 | 016 | EXP |
|---|----------|--|---------------|-------------|-----|-----|-----|-----|-----|
| | | | | | IA | PA | CA | NC | |
|  | FMOKMP48 | 48" Ozark Primed MDF | HTI 1 | \$ 719 | 21 | Y | 21 | 21 | N |
| | FMOKAU48 | 48" Ozark Unfinished Maple | HTI 1 | \$ 1,119 | 21 | Y | 35 | 21 | N |
| | FMOKKA48 | 48" Ozark Unfinished Distressed Knotty Alder | HTI 1 | \$ 1,219 | 14 | 28 | 35 | 35 | N |

Ozark 59"

| | | | Disc. Code | MSRP USD | 004 | 010 | 014 | 016 | EXP |
|---|----------|--|---------------|-------------|-----|-----|-----|-----|-----|
| | | | | | IA | PA | CA | NC | |
|  | FMOKMP59 | 59" Ozark Primed MDF | HTI 1 | \$ 769 | Y | Y | 14 | Y | N |
| | FMOKAU59 | 59" Ozark Unfinished Maple | HTI 1 | \$ 1,189 | Y | Y | 35 | Y | N |
| | FMOKKA59 | 59" Ozark Unfinished Distressed Knotty Alder | HTI 1 | \$ 1,259 | 35 | Y | 35 | Y | N |

Ozark 72"

| | | | Disc. Code | MSRP USD | 004 | 010 | 014 | 016 | EXP |
|---|----------|--|---------------|-------------|-----|-----|-----|-----|-----|
| | | | | | IA | PA | CA | NC | |
|  | FMOKMP72 | 72" Ozark Primed MDF | HTI 1 | \$ 819 | 21 | Y | 14 | Y | N |
| | FMOKAU72 | 72" Ozark Unfinished Maple | HTI 1 | \$ 1,219 | Y | Y | 35 | 21 | N |
| | FMOKKA72 | 72" Ozark Unfinished Distressed Knotty Alder | HTI 1 | \$ 1,289 | Y | Y | 35 | Y | N |

| | | |
|---|--------------------------------|---|
| <h1>Hearth & Home Technologies</h1> | <h2>Shelf Non-Combustible</h2> | <p>Stocked Item/Lead Time</p> <p>004=Mt. Pleasant RDC 010=Kutztown RDC 014=Sacramento RDC 016=Charlotte RDC</p> <p>EXP=Factory Expedite Program</p> |
|---|--------------------------------|---|

Page printed 3/31/2025, 8:22:26 AM CDT
* Please Contact Who You Purchase This Through for MSRP Pricing

Prices in USD

Non-stock and custom product cannot be cancelled.
Customer is responsible for freight for orders made outside of assigned RDC facility.

Non-Combustible Cove Gray 60"

| | | | | | | | | |
|---|---|---------------|-------------|-----------|-----------|-----------|-----------|----------|
|  | | Disc. Code | MSRP USD | 004 IA | 010 PA | 014 CA | 016 NC | EXP N |
| | <p>FMSGNC-60 60" Non-Combustible Cove Gray</p> | HTI 1 | \$ 1,239 | 14 | Y | 14 | 21 | N |

Non-Combustible Cove Gray 72"

| | | | | | | | | |
|---|---|---------------|-------------|-----------|-----------|-----------|-----------|----------|
|  | | Disc. Code | MSRP USD | 004 IA | 010 PA | 014 CA | 016 NC | EXP N |
| | <p>FMSGNC-72 72" Non-combustible Cove Gray</p> | HTI 1 | \$ 1,389 | 14 | Y | 14 | 14 | N |

Non-Combustible Midnight Mist 60"

| | | | | | | | | |
|---|---|---------------|-------------|-----------|-----------|-----------|-----------|----------|
|  | | Disc. Code | MSRP USD | 004 IA | 010 PA | 014 CA | 016 NC | EXP N |
| | <p>FMMMNC-60 60" Non-combustible Midnight Mist</p> | HTI 1 | \$ 1,239 | 21 | Y | 21 | 21 | N |

Non-Combustible Midnight Mist 72"

| | | | | | | | | |
|---|---|---------------|-------------|-----------|-----------|-----------|-----------|----------|
|  | | Disc. Code | MSRP USD | 004 IA | 010 PA | 014 CA | 016 NC | EXP N |
| | <p>FMMMNC-72 72" Non-combustible Midnight Mist</p> | HTI 1 | \$ 1,389 | 21 | Y | 21 | 14 | N |

Non-Combustible Tavern Brown 60"



| | Disc. Code | MSRP USD | 004 | 010 | 014 | 016 | EXP |
|-----------|------------|----------|-----|-----|-----|-----|-----|
| | | | IA | PA | CA | NC | |
| FMTBNC-60 | HTI 1 | \$ 1,349 | 14 | Y | 14 | 21 | N |

Non-Combustible Tavern Brown 72"



| | Disc. Code | MSRP USD | 004 | 010 | 014 | 016 | EXP |
|-----------|------------|----------|-----|-----|-----|-----|-----|
| | | | IA | PA | CA | NC | |
| FMTBNC-72 | HTI 1 | \$ 1,499 | 21 | Y | 14 | 21 | N |

Non-Combustible Washed Cedar 60"



| | Disc. Code | MSRP USD | 004 | 010 | 014 | 016 | EXP |
|-----------|------------|----------|-----|-----|-----|-----|-----|
| | | | IA | PA | CA | NC | |
| FMWCNC-60 | HTI 1 | \$ 1,349 | 21 | Y | 21 | 21 | N |

Non-Combustible Washed Cedar 72"



| | Disc. Code | MSRP USD | 004 | 010 | 014 | 016 | EXP |
|-----------|------------|----------|-----|-----|-----|-----|-----|
| | | | IA | PA | CA | NC | |
| FMWCNC-72 | HTI 1 | \$ 1,499 | 14 | Y | 14 | 21 | N |

Non-Combustible Weathered Barnwood 60"



| | Disc. Code | MSRP USD | 004 | 010 | 014 | 016 | EXP |
|-----------|------------|----------|-----|-----|-----|-----|-----|
| | | | IA | PA | CA | NC | |
| FMWBNC-60 | HTI 1 | \$ 1,349 | 21 | Y | 14 | 21 | N |

Non-Combustible Weathered Barnwood 72"



| | | Disc. Code | MSRP USD | 004 IA | 010 PA | 014 CA | 016 NC | EXP |
|-----------|------------------------------|---------------|-------------|-----------|-----------|-----------|-----------|-----|
| FMWBNC-72 | 72" Non-Combustible Barnwood | HTI 1 | \$ 1,499 | 21 | Y | 21 | 21 | N |

Non-Combustible White 60"



| | | Disc. Code | MSRP USD | 004 IA | 010 PA | 014 CA | 016 NC | EXP |
|-----------|---------------------------|---------------|-------------|-----------|-----------|-----------|-----------|-----|
| FMWHNC-60 | 60" Non-Combustible White | HTI 1 | \$ 1,239 | 21 | Y | 14 | 21 | N |

Non-Combustible White 72"



| | | Disc. Code | MSRP USD | 004 IA | 010 PA | 014 CA | 016 NC | EXP |
|-----------|---------------------------|---------------|-------------|-----------|-----------|-----------|-----------|-----|
| FMWHNC-72 | 72" Non-Combustible White | HTI 1 | \$ 1,389 | 21 | Y | 21 | 14 | N |

| | | |
|--|---|---|
| <h1 style="margin: 0;">Hearth & Home Technologies</h1> | <h2 style="margin: 0;">Samples - Wood Shelf Mantel</h2> | <p>Stocked Item/Lead Time</p> <p>004=Mt. Pleasant RDC 010=Kutztown RDC 014=Sacramento RDC 016=Charlotte RDC</p> <p>EXP=Factory Expedite Program</p> |
|--|---|---|

Prices in USD

Page printed 3/31/2025, 8:22:26 AM CDT
* Please Contact Who You Purchase This Through for MSRP Pricing

Non-stock and custom product cannot be cancelled.
Customer is responsible for freight for orders made outside of assigned RDC facility.

Baxter Shelf Sample

| | | | | | | | | | |
|---------|---------------------------------------|-------|--------|-----|-----|-----|-----|-----|--|
| | | Disc. | MSRP | | | | | | |
| | | Code | USD | 004 | 010 | 014 | 016 | EXP | |
| | IA | PA | CA | NC | EXP | | | | |
| FMBRMPY | Baxter Shelf Sample, Primed MDF | HTI 1 | \$ 111 | 21 | Y | 21 | 21 | Y | |
| FMBRAUY | Baxter Shelf Sample, Unfinished Maple | HTI 1 | \$ 141 | 14 | 28 | 35 | 35 | N | |

Crosby Shelf Sample

| | | | | | | | | | |
|---------|---------------------------------------|-------|--------|-----|-----|-----|-----|-----|--|
| | | Disc. | MSRP | | | | | | |
| | | Code | USD | 004 | 010 | 014 | 016 | EXP | |
| | | IA | PA | CA | NC | EXP | | | |
| FMCYMPY | Crosby Shelf Sample, Primed MDF | HTI 1 | \$ 111 | 21 | Y | 21 | 21 | Y | |
| FMCYAUU | Crosby Shelf Sample, Unfinished Maple | HTI 1 | \$ 141 | 14 | 28 | 35 | 35 | N | |

Fillmore Shelf Sample

| | | | | | | | | | |
|---------|-----------------------|----------|--------|-----|-----|-----|-----|-----|--|
| | | Disc. | MSRP | | | | | | |
| | | Code | USD | 004 | 010 | 014 | 016 | EXP | |
| | IA | PA | CA | NC | EXP | | | | |
| FMFEMPY | FILLMORE SHELF SAMPLE | HTI null | \$ 111 | 21 | Y | 21 | 21 | N | |

Ozark Shelf Sample

| | | | | | | | | | |
|---------|--------------------|----------|--------|-----|-----|-----|-----|-----|--|
| | | Disc. | MSRP | | | | | | |
| | | Code | USD | 004 | 010 | 014 | 016 | EXP | |
| | IA | PA | CA | NC | EXP | | | | |
| FMOKMPY | OZARK SHELF SAMPLE | HTI null | \$ 111 | 21 | Y | 21 | 21 | N | |

Hearth & Home Technologies

Marble, Granite & Slate

Stocked Item/Lead Time

004=Mt. Pleasant RDC
010=Kutztown RDC
014=Sacramento RDC
016=Charlotte RDC

EXP=Factory Expedite Program

Page printed 3/31/2025, 8:22:26 AM CDT

* Please Contact Who You Purchase This Through for MSRP Pricing

Prices in USD

Non-stock and custom product cannot be cancelled.

Customer is responsible for freight for orders made outside of assigned RDC facility.

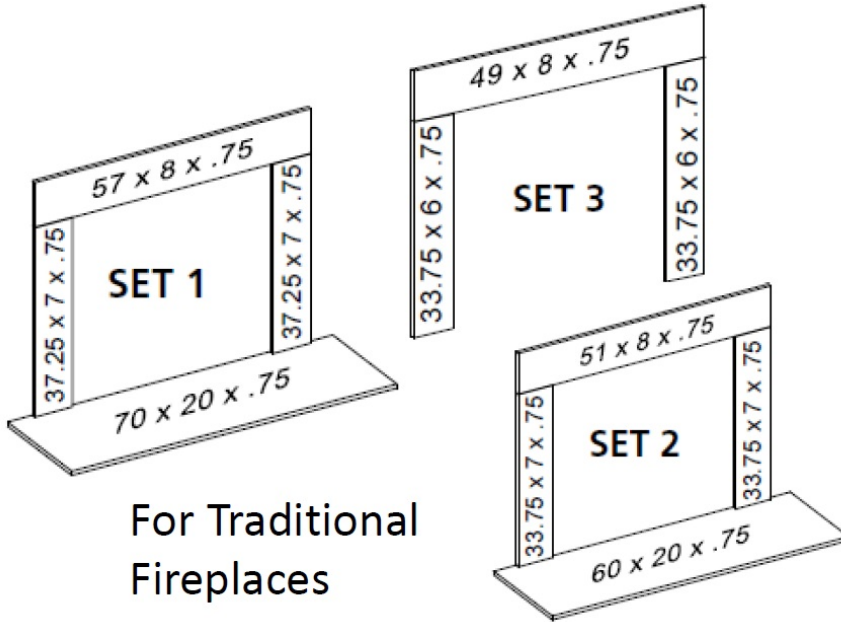

For Traditional Fireplaces

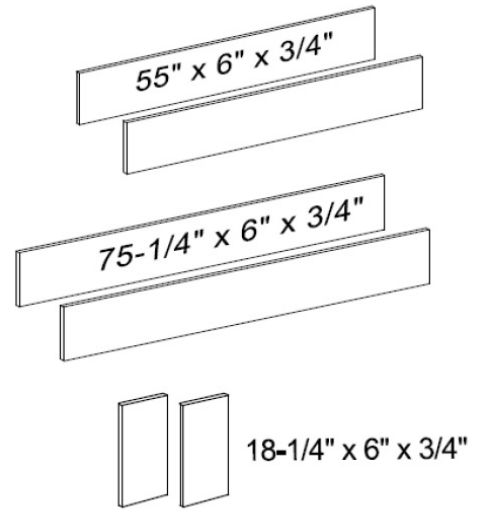

For Linear Fireplaces

Absolute Black Granite Set 1

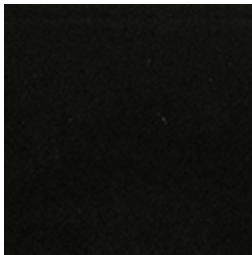

| | | Disc. Code | MSRP USD | 004 IA | 010 PA | 014 CA | 016 NC | EXP |
|------------|--|------------|----------|--------|--------|--------|--------|-----|
| MBBGMS1 | Absolute Black granite, Set 1 (must order in multiples of 6) | HTI 1 | \$ 969 | Y | Y | 14 | Y | N |
| MBBGMS1PK1 | Absolute Black granite, Set 1, single pack | HTI 1 | \$ 1,399 | 14 | 7 | 14 | 14 | N |

Absolute Black Granite Set 2

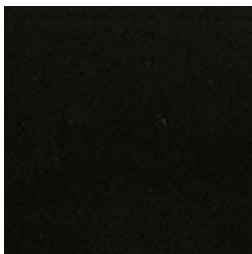

| | | Disc. Code | MSRP USD | 004 IA | 010 PA | 014 CA | 016 NC | EXP |
|------------|--|------------|----------|--------|--------|--------|--------|-----|
| MBBGMS2 | Absolute Black granite, Set 2 (must order in multiples of 6) | HTI 1 | \$ 899 | Y | Y | 14 | Y | N |
| MBBGMS2PK1 | Absolute Black granite, Set 2, single pack | HTI 1 | \$ 1,329 | 21 | 7 | 14 | 21 | N |

Absolute Black Set 3

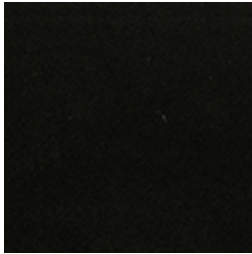

| | | Disc. Code | MSRP USD | 004 IA | 010 PA | 014 CA | 016 NC | EXP |
|------------|---------------------------|---------------|-------------|-----------|-----------|-----------|-----------|-----|
| MBBGMS3 | BLACK GRANITE SET 3 MPK-6 | HTI 1 | \$ 589 | 14 | Y | 14 | Y | N |
| MBBGMS3PK1 | BLACK GRANITE SET 3 SPK | HTI 1 | \$ 1,029 | 14 | 7 | 14 | 14 | N |

Beige Marble Set 1



| | | Disc. Code | MSRP USD | 004 IA | 010 PA | 014 CA | 016 NC | EXP |
|-------------|-------------------|---------------|-------------|-----------|-----------|-----------|-----------|-----|
| MBBEEMS1 | BEIGE SET 1 MPK-6 | HTI 1 | \$ 1,089 | 91 | Y | 91 | Y | N |
| MBBEEMS1PK1 | BEIGE SET SPK | HTI 1 | \$ 1,509 | 91 | 91 | 91 | 91 | N |

Beige Marble Set 2



| | | Disc. Code | MSRP USD | 004 IA | 010 PA | 014 CA | 016 NC | EXP |
|-------------|-------------------|---------------|-------------|-----------|-----------|-----------|-----------|-----|
| MBBEEMS2 | BEIGE SET 2 MPK-6 | HTI 1 | \$ 1,029 | 91 | Y | 91 | 91 | N |
| MBBEEMS2PK1 | BEIGE SET 2 SPK | HTI 1 | \$ 1,449 | 91 | 91 | 91 | 91 | N |

Beige set 3



| | | Disc. Code | MSRP USD | 004 IA | 010 PA | 014 CA | 016 NC | EXP |
|-------------|--|---------------|-------------|-----------|-----------|-----------|-----------|-----|
| MBBEEMS3 | Beige Set 3, (must be ordered in multiples of 6) | HTI 1 | \$ 689 | 14 | Y | 14 | 14 | N |
| MBBEEMS3PK1 | Beige Set 3, single pack | HTI 1 | \$ 1,109 | 14 | 7 | 14 | 21 | N |

Bianco White set 1

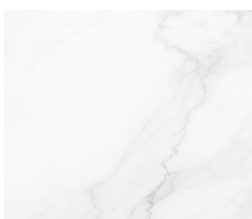

| | | Disc. Code | MSRP USD | 004 IA | 010 PA | 014 CA | 016 NC | EXP |
|------------|---|---------------|-------------|-----------|-----------|-----------|-----------|-----|
| MBBVMS1 | Bianco White Marble, Set 1 (Must order in multiples of 6) | HTI 1 | \$ 969 | Y | Y | 14 | Y | N |
| MBBVMS1PK1 | Bianco White Marble, Set 1, single pack | HTI 1 | \$ 1,399 | 21 | 7 | 21 | 21 | N |

Bianco White set 2



| | | Disc. Code | MSRP USD | 004 IA | 010 PA | 014 CA | 016 NC | EXP |
|------------|---|---------------|-------------|-----------|-----------|-----------|-----------|-----|
| MBBVMS2 | Bianco White Marble, Set 2 (Must order in multiples of 6) | HTI 1 | \$ 899 | 21 | Y | 14 | Y | N |
| MBBVMS2PK1 | Bianco White Marble, Set 2, single pack | HTI 1 | \$ 1,329 | 21 | 7 | 14 | 21 | N |

Bianco White set 3



| | | Disc. Code | MSRP USD | 004 IA | 010 PA | 014 CA | 016 NC | EXP |
|------------|---|---------------|-------------|-----------|-----------|-----------|-----------|-----|
| MBBVMS3 | Bianco White Marble, Set 3 (must order 6) | HTI 1 | \$ 589 | 21 | Y | 14 | Y | N |
| MBBVMS3PK1 | Bianco White Marble, Set 3, single pack | HTI 1 | \$ 1,029 | 21 | 7 | 14 | 21 | N |

Blue Tundra set 1



| | | Disc. Code | MSRP USD | 004 IA | 010 PA | 014 CA | 016 NC | EXP |
|-------------|---|---------------|-------------|-----------|-----------|-----------|-----------|-----|
| MBBTAMS1 | Blue Tundra Marble, Set 1 (must be ordered in multiples of 6) | HTI 1 | \$ 1,089 | 21 | Y | 21 | Y | N |
| MBBTAMS1PK1 | Blue Tundra Marble, Set 1, single pack | HTI 1 | \$ 1,509 | 21 | 21 | 21 | 21 | N |

Blue Tundra set 2



| | | Disc. Code | MSRP USD | 004 IA | 010 PA | 014 CA | 016 NC | EXP |
|-------------|---|---------------|-------------|-----------|-----------|-----------|-----------|-----|
| MBBTAMS2 | Blue Tundra Marble, Set 2 (must be ordered in multiples of 6) | HTI 1 | \$ 1,029 | 21 | Y | 14 | Y | N |
| MBBTAMS2PK1 | Blue Tundra Marble, Set 2, single pack | HTI 1 | \$ 1,449 | 21 | 7 | 14 | 21 | N |

Blue Tundra set 3



| | | Disc. Code | MSRP USD | 004 IA | 010 PA | 014 CA | 016 NC | EXP |
|-------------|---|---------------|-------------|-----------|-----------|-----------|-----------|-----|
| MBBTAMS3 | Blue Tundra marble, Set 3 (must be ordered in multiples of 6) | HTI 1 | \$ 689 | 21 | Y | 21 | 14 | N |
| MBBTAMS3PK1 | Blue Tundra marble, Set 3, single pack | HTI 1 | \$ 1,109 | 21 | 7 | 21 | 21 | N |

Driftwood 55 x 6 Linear Header, Riser



| | Disc. Code | MSRP USD | 004 | 010 | 014 | 016 | EXP |
|----------|--|-------------|-----|-----|-----|-----|-----|
| | | | IA | PA | CA | NC | |
| MBDD55X6 | Driftwood Marble, one header, one riser, 55 x 6 x HTI 1 .75 | \$ 329 | 21 | Y | 21 | 21 | N |

Driftwood 75.25 x 6 Linear Header, riser



| | Disc. Code | MSRP USD | 004 | 010 | 014 | 016 | EXP |
|------------|---|-------------|-----|-----|-----|-----|-----|
| | | | IA | PA | CA | NC | |
| MBDD7525X6 | Driftwood Marble, one header, one riser, 75.25 x HTI 1 6 x .75 | \$ 469 | 21 | Y | 21 | 21 | N |

Driftwood Linear Legs (2)



| | Disc. Code | MSRP USD | 004 | 010 | 014 | 016 | EXP |
|------------|---|-------------|-----|-----|-----|-----|-----|
| | | | IA | PA | CA | NC | |
| MBDD1825X6 | Driftwood Marble, two legs, 18.25 x 6 x .75 | \$ 80 | 21 | Y | 21 | 21 | N |

Driftwood set 1



| | Disc. Code | MSRP USD | 004 | 010 | 014 | 016 | EXP |
|------------|---|-------------|-----|-----|-----|-----|-----|
| | | | IA | PA | CA | NC | |
| MBDDMS1 | Driftwood Marble, Set 1 (must be ordered in multiples of 6) | \$ 969 | 21 | Y | 14 | Y | N |
| MBDDMS1PK1 | Driftwood Marble, Set 1, single pack | \$ 1,399 | 21 | 7 | 14 | 21 | N |

Driftwood set 2



| | Disc. Code | MSRP USD | 004 | 010 | 014 | 016 | EXP |
|------------|---|-------------|-----|-----|-----|-----|-----|
| | | | IA | PA | CA | NC | |
| MBDDMS2 | Driftwood Marble, Set 2 (must be ordered in multiples of 6) | \$ 899 | 21 | Y | 14 | Y | N |
| MBDDMS2PK1 | Driftwood Marble, Set 2, single pack | \$ 1,329 | 14 | 7 | 21 | 21 | N |

Driftwood set 3



| | | Disc. Code | MSRP USD | 004 IA | 010 PA | 014 CA | 016 NC | EXP |
|------------|---|---------------|-------------|-----------|-----------|-----------|-----------|-----|
| MBDDMS3 | Driftwood marble, Set 3 (must be ordered in multiples of 6) | HTI 1 | \$ 589 | 91 | Y | 91 | 91 | N |
| MBDDMS3PK1 | Driftwood marble, Set 3 single pack | HTI 1 | \$ 1,029 | 91 | 91 | 91 | 91 | N |

New Venetian Granite Set 1



| | | Disc. Code | MSRP USD | 004 IA | 010 PA | 014 CA | 016 NC | EXP |
|---------|--|---------------|-------------|-----------|-----------|-----------|-----------|-----|
| MBOGMS1 | New Venetian Granite, Set 1 (must order in multiples of 6) | HTI 1 | \$ 789 | 8 | Y | 14 | Y | N |

New Venetian Granite Set 2

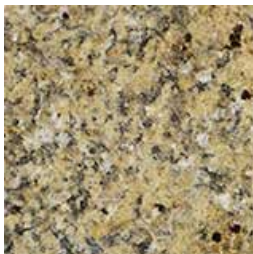

| | | Disc. Code | MSRP USD | 004 IA | 010 PA | 014 CA | 016 NC | EXP |
|---------|--|---------------|-------------|-----------|-----------|-----------|-----------|-----|
| MBOGMS2 | New Venetian Granite, Set 2 (must order in multiples of 6) | HTI 1 | \$ 739 | 21 | Y | 28 | Y | N |

New Venetian set 3



| | | Disc. Code | MSRP USD | 004 IA | 010 PA | 014 CA | 016 NC | EXP |
|---------|--|---------------|-------------|-----------|-----------|-----------|-----------|-----|
| MBOGMS3 | New Venetian Granite, Set 3 (must be ordered in multipse of 6) | HTI 1 | \$ 469 | 21 | 14 | 21 | 21 | N |

Parchwood set 3



| | | Disc. Code | MSRP USD | 004 IA | 010 PA | 014 CA | 016 NC | EXP |
|---------|---|---------------|-------------|-----------|-----------|-----------|-----------|-----|
| MBPDMS3 | Parchwood marble, Set 3 (must be ordered in multiples of 6) | HTI 1 | \$ 589 | 21 | 14 | 21 | 21 | N |

Pauline Granite Set 1



| | Disc. Code | MSRP USD | 004 | 010 | 014 | 016 | EXP |
|--|------------|----------|-----|-----|-----|-----|-----|
| | | | IA | PA | CA | NC | |
| MBPEMS1 | HTI 1 | \$ 789 | 21 | Y | 21 | 21 | N |
| Pauline Granite, Set 1 (must be ordered in multiples of 6) | | | | | | | |

Pauline Granite Set 2



| | Disc. Code | MSRP USD | 004 | 010 | 014 | 016 | EXP |
|---|------------|----------|-----|-----|-----|-----|-----|
| | | | IA | PA | CA | NC | |
| MBPEMS2 | HTI 1 | \$ 739 | 14 | Y | 21 | Y | N |
| Pauline Granite, Set 2 (must order in multiples of 6) | | | | | | | |

Pauline Granite Set 3



| | Disc. Code | MSRP USD | 004 | 010 | 014 | 016 | EXP |
|---|------------|----------|-----|-----|-----|-----|-----|
| | | | IA | PA | CA | NC | |
| MBPEMS3 | HTI 1 | \$ 469 | 21 | Y | 21 | 21 | N |
| Pauline granite, Set 3 (must order in multiples of 6) | | | | | | | |

Slate 37.25X7

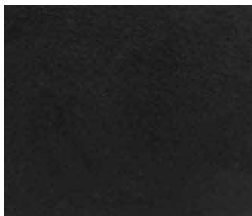

| | Disc. Code | MSRP USD | 004 | 010 | 014 | 016 | EXP |
|---|------------|----------|-----|-----|-----|-----|-----|
| | | | IA | PA | CA | NC | |
| MBSR3725X7-C | HTI 1 | \$ 78 | 21 | Y | 14 | Y | N |
| Slate Legs 37.25X7X5/8 (must be ordered in multiples of 50) | | | | | | | |

Slate 51X8

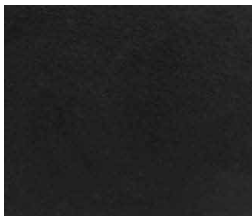

| | Disc. Code | MSRP USD | 004 | 010 | 014 | 016 | EXP |
|--|------------|----------|-----|-----|-----|-----|-----|
| | | | IA | PA | CA | NC | |
| MBSR51X8-C | HTI 1 | \$ 142 | 21 | Y | 14 | Y | N |
| Slate Header 51X8X5/8 (must be ordered in multiples of 25) | | | | | | | |

Slate 57X8



| | | Disc. Code | MSRP USD | 004 IA | 010 PA | 014 CA | 016 NC | EXP |
|------------|--|---------------|-------------|-----------|-----------|-----------|-----------|-----|
| MBSR57X8-C | Slate Header 57X8X5/8 (must be ordered in multiples of 25) | HTI 1 | \$ 142 | 21 | Y | 14 | Y | N |

Slate 60X20



| | | Disc. Code | MSRP USD | 004 IA | 010 PA | 014 CA | 016 NC | EXP |
|-------------|---|---------------|-------------|-----------|-----------|-----------|-----------|-----|
| MBSR60X20-C | Slate Hearth 60X20X5/8 (must be ordered in multiples of 25) | HTI 1 | \$ 339 | 21 | Y | 14 | Y | N |

Slate 70x20"

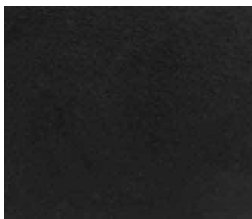

| | | Disc. Code | MSRP USD | 004 IA | 010 PA | 014 CA | 016 NC | EXP |
|-------------|---|---------------|-------------|-----------|-----------|-----------|-----------|-----|
| MBSR70X20-C | Slate Hearth 70X20X5/8 (must be ordered in multiples of 25) | HTI 1 | \$ 419 | 28 | Y | 14 | Y | N |

Steel Gray Granite set 1

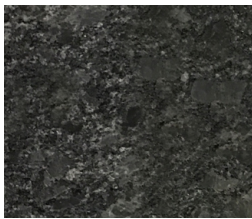

| | | Disc. Code | MSRP USD | 004 IA | 010 PA | 014 CA | 016 NC | EXP |
|------------|--|---------------|-------------|-----------|-----------|-----------|-----------|-----|
| MBSGMS1 | Steel Gray granite, Set 1 (must order in multiples of 6) | HTI 1 | \$ 969 | Y | Y | 21 | Y | N |
| MBSGMS1PK1 | Steel Gray granite, Set 1, single pack | HTI 1 | \$ 1,399 | 21 | 7 | 14 | 21 | N |

Steel Gray set 2

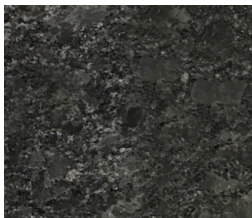

| | | Disc. Code | MSRP USD | 004 IA | 010 PA | 014 CA | 016 NC | EXP |
|------------|--|---------------|-------------|-----------|-----------|-----------|-----------|-----|
| MBSGMS2 | Steel Gray granite, Set 2 (must order in multiples of 6) | HTI 1 | \$ 899 | 21 | Y | 14 | Y | N |
| MBSGMS2PK1 | Steel Gray granite, Set 2, single pack | HTI 1 | \$ 1,329 | 21 | 7 | 14 | 21 | N |

Steel Gray set 3

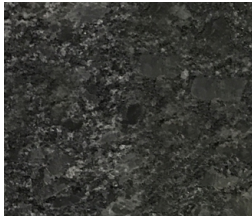

| | | Disc. Code | MSRP USD | 004 IA | 010 PA | 014 CA | 016 NC | EXP |
|------------|---|---------------|-------------|-----------|-----------|-----------|-----------|-----|
| MBSGMS3 | Steel Gray Granite, Set 3 (must be ordered in multiples of 6) | HTI 1 | \$ 589 | 21 | Y | 21 | 21 | N |
| MBSGMS3PK1 | Steel Gray Granite, Set 3, single pack | HTI 1 | \$ 1,029 | 21 | 21 | 21 | 21 | N |

Thala Beige set 2



| | | Disc. Code | MSRP USD | 004 IA | 010 PA | 014 CA | 016 NC | EXP |
|---------|---|---------------|-------------|-----------|-----------|-----------|-----------|-----|
| MBTEMS2 | Thala Beige Marble, Set 2 (must be ordered in multiples of 6) | HTI 1 | \$ 1,029 | 14 | Y | 21 | Y | N |

Thala Beige set 3



| | | Disc. Code | MSRP USD | 004 IA | 010 PA | 014 CA | 016 NC | EXP |
|---------|--|---------------|-------------|-----------|-----------|-----------|-----------|-----|
| MBTEMS3 | Thala Beige, Set 3 (must be ordered in multiples of 6) | HTI 1 | \$ 689 | 21 | Y | 21 | 21 | N |

Heat&Glo - Fireside Finishings Recommended Mantel, and Surround Reference Sheet

Recommendations based on clearance to combustibles listed in installation instructions. If space is left blank, there are no mantel recommendation at this time.

* NOTE: Hearth must be cut to fit between legs of mantel or recessed to be flush with the floor. Mantle set sizes are minimum size required to fit. Larger sets may be used depending on desired look. Additional cuts may be required.

** Some or all components must be cut to properly fit this linear fireplace model.

This sheet is intended to be used as a quick reference guide only. Use the HHT Natural Stone Sizing Guide for specific details on dimensions to cut legs/hearths.

| Unit Series | HHT Brand | Mantle | SELECT | | | SIGNATURE | | | | | | DESIGN | | | | WOOD SHELVES Fillmore, Baxter, Crosby, Clark | Minimum combustible mantel clearances measured from top of firebox opening | | | | |
|------------------|-----------|-------------|----------|-------------|---------|-----------|---------|-------------|---------|------------|--------|----------|--------|--------|--------|---|--|-----------------|-----------------|-----------------|------------------|
| | | | Richland | Richland RS | Wescott | Acadia | Kenwood | Kenwood B&O | Merritt | Roxborough | Zimmer | Burfield | Laurel | Maibne | Walker | | 3" Mantle Depth | 5" Mantle Depth | 7" Mantle Depth | 8" Mantle Depth | 12" Mantle Depth |
| PHOENIX 42 | HNG | Mantle Size | | | | | | | | | | | | | | 59" / 72" | | | | | 12" |
| | | NS Set Size | | | | | | | | | | | | | | | | | | | |
| PIER-36 | HNG | Mantle Size | | | | | | | | | | | | | | 48" | 10" | 12" | 14" | 15" | 19" |
| | | NS Set Size | | | | | | | | | | | | | | | | | | | |
| PRIMO II 48 & 5T | HNG | Mantle Size | | | | | | | | | | | | | | 59" / 72" | | | | | |
| | | NS Set Size | | | | | | | | | | | | | | | | | | | |
| PRIMO II 60 & 5T | HNG | Mantle Size | | | | | | | | | | | | | | 72" | | | | | |
| | | NS Set Size | | | | | | | | | | | | | | | | | | | |
| PRIMO II 72 & 5T | HNG | Mantle Size | | | | | | | | | | | | | | 72" | | | | | |
| | | NS Set Size | | | | | | | | | | | | | | | | | | | |
| RH 36 | HNG | Mantle Size | B | | B | B | B | B | B | B | B | B | B | B | | 48" / 59" | | | | | 12" |
| | | NS Set Size | 2 | | 2 | 1 | 1 | 2 | 1 | 2 | 1 | 1 | 1 | 1 | | | | | | | |
| RH 42 | HNG | Mantle Size | C | | C | C | C | | C | C | C | C | C | C | | 59" / 72" | | | | | 12" |
| | | NS Set Size | 1 | | 1 | 1 | 1 | | 1 | 1 | 1 | 1 | 1 | 1 | | | | | | | |
| Rutherford 36 | HNG | Mantle Size | | | | | | | | | | | | | | 48" / 59" | | | | | 22" |
| | | NS Set Size | | | | | | | | | | | | | | | | | | | |
| Rutherford 42 | HNG | Mantle Size | | | | | | | | | | | | | | 59" / 72" | | | | | 22" |
| | | NS Set Size | | | | | | | | | | | | | | | | | | | |
| Rutherford 50 | HNG | Mantle Size | | | | | | | | | | | | | | 59" / 72" | | | | | 22" |
| | | NS Set Size | | | | | | | | | | | | | | | | | | | |
| SL3X | HNG | Mantle Size | A | X | A | A | A | | A | A | A | | | | | 48" | 4" | 6" | 8" | 9" | 13" |
| | | NS Set Size | 3 | 3 | 3 | 3 | 3 | | 3 | 3 | 3 | | | | | | | | | | |
| SL-5/5X | HNG | Mantle Size | A | X | A | A | A | | A | A | A | | | | | 48" / 59" | 4" | 6" | 8" | 9" | 13" |
| | | NS Set Size | 3 | 3 | 3 | 3 | 3 | | 3 | 3 | 3 | | | | | | | | | | |
| SL-7/7X | HNG | Mantle Size | B | | B | B | B | B | B | B | B | B | B | B | | 59" / 72" | 4" | 6" | 8" | 9" | 13" |
| | | NS Set Size | 2 | | 2 | 1 | 1 | 2 | 1 | 2 | 1 | 1 | 1 | 1 | | | | | | | |
| SL-9/9X | HNG | Mantle Size | C | | C | C | C | | C | C | C | C | C | C | | 72" | 4" | 6" | 8" | 9" | 13" |
| | | NS Set Size | 1 | | 1 | 1 | 1 | | 1 | 1 | 1 | 1 | 1 | 1 | | | | | | | |
| ST-36TR/TRB | HNG | Mantle Size | B | | B | B | B | B | B | B | B | B | B | B | | 48" / 59" | 10" | 12" | 14" | 15" | 19" |
| | | NS Set Size | 2 | | 2 | 1 | 1 | 2 | 1 | 2 | 1 | 1 | 1 | 1 | | | | | | | |
| ST-32 | HNG | Mantle Size | A | X | A | A | A | | A | A | A | | | | | 48" / 59" | 10" | 12" | 14" | 15" | 19" |
| | | NS Set Size | 3 | 3 | 3 | 3 | 3 | | 3 | 3 | 3 | | | | | | | | | | |
| TRUE 36 | HNG | Mantle Size | | | | | | | | | | | | | | 48" / 59" | 12" | 16" | 19" | 20" | 23" |
| | | NS Set Size | | | | | | | | | | | | | | | | | | | |
| TRUE 42 | HNG | Mantle Size | | | | | | | | | | | | | | 59" / 72" | 15" | 17" | 20" | 21" | 24" |
| | | NS Set Size | | | | | | | | | | | | | | | | | | | |
| TRUE 50 | HNG | Mantle Size | | | | | | | | | | | | | | 59" / 72" | 13 | 18" | 21" | 22" | 25" |
| | | NS Set Size | | | | | | | | | | | | | | | | | | | |

Heat&Glo - Fireside Finishings Recommended Mantel, and Surround Reference Sheet

Recommendations based on clearance to combustibles listed in installation instructions. If space is left blank, there are no mantel recommendation at this time.

* NOTE: Hearth must be cut to fit between legs of mantel or recessed to be flush with the floor. Mantel set sizes are minimum size required to fit. Larger sets may be used depending on desired look. Additional cuts may be required.

** Some or all components must be cut to properly fit this linear fireplace model.

This sheet is intended to be used as a quick reference guide only. Use the HHT Natural Stone Sizing Guide for specific details on dimensions to cut legs/hearths.

| Unit Series | HHT Brand | Mantel | SELECT | | | SIGNATURE | | | | | | DESIGN | | | | WOOD SHELVES Fillmore, Baxter, Crosby, Clark | Minimum combustible mantel clearances measured from top of firebox opening | | | | |
|------------------|-----------|---------------|----------|-------------|---------|-----------|---------|-------------|--------|------------|--------|-------------|--------|--------|--------|--|--|-----------------|-----------------|-----------------|------------------|
| | | | Richland | Richland RS | Wescott | Acadia | Kenwood | Kenwood B&O | Meritt | Roxborough | Zimmer | Battlefield | Laurel | Maabne | Walker | | 3" Mantel Depth | 5" Mantel Depth | 7" Mantel Depth | 8" Mantel Depth | 12" Mantel Depth |
| 6K/KL Series | HNG | Mantel Size | B | | B | B | B | B | B | B | B | B | B | B | | 59" / 72" | 10" | 12" | 14" | 15" | 19" |
| | | NS Set Size | 2 | | 2 | 2 | 2 | 2 | 2 | 2 | 2 | 2 | 2 | 2 | | | | | | | |
| 6K Modern Series | HNG | Mantel Size | B | | B | B | B | B | B | B | B | B | B | B | | 59" / 72" | 10" | 12" | 14" | 15" | 19" |
| | | NS Set Size | 2 | | 2 | 2 | 2 | 2 | 2 | 2 | 2 | 2 | 2 | 2 | | | | | | | |
| 8K/KL Series | HNG | Mantel Size | C | | C | C | C | | C | C | C | C | C | C | | 59" / 72" | 10" | 12" | 14" | 15" | 19" |
| | | NS Set Size | 1 | | 1 | 1 | 1 | | 1 | 1 | 1 | 1 | 1 | 1 | | | | | | | |
| 8K Modern Series | HNG | Mantel Size | C | | C | C | C | | C | C | C | C | C | C | | 59" / 72" | 10" | 12" | 14" | 15" | 19" |
| | | NS Set Size | 1 | | 1 | 1 | 1 | | 1 | 1 | 1 | 1 | 1 | 1 | | | | | | | |
| 6CX Series | HNG | Mantel Size | B | | B | B | B | B | B | B | B | B | B | B | | 59" / 72" | 10" | 12" | 14" | 15" | 19" |
| | | NS Set Size | 2 | | 2 | 2 | 2 | 2 | 2 | 2 | 2 | 2 | 2 | 2 | | | | | | | |
| 8CX Series | HNG | Mantel Size | C | | C | C | C | | C | C | C | C | C | C | | 59" / 72" | 10" | 12" | 14" | 15" | 19" |
| | | NS Set Size | 1 | | 1 | 1 | 1 | | 1 | 1 | 1 | 1 | 1 | 1 | | | | | | | |
| Cerona 36 | HNG | Mantel Size | | | | | | | | | | | | | | 48" / 59" | 13" | 15" | 17" | 18" | 22" |
| | | NS Set Size | | | | | | | | | | | | | | | | | | | |
| Cerona 42 | HNG | Mantel Size | | | | | | | | | | | | | | 59" / 72" | 13" | 15" | 17" | 18" | 22" |
| | | NS Set Size | | | | | | | | | | | | | | | | | | | |
| Cosmo 32 | HNG | Mantel Size | | | | | | | | | | | | | | 48" | 9" | 10" | 11" | 13" | 14" |
| | | NS Set Size** | | | | | | | | | | | | | | MBDD55X6 header & riser; MBDD1825X6 legs | | | | | |
| Cosmo 36 | HNG | Mantel Size | | | | | | | | | | | | | | 48" / 59" | 9" | 10" | 11" | 13" | 14" |
| | | NS Set Size** | | | | | | | | | | | | | | MBDD55X6 header & riser; MBDD1825X6 legs | | | | | |
| Cosmo 42 | HNG | Mantel Size | | | | | | | | | | | | | | 59" / 72" | 9" | 10" | 11" | 13" | 14" |
| | | NS Set Size | | | | | | | | | | | | | | MBDD55X6 header & riser; MBDD1825X6 legs | | | | | |
| EM415 | HNG | Mantel Size | B | | B | B | B | B | B | B | B | B | B | B | | 48" | 9" | | | | 12" |
| | | NS Set Size | 2 | | 2 | 1 | 1 | 2 | 1 | 2 | 1 | 1 | 1 | 1 | | | | | | | |
| Escape 42ST | HNG | Mantel Size | | | | | | | | | | | | | | 59" / 72" | | | | | 10" |
| | | NS Set Size | | | | | | | | | | | | | | | | | | | |
| Exclaim 36 | HNG | Mantel Size | | | | | | | | | | | | | | 48" / 59" | 9" | | | | 12" |
| | | NS Set Size | | | | | | | | | | | | | | | | | | | |
| Exclaim 42 | HNG | Mantel Size | | | | | | | | | | | | | | 59" / 72" | 9" | | | | 12" |
| | | NS Set Size | | | | | | | | | | | | | | | | | | | |
| Exclaim 50 | HNG | Mantel Size | | | | | | | | | | | | | | 59" / 72" | 13" | | | | 20" |
| | | NS Set Size | | | | | | | | | | | | | | | | | | | |
| MEIZO 36 & ST | HNG | Mantel Size | | | | | | | | | | | | | | 48" / 59" | 20" | 22" | 24" | 25" | 29" |
| | | NS Set Size | | | | | | | | | | | | | | MBTE55X6/MBDD55X6 header & riser; MBTE1825X6/MBDD1825X6 legs | | | | | |
| MEIZO 48 & ST | HNG | Mantel Size | | | | | | | | | | | | | | 59" / 72" | 20" | 22" | 24" | 25" | 29" |
| | | NS Set Size** | | | | | | | | | | | | | | MBTE7525X6/MBDD7525X6 header & riser; MBTE1825X6/MBDD1825X6 legs | | | | | |
| MEIZO 60 & ST | HNG | Mantel Size | | | | | | | | | | | | | | 72" | 24" | 23" | 28" | 29" | 30" |
| | | NS Set Size** | | | | | | | | | | | | | | MBTE7525X6/MBDD7525X6 header & riser; MBTE1825X6/MBDD1825X6 legs | | | | | |
| MEIZO 72 & ST | HNG | Mantel Size | | | | | | | | | | | | | | 72" | 24" | 23" | 28" | 29" | 30" |
| | | NS Set Size | | | | | | | | | | | | | | | | | | | |
| Northstar | HNG | Mantel Size | | | | | | | | | | | | | | 59" / 72" | | | | | 31.375" |
| | | NS Set Size | | | | | | | | | | | | | | | | | | | |