

# AMERICAN F<sup>Y</sup>RE DESIGNS™

outdoor products collection

AFD PRODUCTS ARE FOR OUTDOOR USE ONLY



CRAFTED WITH PRIDE  IN THE USA

## TABLE OF CONTENTS

DESCRIPTION	PAGE
Fireplaces	2-3
Fireplace Accessories	4-5
Chat Height Firetables	6-7
Dining Height Firetables	8
Fire Bowls	9-10
Fire Pits	10
Fire Urns & Lanterns	11
Fyre Glass, Fyre Gems, & Diamond Nuggets	12
Fyre Spheres, Outdoor Gas Logs, Stones, & Lava Media	13
Protective Covers & Tank/End Tables	14
Glass Wind Guards, Conversion Kits, & Repl. Burners	15
Ordering Guide & Warranty Information	16

## STEP 1: (Choose a Vented or Vent Free Fireplace)

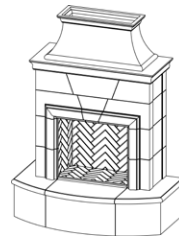
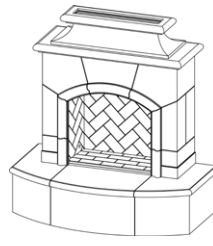
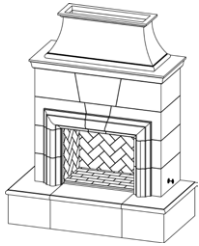

Cordova	
Vented #:	<b>022-XX-X-XX-XXC</b>
Vent-Free #:	<b>122-XX-X-XX-XXC</b>
Dimensions:	76"w x 41"d x 95"h
Wt. (lbs) / Pcs.:	1700 / 11
Vented:	<b>\$10,324</b>
Vent-Free:	<b>\$10,858</b>

Phoenix	
Vented #:	<b>017-XX-X-XX-XXC</b>
Vent-Free #:	<b>117-XX-X-XX-XXC</b>
Dimensions:	65"w x 36"d x 87"h
Wt. (lbs) / Pcs.:	1100 / 7
Vented:	<b>\$6,722</b>
Vent-Free:	<b>\$7,282</b>

Mariposa	
Vented #:	<b>073-XX-X-XX-XXC</b>
Vent-Free #:	<b>173-XX-X-XX-XXC</b>
Dimensions:	65"w x 36"d x 67"h
Wt. (lbs) / Pcs.:	970 / 7
Vented:	<b>\$6,722</b>
Vent-Free:	<b>\$7,282</b>

Petite Cordova	
Vented #:	<b>025-XX-X-XX-XXC</b>
Vent-Free #:	<b>125-XX-X-XX-XXC</b>
Dimensions:	65"w x 36"d x 84"h
Wt. (lbs) / Pcs.:	1100 / 10
Vented:	<b>\$6,722</b>
Vent-Free:	<b>\$7,282</b>

## STEP 2: (Choose Hearth Style)

### Compatible Hearths for Cordova

HEARTH DESCRIPTION	DIMENSIONS	MODEL #	PRICE
<b>A</b> 16" Rectangle Bullnose	76"w x 41"d x 16"h	xxx-20-x-xx-xxC	N/C
<b>B</b> 110" Rectangle Extended Bullnose	110"w x 41"d x 16"h	xxx-35-x-xx-xxC	<b>\$857</b>

### Compatible Hearths for Phoenix, Mariposa & Petite Cordova

HEARTH DESCRIPTION	DIMENSIONS	MODEL #	PRICE
<b>C</b> 16" Radiused Bullnose	65"w x 36"d x 16"h	xxx-01-x-xx-xxC	N/C
<b>D</b> 113" Extended Bullnose	113"w x 36"d x 16"h	xxx-05-x-xx-xxC	<b>\$736</b>

All Fireplaces shown and weighed with 16" standard hearth. Extended hearths add **two additional** pieces to the total count.

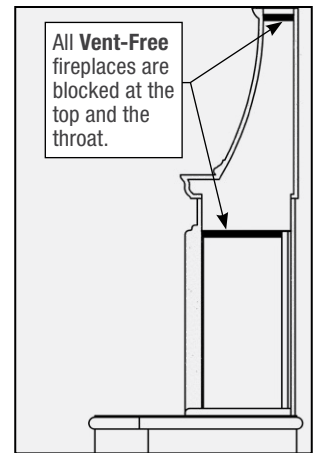

Vent-Free Fireplaces are **certified** to go under a covered area.

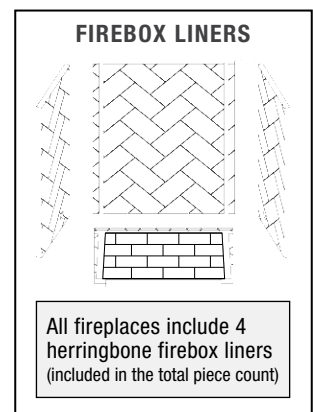

## STEP 3: (Choose Recess Option)

### 2" RECESS OPTIONS for above Fireplaces & Hearths

No Recess	xxx-xx- <b>N</b> -xx-xxC	N/C
Hearth Only	xxx-xx- <b>H</b> -xx-xxC	<b>\$523</b>
Hearth & Body	xxx-xx- <b>A</b> -xx-xxC	<b>523</b>

Fireplaces may be ordered with **recessed** hearth and/or body to accommodate field cladding in tile, stone or other veneer.

## STEP 1 & 2

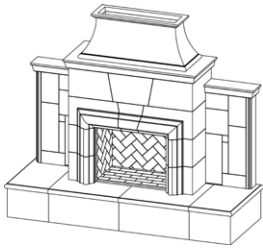

Grand Cordova (w/ Rectangle Extended Bullnose Hearth)	
Vented #:	<b>882-35-X-XX-XXC</b>
Vent-Free #:	<b>182-35-X-XX-XXC</b>
Dimensions:	110"w x 41"d x 95"h
Wt. (lbs) / Pcs.:	1900 / 13
Vented:	<b>\$13,563</b>
Vent-Free:	<b>\$14,165</b>

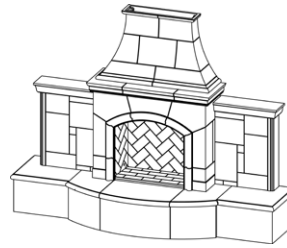

Grand Phoenix (w/ Extended Bullnose Hearth)	
Vented #:	<b>818-05-X-XX-XXC</b>
Vent-Free #:	<b>118-05-X-XX-XXC</b>
Dimensions:	113"w x 36"d x 87"h
Wt. (lbs) / Pcs.:	1400 / 15
Vented:	<b>\$10,324</b>
Vent-Free:	<b>\$10,925</b>

## STEP 3

### RECESS OPTIONS for above Fireplaces & Hearths

No Recess	XXX-XX- <b>N</b> -XX-XXC	N/C
Hearth Only	XXX-XX- <b>H</b> -XX-XXC	<b>\$523</b>

Grand Fireplaces may be ordered with **recessed** hearth to accommodate field cladding in tile, stone or other veneer.

## STEP 1, 2, & 3

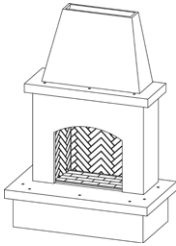

Contractor's Model	
Vented #:	<b>040-11-A-WC-RBC</b>
Vent-Free #:	<b>140-11-A-WC-RBC</b>
Dimensions:	67"w x 37"d x 96"h
Wt. (lbs) / Pcs.:	810 / 9
Vented:	<b>\$4,462</b>
Vent-Free:	<b>\$5,052</b>

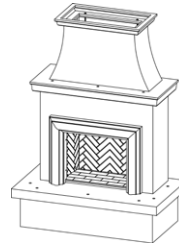

Contractor's Model with Moulding	
Vented #:	<b>045-11-A-WC-RBC</b>
Vent-Free #:	<b>145-11-A-WC-RBC</b>
Dimensions:	67"w x 37"d x 91"h
Wt. (lbs) / Pcs.:	810 / 9
Vented:	<b>\$5,052</b>
Vent-Free:	<b>\$5,640</b>

**Note:** Contractor's Model Fireplaces come in **White (GFRC) finish only**, recessed to accommodate field cladding, and with the key/gas location on the right out the back only.

## STEP 1, 2, & 3



Milan Tall Linear Fireplace *	
Model #:	<b>211-TA-N-XX-M8xC</b>
Dimensions:	72"w x 16"d x 60"h
Wt. (lbs) / Pcs.:	730 / 9
Price:	<b>\$9,033</b>

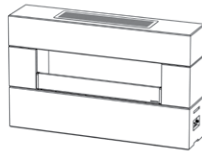

Milan Low Linear Fireplace *	
Model #:	<b>211-LO-N-XX-M8xC</b>
Dimensions:	72"w x 16"d x 44"h
Wt. (lbs) / Pcs.:	560 / 8
Price:	<b>\$7,405</b>

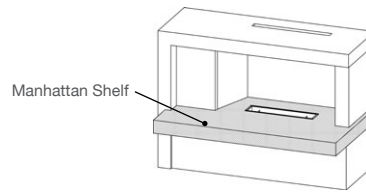

Manhattan (w/ Mirror Stainless Steel Liner)	
Model #:	<b>082-xx-N-XX-M3NC</b>
Dimensions:	59"w x 32"d x 42"h
Wt. (lbs) / Pcs.:	750 / 8
Price:	<b>\$7,993</b>

The Manhattan comes with a Natural Gas burner. For Propane change the **next to last** digit from an "N" to a "P". Manhattan Propane version has access door to house a Propane tank.

### MANHATTAN ONLY

SHELF COLOR	MODEL #
White Aspen	XXX- <b>WA</b> -X-XX-XXXC
Café Blanco	XXX- <b>CB</b> -X-XX-XXXC
Black Lava	XXX- <b>BA</b> -X-XX-XXXC
Smoke	XXX- <b>SM</b> -X-XX-XXXC
Smooth Black	XXX- <b>SB</b> -X-XX-XXXC

To select the body color turn to page 4.

w/ FyreStarter Ignition System †	
Model #:	<b>211-TA-N-XX-H8xC</b>
Price:	<b>\$11,481</b>

w/ FyreStarter Ignition System †	
Model #:	<b>211-LO-N-XX-H8xC</b>
Price:	<b>\$9,853</b>

-Optional vinyl cover: 8145A

-Optional vinyl cover: 8145A

### FIREPLACE VALVES

VALVE	DESCRIPTION	GAS	BTU's
<b>M3</b>	Linear Burner	NG	40k
	Linear Burner	LP	40k
<b>M8</b>	48" Linear Burner	NG	65k
	48" Linear Burner	LP	65k
<b>H8</b>	48" Burner w/ FyreStarter	NG	100k
	48" Burner w/ FyreStarter	LP	100k

M-series valves now include a spark igniter.

\* Cannot accommodate an LP tank inside the unit; selecting Propane may require Tank/End Table and Hose (see page 14).

† FyreStarter = Bluetooth remote control, requires 120 Volt AC Power. Includes **A** and **C** USB ports.

## STEP 4: (Choose Finish)

FINISH COLORS	MODEL #
<b>White Aspen</b>	XXX-XX-X-WA-XXC
<b>Café Blanco</b>	XXX-XX-X-CB-XXC
<b>Black Lava</b>	XXX-XX-X-BA-XXC
<b>Smoke</b>	XXX-XX-X-SM-XXC

ANTIQUÉ FINISHES	MODEL #
<b>Travertine</b>	XXX-XX-X-TR-XXC
<b>Dark Basalt</b>	XXX-XX-X-DB-XXC
<b>Light Basalt</b>	XXX-XX-X-LB-XXC

**Milan Linear Fireplaces Only**  
(In addition to the standard Finish Colors)

- American Fyre Designs™ products are individually handcrafted, the finishes listed are subject to slight texture and color variation.
- American Fyre Designs™ reserves the right to change or discontinue finishes without prior notice. Samples available upon request.
- Contractor's Model Fireplaces are only available in **White (WC)** GFRC finish.

## STEP 5: (Choose Gas Shut Off & Line Location)

GAS SHUT OFF & LINE LOCATION	MODEL #
Key Valve on the <b>RIGHT</b> / Gas Source out the <b>BACK</b>	XXX-XX-X-XX-RBC

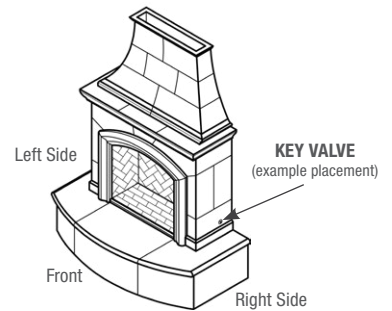

**Note: All Fireplaces are crated for shipment.**

## Fireplace Accessories

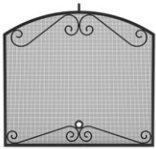

Arched Black Scroll Screen	
Model #:	<b>8250-BL</b>
Price:	<b>\$636</b>
Compatible Fireplaces:	<ul style="list-style-type: none"> <li>Phoenix</li> <li>Grand Phoenix</li> <li>Mariposa</li> </ul>

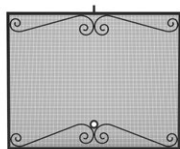

Black Scroll Screen	
Model #:	<b>8255-BL</b>
Price:	<b>\$797</b>
Compatible Fireplaces:	<ul style="list-style-type: none"> <li>Cordova</li> <li>Grand Cordova</li> </ul>

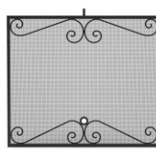

Black Scroll Screen	
Model #:	<b>8253-BL</b>
Price:	<b>\$636</b>
Compatible Fireplaces:	<ul style="list-style-type: none"> <li>Petite Cordova</li> </ul>



GFRC Chimney Rain Vent Cap	
Model #:	<b>8017RV-XX</b>
Price:	<b>\$293</b>
Compatible Fireplaces:	<ul style="list-style-type: none"> <li>Phoenix</li> <li>Grand Phoenix</li> </ul>



GFRC Chimney Rain Vent Cap	
Model #:	<b>8073RV-XX</b>
Price:	<b>\$308</b>
Compatible Fireplaces:	<ul style="list-style-type: none"> <li>Mariposa</li> </ul>



Arched GFRC Protector Plate	
Model #:	<b>8200-XX</b>
Price:	<b>\$416</b>
Compatible Fireplaces:	<ul style="list-style-type: none"> <li>Phoenix</li> <li>Grand Phoenix</li> <li>Mariposa</li> </ul>



GFRC Protector Plate	
Model #:	<b>8210-XX</b>
Price:	<b>\$430</b>
Compatible Fireplaces:	<ul style="list-style-type: none"> <li>Cordova</li> <li>Grand Cordova</li> </ul>



GFRC Protector Plate	
Model #:	<b>8205-XX</b>
Price:	<b>\$416</b>
Compatible Fireplaces:	<ul style="list-style-type: none"> <li>Petite Cordova</li> </ul>



GFRC Chimney Rain Vent Cap	
Model #:	<b>8022RV-XX</b>
Price:	<b>\$319</b>
Compatible Fireplaces:	<ul style="list-style-type: none"> <li>Cordova</li> <li>Grand Cordova</li> </ul>



GFRC Chimney Rain Vent Cap	
Model #:	<b>8025RV-XX</b>
Price:	<b>\$308</b>
Compatible Fireplaces:	<ul style="list-style-type: none"> <li>Petite Cordova</li> </ul>

"-xx" = Insert color code from **STEP 4** above.

## STEP 6: (Choose Media Type & Corresponding Burner)

### Vented & Vent Free Log Sets For Fireplaces

STYLE	MODEL #	16"	18/20"	24"	30"
Charred Oak (Vented)	CHD-xx	\$382 28#	\$431 46#	\$506 62#	\$676 78#



STYLE	MODEL #	16/20"	24"	30"
Charred Frontier Oak (Vent-Free)	CHFR-xx	\$364 35#	\$416 41#	\$517 48#



"-xx" = insert size

For a complete listing of Real Fyre® Vented and Vent-Free log sets see the Real Fyre® Price Lists **L-A3-02124** and **L-F3-02224**.

### Glass, Gems, & Nuggets



See page 12 for packages, colors, and pricing.

Recommendation: One 10 lb package to fill burner pan. If your desire is to fill fireplace at a 2" depth use one 10 lb bag for every 65 sq. inches 25 lbs is recommended for the Manhattan style fireplace.

### Stainless Steel Vented & Vent-Free Burner Systems for Fireplaces

VENTED BURNERS	STYLE	MODEL #	16"	18/20"	24"	30"
G45 Vented Stainless Steel Burner (LOGS)	Standard	G45-xx-SS (Natural gas only)	\$416 25#	\$439 27#	\$470 31#	\$541 37#
	Standard with Assembled Valve	G45-xxNA-SS or G45-xxPA-SS	\$789 27#	\$812 29#	\$843 33#	\$914 39#
G45 Vented Stainless Steel Burner (GLASS/GEMS)	Standard	G45-GL-xx-SS (Natural gas only)	\$394 20#	\$415 22#	\$441 28#	\$510 31#
	Standard with Assembled Valve	G45-GL-xxNA-SS or G45-GL-xxPA-SS	\$767 22#	\$788 24#	\$814 30#	\$883 33#

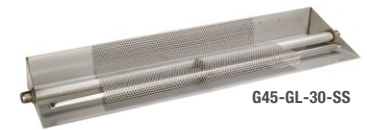

#### VENTED FIREPLACE / BURNER SIZE COMPATIBILITY

Vented Fireplaces	G45 Burner		G22 Burner	
	Match-Lit	w/ Valve	Match-Lit	w/ Valve
022, 882	up to 30"	up to 24"	up to 30"	up to 24"
017, 818, 073, 025, 040, 045	up to 24"	up to 18/20"	up to 24"	up to 18"

VENT-FREE BURNERS	STYLE	MODEL #	16/18"	24/30"
G10 Vent-Free Stainless Steel Burner (LOGS) 16/18" 22-25# 24/30" 26-30#	Manual	G10-xx-SS	\$1,510	\$1,621
	Variable Remote *	G10-xx-15-SS	\$1,983	\$2,094
	Electronic Remote *	G10-xx-01V-SS	\$2,368	\$2,479

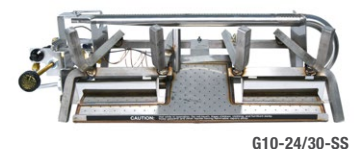

VENT-FREE BURNERS	STYLE	MODEL #	18"	24"	30"
G21 Vent-Free Contemporary Burner (GLASS/GEMS) 20-30#	Remote *	G21-GL-xx-12	\$1,486	\$1,602	\$1,670



#### VENT-FREE FIREPLACE / BURNER SIZE COMPATIBILITY

Vent-free Fireplaces	G10 Burner	G21 Burner
122, 182	up to 24/30" w/ 30" log	up to 30"
117, 118, 173, 125, 140, 145	up to 24/30" w/ 24" log	up to 24"

\* Remote systems include basic Transmitter and Receiver.

"-xx" = insert size

## STEP 1: Choose Product - Chat Height Firetables

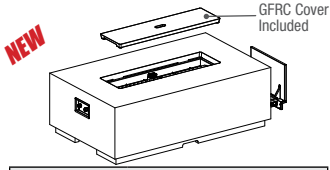

Legend LP Select	
Model #:	<b>585-xx-11-M7PC</b>
Dimensions:	60" w x 36" d x 20" h
Weight (lbs):	420
Price:	<b>\$4,726</b>

-Horizontal LP tank not included  
-Optional vinyl cover: 8152A

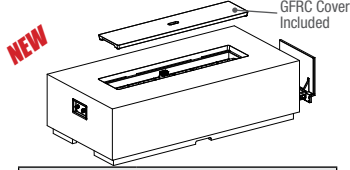

Legend Long LP Select	
Model #:	<b>587-xx-11-M8PC</b>
Dimensions:	72" w x 36" d x 20" h
Weight (lbs):	490
Price:	<b>\$5,759</b>

-Horizontal LP tank not included  
-Optional vinyl cover: 8153A

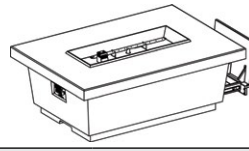

Contempo LP Select	
Model #:	<b>785-xx-11-M4PC</b>
Dimensions:	52" w x 36" d x 18½" h
Weight (lbs):	393
Price:	<b>\$3,760</b>

-Horizontal LP tank not included  
-Optional vinyl cover: 8139A

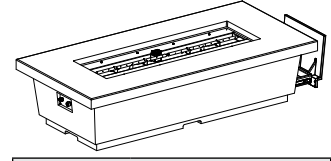

Contempo Long LP Select	
Model #:	<b>788-xx-11-M8PC</b>
Dimensions:	76" w x 36" d x 18½" h
Weight (lbs):	470
Price:	<b>\$5,614</b>

-Horizontal LP tank not included  
-Optional vinyl cover: 8155A

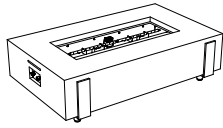

Iron Saddle Firetable *	
Model #:	<b>580-xx-11-M7xC</b>
Dimensions:	60" w x 36" d x 17" h
Weight (lbs):	370
Price:	<b>\$5,129</b>

w/ FyreStarter Ignition System †	
Model #:	<b>580-xx-11-H7xC</b>
Price:	<b>\$7,601</b>

-Optional vinyl cover: 8152A

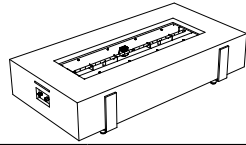

Iron Saddle Long Firetable *	
Model #:	<b>588-xx-11-M8xC</b>
Dimensions:	72" w x 36" d x 17" h
Weight (lbs):	486
Price:	<b>\$6,175</b>

w/ FyreStarter Ignition System †	
Model #:	<b>588-xx-11-H8xC</b>
Price:	<b>\$8,684</b>

-Optional vinyl cover: 8153A

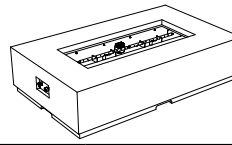

Legend Firetable *	
Model #:	<b>581-xx-11-M7xC</b>
Dimensions:	60" w x 36" d x 14½" h
Weight (lbs):	395
Price:	<b>\$3,976</b>

w/ FyreStarter Ignition System †	
Model #:	<b>581-xx-11-H7xC</b>
Price:	<b>\$6,448</b>

-Optional vinyl cover: 8152A

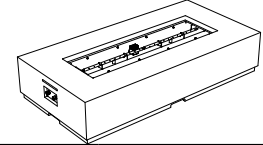

Legend Long Firetable *	
Model #:	<b>589-xx-11-M8xC</b>
Dimensions:	72" w x 36" d x 14½" h
Weight (lbs):	402
Price:	<b>\$5,023</b>

w/ FyreStarter Ignition System †	
Model #:	<b>589-xx-11-H8xC</b>
Price:	<b>\$7,532</b>

-Optional vinyl cover: 8153A

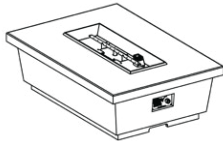

Contempo Rectangle **	
Model #:	<b>783-xx-11-M4xC</b>
Dimensions:	52" w x 36" d x 15½" h
Weight (lbs):	230
Price:	<b>\$3,309</b>

w/ FyreStarter Ignition System †	
Model #:	<b>783-xx-11-H4xC</b>
Price:	<b>\$5,781</b>

-Optional vinyl cover: 8139A

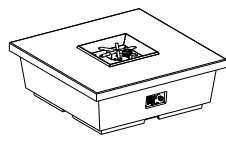

Contempo Square **	
Model #:	<b>784-xx-11-M2xC</b>
Dimensions:	44" w x 44" d x 15½" h
Weight (lbs):	230
Price:	<b>\$3,460</b>

w/ FyreStarter Ignition System †	
Model #:	<b>784-xx-11-H2xC</b>
Price:	<b>\$5,932</b>

-Optional vinyl cover: 8146A

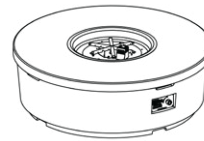

Contempo Round **	
Model #:	<b>782-xx-11-M2xC</b>
Dimensions:	47" dia x 15½" h
Weight (lbs):	200
Price:	<b>\$3,313</b>

w/ FyreStarter Ignition System †	
Model #:	<b>782-xx-11-H2xC</b>
Price:	<b>\$5,785</b>

-Optional vinyl cover: 8143A

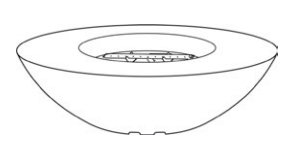

Calais Oval Firetable *	
Model #:	<b>759-xx-11-M4xC</b>
Dimensions:	60" w x 36" d x 18" h
Weight (lbs):	240
Price:	<b>\$4,688</b>

w/ FyreStarter Ignition System †	
Model #:	<b>759-xx-11-H4xC</b>
Price:	<b>\$7,160</b>

-Optional vinyl cover: 8151A



Cosmopolitan Rectangle	
Model #:	<b>635-xx-11-M4xC</b>
Dimensions:	54" w x 36" d x 24" h
Weight (lbs):	220
Price:	<b>\$3,354</b>

w/ FyreStarter Ignition System †	
Model #:	<b>635-xx-11-H4xC</b>
Price:	<b>\$5,826</b>

-Optional vinyl cover: 8138A



Cosmopolitan Square	
Model #:	<b>640-xx-11-M2xC</b>
Dimensions:	36" w x 36" d x 24" h
Weight (lbs):	160
Price:	<b>\$3,034</b>

w/ FyreStarter Ignition System †	
Model #:	<b>640-xx-11-H2xC</b>
Price:	<b>\$5,506</b>

-Optional vinyl cover: 8132A



Cosmopolitan Round	
Model #:	<b>645-xx-11-M2xC</b>
Dimensions:	48" dia x 24" h
Weight (lbs):	210
Price:	<b>\$3,604</b>

w/ FyreStarter Ignition System †	
Model #:	<b>645-xx-11-H2xC</b>
Price:	<b>\$6,076</b>

-Optional vinyl cover: 8135A

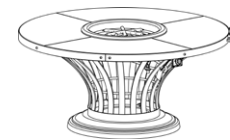

Fiesta Firetable	
Model #:	<b>770-xx-11-M2xC</b>
Dimensions:	54" dia x 25" h
Weight (lbs):	280
Price:	<b>\$3,593</b>

-Optional vinyl cover: 8131A  
-Includes nylon cover for Propane tank

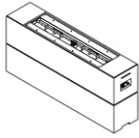

Milan Tall Linear Firetable *	
Model #:	<b>215-xx-11-M8xC</b>
Dimensions:	72" w x 16" d x 32" h
Weight (lbs):	360
Price:	<b>\$4,307</b>

w/ FyreStarter Ignition System †	
Model #:	<b>215-xx-11-H8xC</b>
Price:	<b>\$6,779</b>

-Optional vinyl cover: 8144A

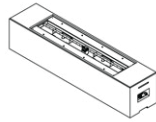

Milan Low Linear Firetable *	
Model #:	<b>216-xx-11-M8xC</b>
Dimensions:	72" w x 16" d x 16" h
Weight (lbs):	215
Price:	<b>\$2,614</b>

w/ FyreStarter Ignition System †	
Model #:	<b>216-xx-11-H8xC</b>
Price:	<b>\$5,086</b>



Voro Firetable	
Model #:	<b>725-xx-11-M2xC</b>
Dimensions:	36" w x 36" d x 24" h
Weight (lbs):	190
Price:	<b>\$3,691</b>

-Optional vinyl cover: 8132A

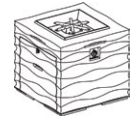

Voro Cube	
Model #:	<b>726-xx-11-M2xC</b>
Dimensions:	25½" w x 25½" d x 22¾" h
Weight (lbs):	170
Price:	<b>\$3,420</b>

## Reclaimed Wood Chat Height Firetables

Reclaimed Wood Firetables feature two (2) table top options, **French Barrel Oak (FO)** and **Silver Pine (SP)**, plus bases with Black Lava (BA) finish. Must select either **French Barrel Oak** (e.g. 635-BA-**FO**-M4xC) or **Silver Pine** (e.g. 635-BA-**SP**-M4xC).

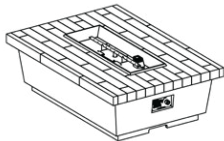

Reclaimed Wood Contempo Rectangle **	
FO Model #:	<b>783-BA-FO-M4xC</b>
SP Model #:	<b>783-BA-SP-M4xC</b>
Dimensions:	54" w x 36" d x 15½" h
Weight (lbs):	230
Price:	<b>\$4,011</b>

w/ FyreStarter Ignition System †	
FO Model #:	<b>783-BA-FO-H4xC</b>
SP Model #:	<b>783-BA-SP-H4xC</b>
Price:	<b>\$6,483</b>

-Optional vinyl cover: 8139A

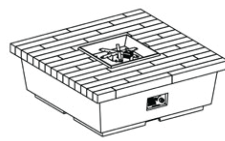

Reclaimed Wood Contempo Square **	
FO Model #:	<b>784-BA-FO-M2xC</b>
SP Model #:	<b>784-BA-SP-M2xC</b>
Dimensions:	44" w x 44" d x 15½" h
Weight (lbs):	230
Price:	<b>\$4,168</b>

w/ FyreStarter Ignition System †	
FO Model #:	<b>784-BA-FO-H2xC</b>
SP Model #:	<b>784-BA-SP-H2xC</b>
Price:	<b>\$6,640</b>

-Optional vinyl cover: 8146A

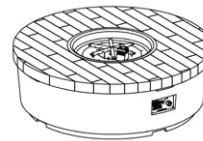

Reclaimed Wood Contempo Round **	
FO Model #:	<b>782-BA-FO-M2xC</b>
SP Model #:	<b>782-BA-SP-M2xC</b>
Dimensions:	47" dia x 15½" h
Weight (lbs):	200
Price:	<b>\$3,850</b>

w/ FyreStarter Ignition System †	
FO Model #:	<b>782-BA-FO-H2xC</b>
SP Model #:	<b>782-BA-SP-H2xC</b>
Price:	<b>\$6,322</b>

-Optional vinyl cover: 8143A

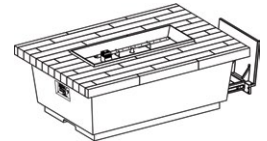

Recl. Wood Contempo LP Select (w/ Drawer to house horizontal LP Tank)	
FO Model #:	<b>785-BA-FO-M4PC</b>
SP Model #:	<b>785-BA-SP-M4PC</b>
Dimensions:	52" w x 36" d x 18½" h
Weight (lbs):	393
Price:	<b>\$4,470</b>

-Horizontal LP tank not included  
-Optional vinyl cover: 8139A



Reclaimed Wood Cosmopolitan Rectangle	
FO Model #:	<b>635-BA-FO-M4xC</b>
SP Model #:	<b>635-BA-SP-M4xC</b>
Dimensions:	54" w x 36" d x 24" h
Weight (lbs):	220
Price:	<b>\$4,136</b>

w/ FyreStarter Ignition System †	
FO Model #:	<b>635-BA-FO-H4xC</b>
SP Model #:	<b>635-BA-SP-H4xC</b>
Price:	<b>\$6,608</b>

-Optional vinyl cover: 8138A

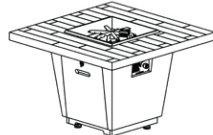

Reclaimed Wood Cosmopolitan Square	
FO Model #:	<b>640-BA-FO-M2xC</b>
SP Model #:	<b>640-BA-SP-M2xC</b>
Dimensions:	36" w x 36" d x 24" h
Weight (lbs):	160
Price:	<b>\$3,577</b>

w/ FyreStarter Ignition System †	
FO Model #:	<b>640-BA-FO-H2xC</b>
SP Model #:	<b>640-BA-SP-H2xC</b>
Price:	<b>\$6,049</b>

-Optional vinyl cover: 8132A



Reclaimed Wood Cosmopolitan Round	
FO Model #:	<b>645-BA-FO-M2xC</b>
SP Model #:	<b>645-BA-SP-M2xC</b>
Dimensions:	48" dia x 24" h
Weight (lbs):	210
Price:	<b>\$4,235</b>

w/ FyreStarter Ignition System †	
FO Model #:	<b>645-BA-FO-H2xC</b>
SP Model #:	<b>645-BA-SP-H2xC</b>
Price:	<b>\$6,707</b>

-Optional vinyl cover: 8135A

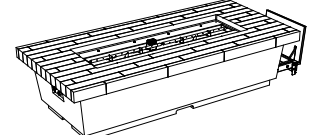

Recl. Wood Contempo LP Select Long (w/ Drawer to house horizontal LP Tank)	
FO Model #:	<b>788-BA-FO-M8PC</b>
SP Model #:	<b>788-BA-SP-M8PC</b>
Dimensions:	76" w x 36" d x 18½" h
Weight (lbs):	573
Price:	<b>\$6,750</b>

-Horizontal LP tank not included  
-Optional vinyl cover: 8155A

### ORDERING NOTES:

1. "-xx" = Insert color from **STEP 2** on page 8.
2. \* Cannot accommodate an LP tank inside the unit; selecting Propane may require Tank/End Table and Hose (see page 14).
3. \*\* All 782, 783, & 784 models for Propane include **5110-26** 10' Gas Hose.
4. † **FyreStarter** = Bluetooth remote control, requires 120 Volt AC Power. Includes A and C USB ports.
5. **Fire Media sold separately!** See pages 12 & 13 for available Fyre Glass, gas logs & lava fyre options.

## Dining Height Firetables

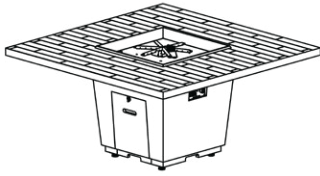

### Reclaimed Wood Cosmopolitan Square Dining Firetable

FO Model #: **642-BA-FO-M6xC**

SP Model #: **642-BA-SP-M6xC**

Dimensions: 60"w x 60"d x 29"h

Weight (lbs): 360

Price: **\$7,446**

### w/ FyreStarter Ignition System †

FO Model #: **642-BA-FO-H6xC**

SP Model #: **642-BA-SP-H6xC**

Price: **\$9,918**

-Optional vinyl cover: 8137A

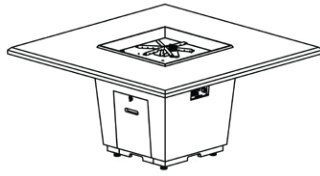

### Cosmopolitan Square Dining Firetable

Model #: **642-xx-11-M6xC**

Dimensions: 60"w x 60"d x 29"h

Weight (lbs): 360

Price: **\$6,483**

### w/ FyreStarter Ignition System †

Model #: **642-xx-11-H6xC**

Price: **\$8,955**

-Optional vinyl cover: 8137A

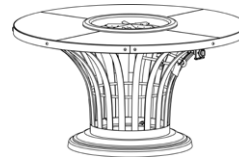

### Fiesta Dining Firetable

Model #: **775-xx-11-M2xC**

Dimensions: 54" dia x 28"h

Weight (lbs): 290

Price: **\$4,011**

-Includes nylon cover for Propane tank

-Optional vinyl cover: 8131A

### FIRETABLE VALVES

VALVE	DESCRIPTION	GAS	BTU's
<b>M2</b>	12" Star Burner	NG	60k
	12" Star Burner	LP	60k
<b>H2</b>	12" Star Burner w/ FyreStarter	NG	65k
	12" Star Burner w/ FyreStarter	LP	65k
<b>M4</b>	24" Linear Burner	NG	60k
	24" Linear Burner	LP	60k
<b>H4</b>	24" Linear Burner w/ FyreStarter	NG	65k
	24" Linear Burner w/ FyreStarter	LP	65k
<b>M6</b>	16" Star Burner	NG	65k
	16" Star Burner	LP	65k
<b>H6</b>	16" Star Burner w/ FyreStarter	NG	75k
	16" Star Burner w/ FyreStarter	LP	75k
<b>M7</b>	36" Linear Burner	NG	65k
	36" Linear Burner	LP	65k
<b>H7</b>	36" Linear Burner w/ FyreStarter	NG	75k
	36" Linear Burner w/ FyreStarter	LP	75k
<b>M8</b>	48" Linear Burner	NG	65k
	48" Linear Burner	LP	65k
<b>H8</b>	48" Linear Burner w/ FyreStarter	NG	100k
	48" Linear Burner w/ FyreStarter	LP	100k

M-series valves now include a **spark igniter**.

### ORDERING NOTES:

1. "-xx" = insert color from **STEP 2**.
2. † **FyreStarter** = Bluetooth remote control, requires 120 Volt AC Power. Includes **A** and **C** USB ports.
3. **Fire Media sold separately!** See pages 12 & 13 for available Fyre Glass, gas logs & lava fyre options.

## STEP 2: Choose Color Option(s)

FINISH COLORS	MODEL #
<b>White Aspen</b>	xxx- <b>WA</b> -xx-xxxC
<b>Café Blanco</b>	xxx- <b>CB</b> -xx-xxxC
<b>Black Lava</b>	xxx- <b>BA</b> -xx-xxxC
<b>Smoke</b>	xxx- <b>SM</b> -xx-xxxC

ANTIQUÉ FINISHES	MODEL #
<b>Travertine</b>	xxx- <b>TR</b> -xx-xxxC
<b>Dark Basalt</b>	xxx- <b>DB</b> -xx-xxxC
<b>Light Basalt</b>	xxx- <b>LB</b> -xx-xxxC

- American Fyre Designs™ products are individually handcrafted, the finishes listed are subject to slight texture and color variation.
- American Fyre Designs™ reserves the right to change or discontinue finishes without prior notice. Samples available upon request.

## STEP 3: Choose Gas Option

GAS OPTIONS	MODEL #
<b>Natural Gas</b>	xxx-xx-xx-xx <b>NC</b>
<b>Propane Gas</b>	xxx-xx-xx-xx <b>PC</b>

**Note: All Firetables, Fire Bowls, & Fire Pits are crated for shipment.**



# Fire Bowls

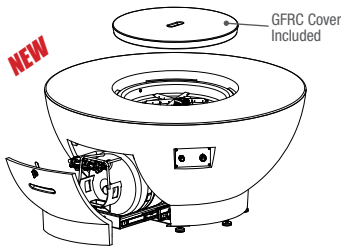

<b>48" Chat Fire Bowl (L.P.)</b>
Model #: <b>738-xx-11-M2PC</b>
Dimensions: 48" dia x 23"h
Weight (lbs): 400
Price: <b>\$4,441</b>

<b>w/ FyreStarter Ignition System †</b>
Model #: <b>738-xx-11-H2PC</b>
Price: <b>\$6,913</b>

-LP units include a tank drawer to accommodate a DOT horizontal tank (tank not included)  
-Optional vinyl cover: 8135A

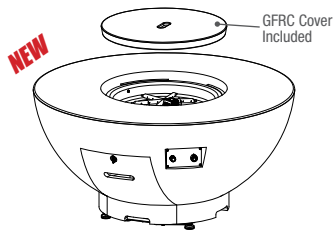

<b>48" Chat Fire Bowl (N.G.)</b>
Model #: <b>738-xx-11-M2NC</b>
Dimensions: 48" dia x 23"h
Weight (lbs): 400
Price: <b>\$3,990</b>

<b>w/ FyreStarter Ignition System †</b>
Model #: <b>738-xx-11-H2NC</b>
Price: <b>\$6,463</b>

-Optional vinyl cover: 8135A

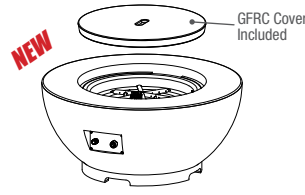

<b>36" Chat Fire Bowl *</b>
Model #: <b>736-xx-11-M2xC</b>
Dimensions: 36" dia x 16½"h
Weight (lbs): 200
Price: <b>\$3,151</b>

<b>w/ FyreStarter Ignition System †</b>
Model #: <b>736-xx-11-H2xC</b>
Price: <b>\$5,551</b>

-Optional vinyl cover: 8140A

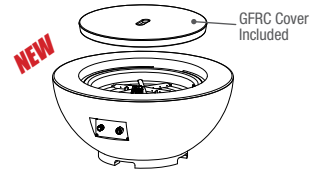

<b>32" Chat Fire Bowl *</b>
Model #: <b>735-xx-11-M2xC</b>
Dimensions: 32" dia x 15"h
Weight (lbs): 170
Price: <b>\$2,969</b>

<b>w/ FyreStarter Ignition System †</b>
Model #: <b>735-xx-11-H2xC</b>
Price: <b>\$5,369</b>

-Optional vinyl cover: 8142A

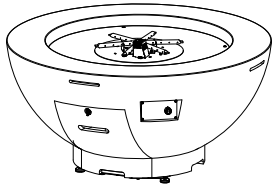

<b>48" Fire Bowl</b>
Model #: <b>731-xx-11-M6xC</b>
Dimensions: 48" dia x 22"h
Weight (lbs): 250
Price: <b>\$3,829</b>

<b>w/ FyreStarter Ignition System †</b>
Model #: <b>731-xx-11-H6xC</b>
Price: <b>\$6,301</b>

-Optional vinyl cover: 8135A

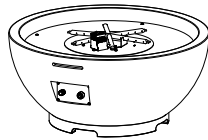

<b>36" Fire Bowl *</b>
Model #: <b>732-xx-11-M6xC</b>
Dimensions: 36" dia x 16"h
Weight (lbs): 154
Price: <b>\$2,718</b>

<b>w/ FyreStarter Ignition System †</b>
Model #: <b>732-xx-11-H6xC</b>
Price: <b>\$5,190</b>

-Optional vinyl cover: 8140A

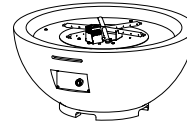

<b>32" Fire Bowl *</b>
Model #: <b>733-xx-11-M6xC</b>
Dimensions: 32" dia x 16"h
Weight (lbs): 109
Price: <b>\$2,549</b>

<b>w/ FyreStarter Ignition System †</b>
Model #: <b>733-xx-11-H6xC</b>
Price: <b>\$5,021</b>

-Optional vinyl cover: 8142A

## FIRE BOWL VALVES

VALVE	DESCRIPTION	GAS	BTU's
M2	12" Star Burner	NG	60k
	12" Star Burner	LP	60k
H2	12" Star Burner w/ FyreStarter	NG	65k
	12" Star Burner w/ FyreStarter	LP	65k
M4	24" Linear Burner	NG	60k
	24" Linear Burner	LP	60k
H4	24" Linear Burner w/ FyreStarter	NG	65k
	24" Linear Burner w/ FyreStarter	LP	65k
M6	16" Star Burner	NG	65k
	16" Star Burner	LP	65k
H6	16" Star Burner w/ FyreStarter	NG	100k
	16" Star Burner w/ FyreStarter	LP	100k

M-series valves now include a spark igniter.

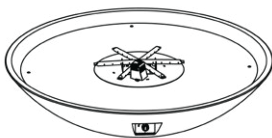

<b>48" Marseille Fire Bowl *</b>
Model #: <b>751-xx-11-M6xC</b>
Dimensions: 48" dia x 10½"h
Weight (lbs): 195
Price: <b>\$2,857</b>

<b>w/ FyreStarter Ignition System †</b>
Model #: <b>751-xx-11-H6xC</b>
Price: <b>\$5,329</b>

<b>with Water Spout</b>
Model #: <b>751-xx-80-M6xC</b>
Price: <b>\$3,355</b>

-Optional vinyl cover: 8143A

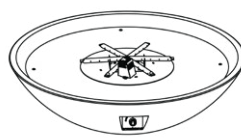

<b>40" Marseille Fire Bowl *</b>
Model #: <b>752-xx-11-M6xC</b>
Dimensions: 40" dia x 10½"h
Weight (lbs): 150
Price: <b>\$2,439</b>

<b>w/ FyreStarter Ignition System †</b>
Model #: <b>752-xx-11-H6xC</b>
Price: <b>\$4,911</b>

<b>with Water Spout</b>
Model #: <b>752-xx-80-M6xC</b>
Price: <b>\$2,937</b>

-Optional vinyl cover: 8140A

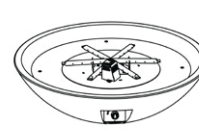

<b>32" Marseille Fire Bowl *</b>
Model #: <b>753-xx-11-M6xC</b>
Dimensions: 32" dia x 8½"h
Weight (lbs): 90
Price: <b>\$2,159</b>

<b>with Water Spout</b>
Model #: <b>753-xx-80-M6xC</b>
Price: <b>\$2,659</b>

-Optional vinyl cover: 8142A

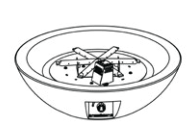

<b>24" Marseille Fire Bowl *</b>
Model #: <b>755-xx-11-M2xC</b>
Dimensions: 24" dia x 6½"h
Weight (lbs): 45
Price: <b>\$1,879</b>

Note: Bowls with Water Spouts are **not available** with FyreStarter ignition.

## ORDERING NOTES:

1. "-xx" = Insert color from STEP 2 on page 11.
2. \* Cannot accommodate an LP tank inside the unit; selecting Propane may require Tank/End Table and Hose (see page 14).
3. † FyreStarter = Bluetooth remote control, requires 120 Volt AC Power. Includes A and C USB ports.
4. Fire Media sold separately! See pages 12 & 13 for available Fyre Glass, gas logs & lava fyre options.

## Fire Bowls

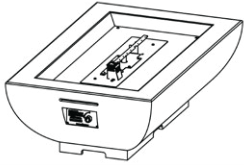

<b>Bordeaux Rectangle Fire Bowl*</b>	
Model #:	<b>435-xx-11-M4xC</b>
Dimensions:	50" w x 30" d x 16¼" h
Weight (lbs):	205
Price:	<b>\$4,107</b>

<b>w/ FyreStarter Ignition System †</b>	
Model #:	<b>435-xx-11-H4xC</b>
Price:	<b>\$6,579</b>

-Optional vinyl cover: 8148A



<b>Bordeaux Square Fire Bowl*</b>	
Model #:	<b>430-xx-11-M6xC</b>
Dimensions:	36" w x 36" d x 15¼" h
Weight (lbs):	180
Price:	<b>\$3,409</b>

<b>w/ FyreStarter Ignition System †</b>	
Model #:	<b>430-xx-11-H6xC</b>
Price:	<b>\$5,881</b>

-Optional vinyl cover: 8132A



<b>Bordeaux Petite Square Fire Bowl*</b>	
Model #:	<b>431-xx-11-M6xC</b>
Dimensions:	30" w x 30" d x 12¼" h
Weight (lbs):	140
Price:	<b>\$3,128</b>

-Optional vinyl cover: 8132A



<b>Reclaimed Wood Bordeaux Square Fire Bowl*</b>	
FO Model #:	<b>430-FO-FO-M6xC</b>
SP Model #:	<b>430-SP-SP-M6xC</b>
Dimensions:	36" w x 36" d x 15¼" h
Weight (lbs):	180
Price:	<b>\$4,107</b>

<b>w/ FyreStarter Ignition System †</b>	
FO Model #:	<b>430-FO-FO-H6xC</b>
SP Model #:	<b>430-SP-SP-H6xC</b>
Price:	<b>\$6,579</b>

-Optional vinyl cover: 8132A

## Fire Pits

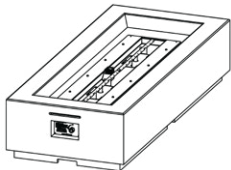

<b>Louvre Long Rectangle Fire Pit*</b>	
Model #:	<b>688-xx-11-M8xC</b>
Dimensions:	72¼" w x 30¼" d x 15¼" h
Weight (lbs):	260
Price:	<b>\$4,684</b>

<b>w/ FyreStarter Ignition System †</b>	
Model #:	<b>688-xx-11-H8xC</b>
Price:	<b>\$7,156</b>

-Optional vinyl cover: 8149A

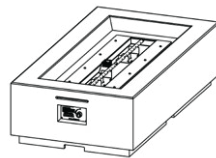

<b>Louvre Rectangle Fire Pit*</b>	
Model #:	<b>689-xx-11-M7xC</b>
Dimensions:	56¼" w x 30¼" d x 15¼" h
Weight (lbs):	215
Price:	<b>\$4,110</b>

<b>w/ FyreStarter Ignition System †</b>	
Model #:	<b>689-xx-11-H7xC</b>
Price:	<b>\$6,582</b>

-Optional vinyl cover: 8150A

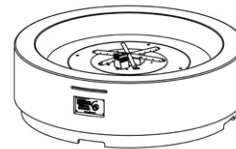

<b>Louvre Round Fire Pit*</b>	
Model #:	<b>686-xx-11-M6xC</b>
Dimensions:	48" dia x 15¼" h
Weight (lbs):	220
Price:	<b>\$4,110</b>

<b>w/ FyreStarter Ignition System †</b>	
Model #:	<b>686-xx-11-H6xC</b>
Price:	<b>\$6,582</b>

-Optional vinyl cover: 8143A

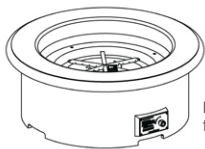

Recessed for field cladding

<b>Contractor's Model Fire Pit*</b>	
Model #:	<b>685-xx-11-M6xC</b>
Dimensions:	39" dia x 14½" h
Weight (lbs):	190
Price:	<b>\$2,951</b>

<b>w/ FyreStarter Ignition System †</b>	
Model #:	<b>685-xx-11-H6xC</b>
Price:	<b>\$5,423</b>

-Optional vinyl cover: 8140A

### FIRE PIT VALVES

VALVE	DESCRIPTION	GAS	BTU's
<b>M6</b>	16" Star Burner	NG	65k
	16" Star Burner	LP	65k
<b>H6</b>	16" Star Burner w/ FyreStarter	NG	100k
	16" Star Burner w/ FyreStarter	LP	100k
<b>M7</b>	36" Linear Burner	NG	65k
	36" Linear Burner	LP	65k
<b>H7</b>	36" Linear Burner w/ FyreStarter	NG	75k
	36" Linear Burner w/ FyreStarter	LP	75k
<b>M8</b>	48" Linear Burner	NG	65k
	48" Linear Burner	LP	65k
<b>H8</b>	48" Linear Burner w/ FyreStarter	NG	100k
	48" Linear Burner w/ FyreStarter	LP	100k

M-series valves now include a **spark igniter**.

### ORDERING NOTES:

1. "-xx" = Insert color from **STEP 2** on page 11.
2. \* Cannot accommodate an LP tank inside the unit; selecting Propane may require Tank/End Table and Hose (see page 14).
3. † **FyreStarter** = Bluetooth remote control, requires 120 Volt AC Power. Includes **A** and **C** USB ports.
4. **Fire Media sold separately!** See pages 12 & 13 for available Fyre Glass, gas logs & lava fyre options.

## Fire Urns

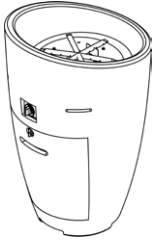

Eclipse Fire Urn	
Model #:	<b>520-xx-11-M2xC</b>
Dimensions:	23" dia x 37½"h
Weight (lbs):	170
Price:	<b>\$2,585</b>

-Optional vinyl cover: 8141A

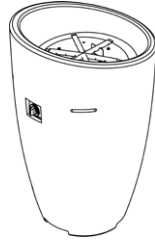

Eclipse Fire Urn* (without access door)	
Model #:	<b>520-xx-10-M2NC</b>
Dimensions:	23" dia x 37½"h
Weight (lbs):	170
Price:	<b>\$2,450</b>

-Natural Gas only  
-Optional vinyl cover: 8141A



Wave Fire Urn	
Model #:	<b>530-xx-11-M2xC</b>
Dimensions:	20" dia x 37½"h
Weight (lbs):	150
Price:	<b>\$2,585</b>

-Optional vinyl cover: 8141A

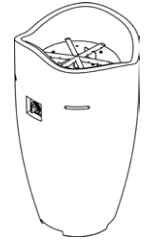

Wave Fire Urn* (without access door)	
Model #:	<b>530-xx-10-M2NC</b>
Dimensions:	20" dia x 37½"h
Weight (lbs):	150
Price:	<b>\$2,450</b>

-Natural Gas only  
-Optional vinyl cover: 8141A

## Lanterns

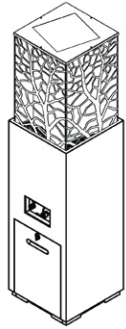

Magnolia Lantern#	
Model #:	<b>716-xx-11-M1xC</b>
Dimensions:	16"w x 16"d x 66"h
Weight (lbs):	160
Price:	<b>\$2,843</b>

w/ FyreStarter Ignition System †	
Model #:	<b>716-xx-11-H1xC</b>
Price:	<b>\$5,315</b>

-Optional vinyl cover: 8134A

### LANTERN VALVES

VALVE	DESCRIPTION	GAS	BTU's
<b>M1</b>	Lantern Burner	NG	25k
	Lantern Burner	LP	23k
<b>H1</b>	Lantern Burner w/ FyreStarter	NG	28k
	Lantern Burner w/ FyreStarter	LP	27k

M-series valves now include a spark igniter.

† Magnolia Lanterns may not use Reflective Fyre Glass or Diamond Nuggets.  
See Page 12 for available Glass Media.

### FIRE URN VALVES

VALVE	DESCRIPTION	GAS	BTU's
<b>M2</b>	12" Star Burner	NG	60k
	12" Star Burner	LP	60k

M-series valves now include a spark igniter.

## STEP 2: Choose Color Option(s)

FINISH COLORS	MODEL #
<b>White Aspen</b>	xxx-WA-xx-xxxC
<b>Café Blanco</b>	xxx-CB-xx-xxxC
<b>Black Lava</b>	xxx-BA-xx-xxxC
<b>Smoke</b>	xxx-SM-xx-xxxC

ANTIQUE FINISHES	MODEL #
<b>Travertine</b>	xxx-TR-xx-xxxC
<b>Dark Basalt</b>	xxx-DB-xx-xxxC
<b>Light Basalt</b>	xxx-LB-xx-xxxC

RECLAIMED WOOD FINISHES	MODEL #
<b>French Barrel Oak</b>	xxx-FO-FO-xxxC
<b>Silver Pine</b>	xxx-SP-SP-xxxC

"Reclaimed Wood" finish options are only available for the Bordeaux Square Fire Bowl (430 model).

- American Fyre Designs™ products are individually handcrafted, the finishes listed are subject to slight texture and color variation.
- American Fyre Designs™ reserves the right to change or discontinue finishes without prior notice. Samples available upon request.

## STEP 3: Choose Gas Option

GAS OPTIONS	MODEL #
<b>Natural Gas</b>	xxx-xx-xx-xxNC
<b>Propane Gas</b>	xxx-xx-xx-xxPC

**Note: All Firetables, Fire Bowls, & Fire Pits are crated for shipment.**

## Fyre Glass



AVAILABLE COLORS	10 lb. Package \$103	40 lb. Bucket \$414
Azuria	GL-10-F	GL-40-F
Black	GL-10-B	GL-40-B
Bronze	GL-10-Z	GL-40-Z
Caribbean Blue	GL-10-N	GL-40-N
Clear	GL-10-C	GL-40-C
Emerald	GL-10-E	GL-40-E
Star Fyre	GL-10-W	GL-40-W

## Reflective Fyre Glass

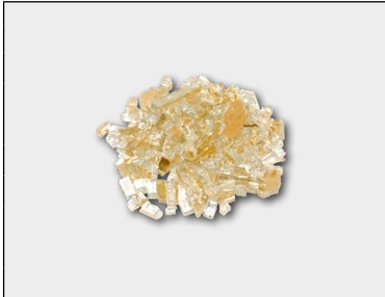

AVAILABLE COLORS	10 lb. Package \$114	40 lb. Bucket \$451
Azuria Reflective	GL-10-FR	GL-40-FR
Black Reflective	GL-10-BR	GL-40-BR
Bronze Reflective	GL-10-ZR	GL-40-ZR
Caribbean Blue Reflective	GL-10-NR	GL-40-NR
Copper Reflective	GL-10-QR	GL-40-QR
Emerald Reflective	GL-10-ER	GL-40-ER
Gold Reflective	GL-10-HR	GL-40-HR
Champagne Reflective	GL-10-CR	GL-40-CR

## Fyre Gems

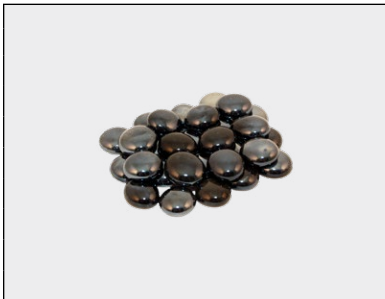

AVAILABLE COLORS	10 lb. Package \$87	40 lb. Bucket \$343
Black Pearl	GLG-10-J	GLG-40-J
Blue Topaz	GLG-10-T	GLG-40-T
Champagne	GLG-10-D	GLG-40-D
Deep Amber	GLG-10-A	GLG-40-A
Emerald	GLG-10-E	GLG-40-E
Glacier	GLG-10-C	GLG-40-C
Sapphire	GLG-10-S	GLG-40-S
Ruby	GLG-10-RY	GLG-40-RY

## Diamond Nuggets



AVAILABLE COLORS	10 lb. Package \$99	40 lb. Bucket \$398
Clear	GLD-10-C	GLD-40-C
Steel Blue	GLD-10-SB	GLD-40-SB
Rosé	GLD-10-R	GLD-40-R
Emerald	GLD-10-E	GLD-40-E
Pacific Blue	GLD-10-PB	GLD-40-PB
Deep Black	GLD-10-DB	GLD-40-DB

## Recommended Amount of Glass Media to Purchase (in addition to the included base media) \*

ITEM DESCRIPTION	AMT.
Magnolia Lantern (716) (NOTE: Magnolia Lanterns <b>may not</b> use Reflective Glass or Diamond Nuggets)	6 lbs
Cosmo Rect. Firetable (635), Cosmo Square Firetable (640), Voro (725), Voro Cube (726), Contempo Rect. Firetable (783), Contempo Square Firetable (784), Contempo LP Select (785)	10 lbs
Legend LP Select (585)	15 lbs
Cosmo Round Firetable (645), Fiesta Firetable (770), Fiesta Dining Firetable (775), Contempo Round Firetable (782), 24" Marseille Fire Bowl (755), Wave Urn (530), 32" Chat Fire Bowl (735), 36" Chat Fire Bowl (736), 48" Chat Fire Bowl (738)	20 lbs
Iron Saddle Firetable (580), Legend Firetable (581), Legend Long LP Select (587)	25 lbs
Contractor's Model Fire Pit (685) (low setting), Bordeaux Petite Square Fire Bowl (431), 32" Fire Bowl (733), Manhattan Fireplace (082), Eclipse Urn (520)	30 lbs
Milan Tall Linear Firetable (215), Milan Low Linear Firetable (216), Milan Tall Linear Fireplace (211-TA), Milan Low Linear Fireplace (211-L0)	35 lbs
Cosmo Sq. Dining Firetable (642), Bordeaux Square Fire Bowl (430), 32" Marseille Fire Bowl (753), Calais Oval Firetable (759), Iron Saddle Long Firetable (588), Legend Long Firetable (589), Contempo Long LP Select (788)	40 lbs
Louvre Rectangle Fire Pit (689), Bordeaux Rectangle Fire Bowl (435), 36" Fire Bowl (732)	50 lbs
Louvre Long Rectangle Fire Pit (688), Contractor's Model Fire Pit (685) (high setting)	60 lbs
Louvre Round Fire Pit (686), 48" Fire Bowl (731)	70 lbs
40" Marseille Fire Bowl (752)	80 lbs
48" Marseille Fire Bowl (751)	110 lbs

\*All AFD firetables, fire pits, and fire bowls along with Manhattan fireplace **include a 10# or 5# bag of lava granules (LF-10 or LF-5)** to serve as base media. Not included with Magnolia Lantern, Eclipse, or Wave fire urns.

## Fyre Spheres

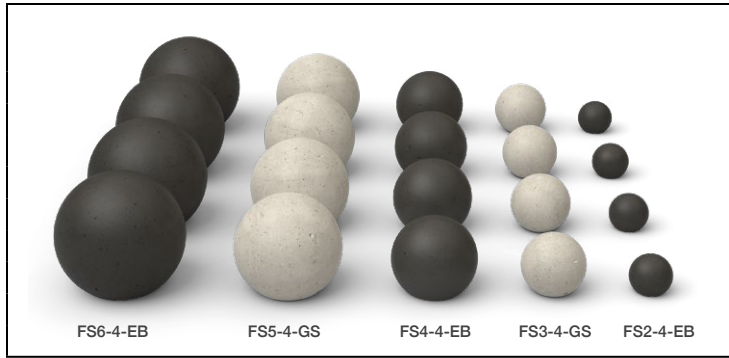

DESCRIPTION	COLOR	MODEL #	PRICE
2" Fyre Spheres (4 in a box)	Epic Black	FS2-4-EB	\$40
	Graystone	FS2-4-GS	37
3" Fyre Spheres (4 in a box)	Epic Black	FS3-4-EB	50
	Graystone	FS3-4-GS	46
4" Fyre Spheres (4 in a box)	Epic Black	FS4-4-EB	58
	Graystone	FS4-4-GS	53
5" Fyre Spheres (4 in a box)	Epic Black	FS5-4-EB	87
	Graystone	FS5-4-GS	79
6" Fyre Spheres (4 in a box)	Epic Black	FS6-4-EB	135
	Graystone	FS6-4-GS	122

## Gas Log Sets, Stones & Lava



GAS LOGS, STONES & LAVA	MODEL #	PRICE
Back Country Oak †	BCO-27	\$646
Desert Sage †	DS-27	646
Prairie Oak †	PRO-27	609
Campfyre Logs, Wood Chips †	OCL-34	397
Beachwood Logs, Stones †	OCBW-34	430
Desert Sage Branches	BDS-2	125
Charred Branches	BDC-4	124
36-Pc. Wood Chunks	WCD-36	317
10-Pc. River Rock Fyre Stones	STN-10	142
20-Pc. River Rock Fyre Stones	STN-20	332
140-Pc. Creekstones, Greige	CSTN-20-G	355
140-Pc. Creekstones, Cloud	CSTN-20-C	355
140-Pc. Creekstones, Mixed (Greige & Cloud)	CSTN-20-CG	355
140-Pc. Creekstones, Black	CSTN-20-B	410
Lava Stones (35 lbs)	LVS-35	110
Lava Stones (15 lbs)	LVS-15	68
Lava Fyre Coals (10 lbs)	LFC-10	47
Lava Fyre Granules (10 lbs)	LF-10	40
Lava Fyre Granules (5 lbs)	LF-5	25

†Lava needs to be ordered separately

† Log sets pictured with recommended Lava Granules or Lava Coals. Lava Granules & Lava Coals are not included with log set and must be ordered separately. Additional River Rock and accessories available. See Peterson Real Fyre® Price List# L-A3-02124

### Recommended Amount of Lava Media (Granules & Coals) to Purchase (in addition to the included base media) \*

ITEM DESCRIPTION	AMT.
Cosmopolitan Rectangle Firetable (635), Cosmopolitan Square Firetable (640), Cosmopolitan Round Firetable (645), Voro Firetable (725), Voro Cube (726), Contempo Round Firetable (782), Contempo Rectangle Firetable (783), Contempo Square Firetable (784), Contempo LP Select (785), 24" Marseille Fire Bowl (755), Iron Saddle Firetable (580), Legend Firetable (581), Iron Saddle Firetable (580), Legend LP Select (585), 32" Chat Fire Bowl (735), 36" Chat Fire Bowl (736), 48" Chat Fire Bowl (738)	10 lbs
Fiesta Firetable (770), Fiesta Dining Firetable (775), Wave Urn (530), Bordeaux Petite Square Fire Bowl (431), Manhattan Fireplace (082), Legend Long LP Select (587)	15 lbs
Eclipse Urn (520), Contractor's Model Fire Pit (685) (low setting), Bordeaux Square Fire Bowl (430), 32" Marseille Fire Bowl (753), Milan Tall Linear Firetable (215), Milan Low Linear Firetable (216), Calais Oval Firetable (759), Milan Tall Linear Fireplace (211-TA), Milan Low Linear Fireplace (211-L0)	20 lbs
Cosmopolitan Square Dining Firetable (642), 32" Fire Bowl (733), Iron Saddle Long Firetable (588), Legend Long Firetable (589), Contempo LP Select Long (788)	25 lbs
Louvre Rectangle Fire Pit (689), Contractor's Model Fire Pit (685) (high setting), Bordeaux Rectangle Fire Bowl (435), 36" Fire Bowl (732)	30 lbs
48" Fire Bowl (731)	35 lbs
Louvre Round Fire Pit (686), Louvre Long Rectangle Fire Pit (688), 40" Marseille Fire Bowl (752)	40 lbs
48" Marseille Fire Bowl (751)	50 lbs

\*All AFD firetables, fire pits, and fire bowls along with Manhattan fireplace include a 10# or 5# bag of lava granules (LF-10 or LF-5) to serve as base media. Not included with Magnolia Lantern, Eclipse, or Wave fire urns.

Lava Media may not be used with Lanterns.

## Vinyl Protective Covers

PRODUCT DESCRIPTION - (Model Prefix)	MODEL #	PRICE
<b>FIREPLACES</b>		
<b>Milan Low Linear</b> - (211-L0)	8145A	\$185
<b>Milan Tall Linear</b> - (211-TA)	8145A	\$185
<b>FIRETABLES</b>		
<b>Fiesta</b> - (770)	8131A	\$102
<b>Iron Saddle</b> - (580)	8152A	\$128
<b>Iron Saddle Long</b> - (588)	8153A	\$196
<b>Legend</b> - (581 & 585)	8152A	\$128
<b>Legend Long</b> - (589 & 585)	8153A	\$196
<b>Contempo Rectangle</b> - (783)	8139A	\$125
<b>Contempo Square</b> - (784)	8146A	\$112
<b>Contempo Round</b> - (782)	8143A	\$111
<b>Contempo LP Select</b> - (785)	8139A	\$125
<b>Contempo LP Select Long</b> - (788)	8155A	\$202
<b>Cosmopolitan Rectangle</b> - (635)	8138A	\$143
<b>Cosmopolitan Square</b> - (640)	8132A	\$81
<b>Cosmopolitan Round</b> - (645)	8135A	\$144
<b>Calais Oval</b> - (759)	8151A	\$126
<b>Voro</b> - (725)	8132A	\$81
<b>Milan Tall Linear</b> - (215)	8144A	\$176
<b>Cosmopolitan Square Dining</b> - (642)	8137A	\$210
<b>Fiesta Dining</b> - (775)	8131A	\$102
<b>Long Fire Pits</b> - (588), (589)	8153A	\$196
<b>FIRE PITS</b>		
<b>48" Louvre</b> - (686)	8143A	\$111
<b>Louvre Long Rectangle</b> - (688)	8149A	\$151
<b>Louvre Rectangle</b> - (689)	8150A	\$131
<b>Fire Pits</b> - (685)	8140A	\$111
<b>FIRE BOWLS</b>		
<b>48" Fire Bowl</b> - (731)	8135A	\$144
<b>Fire Bowls</b> - (732, 752)	8140A	\$111
<b>Fire Bowls</b> - (733, 753)	8142A	\$88
<b>48" Marseille</b> - (751)	8143A	\$111
<b>Bordeaux Rectangle</b> - (435)	8148A	\$126
<b>Bordeaux Square</b> - (430, 431)	8132A	\$81
<b>FIRE URNS &amp; LANTERNS</b>		
<b>Eclipse</b> - (520)	8141A	\$82
<b>Wave</b> - (530)	8141A	\$82
<b>Magnolia</b> - (716)	8134A	\$111
<b>Propane Tank Nylon Cover</b>	5110-13-20	\$62

## GFRC Covers

RECLAIMED WOOD

PRODUCT DESCRIPTION - (Model Prefix)	WT. (lbs)	MODEL #	PRICE	MODEL #	PRICE
<b>FIRETABLES</b>					
<b>Fiesta</b> - (770)	16	8100-XX	\$178		
<b>Iron Saddle</b> - (580)	39	8115-XX	\$383	N/A	
<b>Legend</b> - (581)	39	8115-XX	\$383		
<b>Contempo Rectangle</b> - (783)	25	8110-XX	\$210	8110-FO (-SP)	\$287
<b>Contempo Square</b> - (784)	18	8120-XX	\$178	8120-FO (-SP)	\$236
<b>Contempo Round</b> - (782)	16	8100-XX	\$178	8100-FO (-SP)	\$236
<b>Contempo LP Select</b> - (785)	25	8110-XX	\$210	8110-FO (-SP)	\$287
<b>Cosmopolitan Rectangle</b> - (635)	25	8110-XX	\$210	8110-FO (-SP)	\$287
<b>Cosmopolitan Square</b> - (640)	18	8120-XX	\$178	8120-FO (-SP)	\$236
<b>Cosmopolitan Round</b> - (645)	16	8100-XX	\$178	8100-FO (-SP)	\$236
<b>Voro</b> - (725, 726)	18	8120-XX	\$178	N/A	
<b>Cosmo Square Dining</b> - (642)	45	8123-XX	\$265	8123-FO (-SP)	\$315
<b>Fiesta Dining</b> - (775)	16	8100-XX	\$178	N/A	

"xx" = Insert color from Pg. 13 colors

## Stainless Steel Covers

PRODUCT DESCRIPTION - (Model Prefix)	WT. (lbs)	MODEL #	PRICE
<b>FIRETABLES</b>			
<b>Iron Saddle Long</b> - (588)	24	8116-SS	\$292
<b>Legend Long</b> - (589)	24	8116-SS	\$292
<b>Contempo LP Select Long</b> - (788)	24	8116-SS	\$292



## Tank/End Tables & Extension Hose

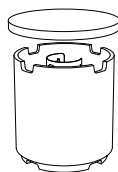
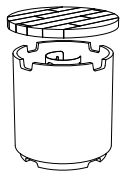

Reclaimed Wood Contempo Tank/End Table *
FO Model #: <b>8510-BA-FO</b>
SP Model #: <b>8510-BA-SP</b>
Dimensions: 20¾" dia x 19¼"h
Price: <b>\$478</b>

Contempo Tank/End Table *
Model #: <b>8510-xx</b>
Dimensions: 20¾" dia x 19¼"h
Price: <b>\$400</b>

10 ft. LP Extension Hose w/ Elbow Fitting
Model #: <b>5110-26</b>
Dimensions: 10 ft. long
Price: <b>\$107</b>

\* Propane tank and hose not included.

"-xx" = insert color from Pg. 13 colors.

## Tempered Glass Wind Guards

DESCRIPTION	SIZE	COMPATIBLE MODELS	MODEL #	PRICE
Square Wind Guard	19¼" w x 19¼" d x 6¾" h	640, 725, 784	<b>8202-WG</b>	<b>\$392</b>
Rectangular Wind Guard	35" w x 14½" d x 6¾" h	635, 783, 785	<b>8204-WG</b>	<b>459</b>
Round Wind Guard	26" dia x 6¾" h	All Round Firetables	<b>8208-WG</b>	<b>501</b>
Large Square Wind Guard	28" w x 28" d x 6¾" h	642	<b>8210-WG</b>	<b>567</b>
Milan Wind Guard	51½" w x 14½" d x 6¾" h	215, 216, 587	<b>8212-WG</b>	<b>639</b>
Large Rect. Wind Guard	43" w x 19¼" d x 6¾" h	580, 581	<b>8211-WG</b>	<b>602</b>
Large Rect. Wind Guard	43" w x 14½" d x 6¾" h	585	<b>8213-WG</b>	<b>570</b>
Large Rect. Wind Guard	51½" w x 19¼" d x 6¾" h	588, 589, 788	<b>8218-WG</b>	<b>669</b>

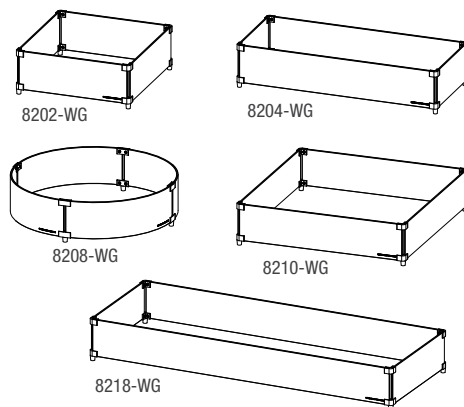

## Gas Conversion Kits

Model Prefix	FIRESTARTER VALVE		MANUAL FLAME SENSING CONTROL VALVE		AWEIS VALVE (Pre 2022)		PUSH-TO-TURN (Pre 2021)		KEY VALVE (Pre 2021)	
	LP to NG	NG to LP	LP to NG	NG to LP	LP to NG	NG to LP	LP to NG	NG to LP	LP to NG	NG to LP
<b>FIRETABLES</b>										
725, 726	N/A		MCK-01-NAT <b>\$68</b>	MCK-01-LP <b>\$75</b>	N/A		CK-11-NAT <b>\$64</b>	CK-13-LP <b>\$64</b>	CK-20-NAT <b>\$64</b>	CK-22-LP <b>\$64</b>
770, 775	N/A		MCK-01-NAT <b>\$68</b>	MCK-10-LP <b>\$75</b>	N/A		CK-11-NAT <b>\$64</b>	CK-13-LP <b>\$64</b>	CK-20-NAT <b>\$64</b>	CK-22-LP <b>\$64</b>
783, 784, 782	HCK-02-NAT <b>\$176</b>	HCK-02-LP <b>\$176</b>	MCK-02-NAT <b>\$34</b>	MCK-02-LP <b>\$34</b>	CK-81-NAT <b>\$25</b>	CK-85-LP <b>\$33</b>	CK-12-NAT <b>\$16</b>	CK-15-LP <b>\$25</b>	CK-21-NAT <b>\$16</b>	CK-24-LP <b>\$25</b>
785	N/A		MCK-02-NAT <b>\$34</b>	MCK-02-LP <b>\$34</b>	N/A		N/A		N/A	
759	HCK-02-NAT <b>\$176</b>	HCK-02-LP <b>\$176</b>	MCK-02-NAT <b>\$34</b>	MCK-02-LP <b>\$34</b>	N/A		CK-12-NAT <b>\$16</b>	CK-15-LP <b>\$25</b>	CK-21-NAT <b>\$16</b>	CK-24-LP <b>\$25</b>
640, 645	HCK-01-NAT <b>\$223</b>	HCK-01-LP <b>\$216</b>	MCK-01-NAT <b>\$68</b>	MCK-01-LP <b>\$75</b>	CK-79-NAT <b>\$84</b>	CK-83-LP <b>\$68</b>	CK-11-NAT <b>\$64</b>	CK-13-LP <b>\$64</b>	CK-20-NAT <b>\$64</b>	CK-22-LP <b>\$64</b>
635	HCK-01-NAT <b>\$223</b>	HCK-09-LP <b>\$205</b>	MCK-01-NAT <b>\$68</b>	MCK-09-LP <b>\$68</b>	CK-79-NAT <b>\$84</b>	CK-82-LP <b>\$68</b>	CK-11-NAT <b>\$64</b>	CK-14-LP <b>\$64</b>	CK-20-NAT <b>\$64</b>	CK-23-LP <b>\$64</b>
642	HCK-08-NAT <b>\$216</b>	HCK-08-LP <b>\$201</b>	MCK-03-NAT <b>\$68</b>	MCK-03-LP <b>\$75</b>	CK-80-NAT <b>\$84</b>	CK-84-LP <b>\$107</b>	CK-51-NAT <b>\$64</b>	CK-53-LP <b>\$64</b>	CK-55-NAT <b>\$64</b>	CK-57-LP <b>\$64</b>
215, 216	HCK-07-NAT <b>\$201</b>	HCK-07-LP <b>\$201</b>	MCK-06-NAT <b>\$55</b>	MCK-06-LP <b>\$55</b>	CK-76-NAT <b>\$33</b>	CK-78-LP <b>\$49</b>	N/A		N/A	
580, 581	HCK-06-NAT <b>\$201</b>	HCK-06-LP <b>\$205</b>	MCK-06-NAT <b>\$55</b>	MCK-06-LP <b>\$55</b>	N/A		N/A		N/A	
<b>FIRE PITS</b>										
685, 686	HCK-04-NAT <b>\$176</b>	HCK-04-LP <b>\$176</b>	MCK-04-NAT <b>\$34</b>	MCK-04-LP <b>\$34</b>	CK-72-NAT <b>\$25</b>	CK-74-LP <b>\$33</b>	CK-52-NAT <b>\$16</b>	CK-54-LP <b>\$25</b>	CK-56-NAT <b>\$16</b>	CK-58-LP <b>\$25</b>
689	HCK-06-NAT <b>\$201</b>	HCK-06-LP <b>\$205</b>	MCK-06-NAT <b>\$55</b>	MCK-06-LP <b>\$55</b>	CK-95-NAT <b>\$64</b>	CK-96-LP <b>\$64</b>	CK-87-NAT <b>\$16</b>	CK-88-LP <b>\$16</b>	CK-89-NAT <b>\$25</b>	CK-90-LP <b>\$16</b>
688	HCK-07-NAT <b>\$201</b>	HCK-07-LP <b>\$201</b>	MCK-06-NAT <b>\$55</b>	MCK-06-LP <b>\$55</b>	CK-76-NAT <b>\$33</b>	CK-78-LP <b>\$49</b>	CK-91-NAT <b>\$84</b>	CK-92-LP <b>\$49</b>	CK-93-NAT <b>\$64</b>	CK-94-LP <b>\$49</b>
<b>FIRE BOWLS</b>										
753, 431, 755	N/A		MCK-04-NAT <b>\$34</b>	MCK-04-LP <b>\$34</b>	N/A		CK-52-NAT <b>\$16</b>	CK-54-LP <b>\$25</b>	CK-56-NAT <b>\$16</b>	CK-58-LP <b>\$25</b>
732, 733, 751, 752	HCK-04-NAT <b>\$176</b>	HCK-04-LP <b>\$176</b>	MCK-04-NAT <b>\$34</b>	MCK-04-LP <b>\$34</b>	CK-72-NAT <b>\$25</b>	CK-74-LP <b>\$33</b>	CK-52-NAT <b>\$16</b>	CK-54-LP <b>\$25</b>	CK-56-NAT <b>\$16</b>	CK-58-LP <b>\$25</b>
430	HCK-04-NAT <b>\$176</b>	HCK-04-LP <b>\$176</b>	MCK-04-NAT <b>\$34</b>	MCK-04-LP <b>\$34</b>	N/A		CK-52-NAT <b>\$16</b>	CK-54-LP <b>\$25</b>	CK-56-NAT <b>\$16</b>	CK-58-LP <b>\$25</b>
435, 735, 736	HCK-02-NAT <b>\$176</b>	HCK-02-LP <b>\$176</b>	MCK-02-NAT <b>\$34</b>	MCK-02-LP <b>\$34</b>	N/A		CK-12-NAT <b>\$16</b>	CK-15-LP <b>\$25</b>	CK-21-NAT <b>\$16</b>	CK-24-LP <b>\$25</b>
731	HCK-03-NAT <b>\$223</b>	HCK-03-LP <b>\$243</b>	MCK-03-NAT <b>\$68</b>	MCK-03-LP <b>\$75</b>	CK-71-NAT <b>\$84</b>	CK-73-LP <b>\$95</b>	CK-51-NAT <b>\$64</b>	CK-53-LP <b>\$64</b>	CK-55-NAT <b>\$64</b>	CK-57-LP <b>\$64</b>
<b>FIRE URNS &amp; LANTERNS</b>										
520, 530	N/A		MCK-01-NAT <b>\$68</b>	MCK-01-LP <b>\$75</b>	N/A		CK-11-NAT <b>\$64</b>	CK-13-LP <b>\$64</b>	CK-20-NAT <b>\$64</b>	CK-22-LP <b>\$64</b>
716	HCK-05-NAT <b>\$216</b>	HCK-05-LP <b>\$216</b>	MCK-05-NAT <b>\$68</b>	MCK-05-LP <b>\$68</b>	N/A		CK-16-NAT <b>\$64</b>	CK-17-LP <b>\$64</b>	CK-25-NAT <b>\$64</b>	CK-26-LP <b>\$64</b>

## American Fyre Designs Burners

BURNER DESCRIPTION	MODEL #	BTU's		PRICE
		N.G.	L.P.	
12" Star Burner * (Without Valve) LP	<b>OCBS-12P</b>	--	50k	<b>\$123</b>
12" Star Burner * (Without Valve) NAT	<b>OCBS-12</b>	60k	--	<b>123</b>
16" Star Burner ** (Without Valve) LP	<b>OCBS-16P</b>	--	60k	<b>144</b>
16" Star Burner ** (Without Valve) NAT	<b>OCBS-16</b>	65k	--	<b>144</b>

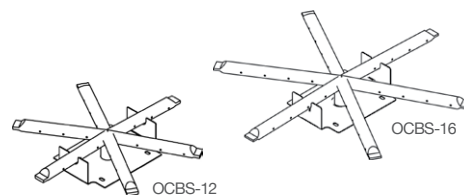

\* Also used as replacement for most firetables on pages 6, 7 & 8.

\*\* Also used as replacement for Cosmo. Square Dining (pg. 8), most Fire Bowls (pg. 9), and most Fire Pits (pg. 10).

## FIREPLACE PART NUMBER BREAK DOWN & ORDERING GUIDE

**882**

Fireplace Style  
PAGE 2-3

-

**35**

Hearth Style  
PAGE 2

-

**N**

Recess Option

**N** = No Recess  
**H** = Hearth Only  
**A** = Hearth & Body

-

**CB**

Color Choice  
PAGE 4

-

**RB**

Gas Shut Off  
PAGE 4

**C**

Crating

**Follow these step-by-step guidelines to configure the right fireplace for you.**

**Step 1 - Fireplace Style** - Select your fireplace style (vented or vent-free).

**Step 2 - Hearth Style** - The fireplace rests on a hearth base – select the size and style that suits your application.

**Step 3 - Recess Option** - Some AFD fireplaces may be clad with your own finishing materials like stone or brick. For these units, you may select the “recess” option to accommodate such materials.

**Step 4 - Color Choice** - Choose your finish which comes in five finish color options.

**Step 5 - Gas Shut Off & Line Location** - Determine where your gas shut off control and line should be positioned.

**Step 6 - Select Media Type and Burner** - logs or glass media in natural gas or propane suitable for fireplace chosen (vented or vent-free)

- Optional fireplace accessories shown on page 4 & 5 - consider adding a cover, screen or rain cap.
- Note: All fireplaces are crated for shipment.

## FIRETABLES, PITS, BOWLS, & URNS PART NUMBER BREAK DOWN & ORDERING GUIDE

**782**

Fire Feature Style  
PAGE 6-11

-

**CB**

Color Choice  
PAGE 11

-

**11**

Top Style

**11** = GFRC  
**FO** = French Barrel Oak  
**SP** = Silver Pine

-

**M2**

Valves

**H** = FyreStarter  
**M** = Manual Flame Sensing Control w/ spark igniter

**N**

Gas Type

**N** = Natural  
**P** = Propane

**C**

Crating

**Follow these step-by-step guidelines to configure the right product for you.**

**Step 1 - Fire Feature Style** - Select the AFD fire feature you desire.

**Step 2 - Color Choice** - Choose your finish which comes in five finish color options and three antique finish options.

**Step 3 - Top Style** - Choose your top style (available for select firetable models only).

**Step 4 - Gas Type** - Choose either Natural gas (**N**) or propane (**P**).

**Step 5 - Select Media Type** - Gas logs, stones, lava, or glass media.

- Consider adding a cover - see page 14.
- Note: All firetables, fire pits, fire bowls, and fire urns are crated for shipment.

**ALL AMERICAN Fyre DESIGNS™ PRODUCTS ARE MADE TO ORDER AND CANNOT BE CANCELED.**

American Fyre Designs™ products are certified to ANSI Z21.97-2017 and CSA 2.41 as outdoor decorative gas appliances.

**AFD PRODUCTS ARE FOR OUTDOOR USE ONLY**

### AMERICAN Fyre DESIGNS™ LIMITED WARRANTY HIGHLIGHTS

#### THREE (3) YEAR WARRANTY

American Fyre Designs™ exterior (GFRC) Fireplaces, Firetables, Fire Bowls, Fire Urns, and Fire Pits are warranted for three (3) years.

#### ONE (1) YEAR WARRANTY

American Fyre Designs™ burners, electronic components, and valves are warranted for one (1) year.

*This warranty applies to the original purchaser with invoice or proof of purchase and to single family residential use only. For additional information regarding this warranty, or to place a warranty claim contact your authorized AFD dealer*

This price list may not be copied, photocopied, reproduced, translated, or published in any electronic or machine-readable form in whole or in part without prior written approval of Robert H. Peterson Co.

**RH PETERSON CO.**

14724 Proctor Ave • City of Industry, CA 91746 • Website: www.rhpeterson.com • (626) 369-5085 • Fax (626) 369-5979